

Marsh Furniture Specifications Guide

February 2, 2015



MARSH CABINETS



MARSH PRODUCT WARRANTY FIVE (5) YEAR LIMITED WARRANTY

Marsh Furniture Company (“Marsh”) warrants to the original user for “Household Use” only as defined below that for a five (5) year term, measured from the date of purchase from Marsh, Marsh will repair or replace any product of Marsh’s manufacture which is defective in material and workmanship. The term “Household Use” shall include use for personal and family purposes as well as in hotel or motel residential short term rental units, but does not apply to other purposes for commercial use. The remedy of repair or replacement (which shall be at the option of Marsh) is the exclusive remedy of the user. Claims for repair or replacement should be submitted to Marsh at P.O. Box 870, High Point, NC, 27261-0870.

It is the nature of wood products to have variations in the grain pattern and wood color. Any surface finish may be affected by exposure to sunlight and other elements as part of the natural aging process. These material variations and changes are not covered by this warranty. Proper care and use are essential to preserving your rights to this Warranty. Marsh will not repair or replace any product if damage is caused by improper use or maintenance such as the use of abrasives or harsh cleaning agents on cabinet surfaces.

Additionally, this warranty does not cover damage to Marsh products from negligence, abuse, normal wear and tear, accidents, trauma, fire, water damage, or other catastrophe, or if a product is routinely subjected to steam or unusually high humidity. Costs related to damages incurred in transit, handling, installation, and all costs related to the transportation, removal or reinstallation of defective Marsh products are not assumed by Marsh under this Warranty.

MARSH MAKES NO IMPLIED WARRANTIES OF MERCHANTABILITY OR OF FITNESS FOR A PARTICULAR PURPOSE. THESE AND ALL OTHER IMPLIED WARRANTIES ARE SPECIFICALLY DISCLAIMED. IN NO EVENT WILL MARSH BE LIABLE FOR CONSEQUENTIAL, INDIRECT OR INCIDENTAL DAMAGES RESULTING FROM ANY CAUSE.

Some states do not allow limitations on how long an implied warranty lasts and some states do not allow an exclusion or limitation of incidental or consequential damages, so the above limitations or exclusions may not apply to you. This warranty gives you specific legal rights, and you may also have other rights which vary from state to state.

- SECTION 1 WALLS**
- SECTION 2 BASES**
- SECTION 3 TALLS**
- SECTION 4 VANITIES**
- SECTION 5 ACCESSORIES**
- SECTION 6 SALES AIDS**
- SECTION 7 CARE AND MAINTENANCE**
- SECTION 8 SUPPLY ORDER PARTS REFERENCE**
- SECTION 9 GLASS CUT FOR SIZE**

TABLE OF CONTENTS AND ABBREVIATIONS

Abbrev.	Description	Page	Abbrev.	Description	Page
20 Door Wall Pager.	Door Pager.....	6.02	D		
50, 45	Sales Samples.....	6.02	D2B	Drawer Base - 2 Drawer	2.05
54 Door Pager.	Door Pager.....	6.02	D3B	Drawer Base - 3 Drawer	2.04
			D4B	Drawer Base - 4 Drawer	2.04
A			DCB	Decorative Counter Bracket	5.15
ACOR	Acanthus Corbel	5.15	DCK	Ductless Conversion Kit	1.21
ADSR	Adjustable Door Spice Rack.....	1.20	DM	Dentil Molding	5.09
AFAD	Furniture Apron - Double Arch Scalloped	5.12	DMK	Door Mounting Kit - Waste Basket	2.13
AFAS	Furniture Apron - Single Arched.....	5.13	DO	Desk Organizer	1.19
AH	Appliance Hutch	1.19	DSB	Diagonal Sink Base	2.05
APL	Apple Foot	5.15	DSCK	Blumotion Compact Soft Close Set.....	5.17
AV	Arched Valance	5.12	DWB	Double Waste Baskets	2.13
			DWE	Dishwasher End Panel	5.08
B			DWEP	Dishwasher End Panel Profiled Filler Overlay..	5.08
BAFFL	Base Angled Filler - Fluted	5.05	E		
BBP	Bead Board Panel	5.17	EDGE BAND	Edge Band	5.18
BCF	Bookcase Cabinet	1.18	EM	Edge Molding	5.08
BCPO	Blind Corner Pullout Organizer.....	2.15	EZCB	Easy Reach Corner Base	2.07
BCWN	Beaded Crown Molding	5.10	EZCW	Easy Reach Corner Wall Cabinet	1.15
BCWNC	Beaded Crown Molding - Full Overlay	5.10	EZDCB	Easy Reach Diagonal Corner Base	2.07
BEC	Base End Cabinet	2.08	F		
BFB	Base Filler Box	5.03	FB	Facia Board	5.17
BFC	Base Fluted Column	5.04	FBFOL	Furniture Base Molding - Full Overlay	5.11
BFFL	Base Filler - Fluted	5.05	FBSOL	Furniture Base Molding - Standard Overlay ...	5.11
BFH	Base Full Height Cabinet.....	2.02	FBMLDGCLEAT	Furniture Base Attachment Cleat	5.11
BFHBP	Base Full Height Cabinet with Bi-Parting Doors	2.02	FP	Finished Panel	5.17
BFPO	Base Filler Pullout Organizer	2.14	FPC	Finished Panel Crossgrain	5.17
BFWD	Base Filler (Wood)	5.04	FSB	Farm Sink Base.....	2.03
BFWDP	Base Filler (Wood) with Profiled Overlay	5.07	FSBBP	Farm Sink Base with Bi-Parting Doors	2.03
BM	Batten Molding	5.09	FSFL	Filler Strip - Fluted	5.05
BPO	Base Pullout Organizer	2.14	FV	Frieze Valance	5.12
BSB	Burner Sink Base	2.03	G		
BSBBP	Burner Sink Base with Bi-Parting Doors	2.03	GR	Galley Rail	5.09
BSF	Base Sink Fronts.....	2.10	GRCL	Grape Cluster	5.14
BTC	Base Transitional Cabinet	2.08	GRCOR	Grape Corbel	5.14
BX	Installation Items	5.18	H		
C			HS	Heat Shields	5.18
CAR	Lazy Susan Barrel Cabinet	2.07	I		
CBFWD	Corner Base Filler (Wood)	5.04	IB	Island Base	2.08
CBFWDP	Corner Base Filler (Wood) with Profiled Overlay	5.07	IBBP	Island Base with Bi-Parting Doors	2.08
CM	Cap Molding	5.09	IFH	Island Full Height	2.09
CR	Corner Round Molding (Outside Corner)	5.09	IFHBP	Island Full Height with Bi-Parting Doors.....	2.09
CRA	Corner Round Molding.....	5.09	ISB	Island Sink Base	2.09
CS	Corner Shelf	1.19	ISBBP	Island Sink Base with Bi-Parting Doors	2.09
CSF	Corner Sink Front	2.10	IW	Island Wall Cabinets.....	1.10
CSTP	Corner Shelf Top Plate	1.19	IWBP	Island Wall Cabinets with Bi-Parting Doors....	1.10
CTEM	Counter Top Edge Molding	5.09	IWBPG	Island Wall Cabinets with Bi-Parting Glass Doors	1.10
CTP	Corner Toe Plate	5.17	IWBPM	Island Wall Cabinets with Bi-Parting Mullion Doors	1.10
CV	Cove Molding	5.09	IWGL	Island Wall Cabinets with Glass Doors.....	1.10
CWC	Corner Wall Cabinet (Diagonal)	1.15	IWMD	Island Wall Cabinets with Mullion Doors	1.10
CWCGL	Corner Wall Cabinet (Diagonal) with Glass Doors	1.15			
CWCMD	Corner Wall Cabinet (Diagonal) with Mullion Doors	1.15			
CWN	Crown Molding (Small)	5.10			

TABLE OF CONTENTS AND ABBREVIATIONS

Abbrev.	Description	Page	Abbrev.	Description	Page
K			K		
KC	Vanity Tops	4.09	RP	Refrigerator End Panel	5.08
L			L		
LB	Light Bar Trim Molding	5.09	RPBC	Reversible Pantry Base Corner	2.06
LBCP	LeMans Corner Pullout	2.15	RST30/42/84	Split Turning Reed Center	5.16
LBM	Individual Finish Box Samples	6.02	RTPF	Range Toe Plate	5.17
LCV	Large Cove Molding	5.10	RTU	Roll Out Tray	2.11
LCVC	Large Cove Crown	5.10	RW	Refrigerator Wall Cabinets	1.11-1.12
LCWNC	Large Crown Molding w/Heel	5.11	RWBP	Refrigerator Wall Cabinets with Bi-Parting Doors	1.12
LES	Left End Splash	4.09	RWBPG	Refrigerator Wall Cabinets with Bi-Parting Glass Doors	1.12
LLE	Loose Laminated Ends	5.03	RWBPM	Refrigerator Wall Cabinets with Bi-Parting Mullion Doors	1.12
LONLAYA	Large Acanthus Onlay	5.13	RWGL	Refrigerator Wall Cabinets with Glass Doors	1.11-1.12
LONLAYGR	Large Grape Onlay	5.14	RWMD	Refrigerator Wall Cabinets with Mullion Doors	1.11-1.12
LS	Loose Shelving	5.17	S		
LSC	Wood Shelving Cleats	5.17	SBM	Shoe Base Molding	5.09
LSCB	Lazy Susan Corner Base	2.07	SBX	Sample Box Only	6.02
LSCBFP	Loose Profiled Filler for Base Corner	5.06	SBXC	Complete Sample Box of Finishes	6.02
LSDCB	Lazy Susan Diagonal Corner Base	2.07	SCMC	Shaker Crown Molding	5.10
LSUFP	Loose Profiled Filler for Walls, Bases & Talls	5.06	SCR	Small Outside Corner	5.09
LSOCFP	Oven Cabinet Profiled Filler	3.05	SD	Sample Door, no bore	6.02
LSVFP	Loose Profiled Filler for Vanity Bases	5.06	SF	Soffit Molding	5.09
M			S		
MKC	Vanity Tops	4.09	SFA	Straight Furniture Apron	5.12
MLDGCLEAT	Molding Cleat - Single	5.11	SFE	Sink Front End Panel	5.08
MLDGCLEATBX	Molding Cleat - Box	5.11	SFF	Sink Front Floors	2.10
MWB	Microwave Bases	2.04	SH	Stemware Holder	1.20
O			S		
OC	Oven Cabinet	3.03	SHCOR	Shaker Corbels	5.15
OE	Overlay Ends	5.02	SM	Scribe Molding	5.09
ONLAYA3	Small Acanthus Ornament	5.13	SMC	Sample Molding Chain	6.02
ONLAYA6	Large Acanthus Ornament	5.13	SONLAYGR	Small Grape Onlay	5.14
OVD	Overlay Door - Base	5.02	SPDBX	Spice Drawer Box	1.19
OVDUC	Overlay Door - Utility Cabinet	5.02	SPWC	Spice Drawer Cabinet/Wine Cube	1.19
OVDV	Overlay Door - Vanity (Standard)	5.02	SSB	Sink Pantry Base	2.04
OVDVBH	Overlay Door - Vanity (Base Height)	5.02	SSCB	Super Susan Corner Base	2.07
OVDW	Overlay Door - Wall	5.02	SSCM	Shaker Crown Molding	5.09
P			S		
PB	Pantry Base	2.02	SSCV	Solid Scalloped Valance Wood	5.12
PBBP	Pantry Bases with Bi-Parting Doors	2.02	SSDCB	Super Susan Diagonal Corner Base	2.08
PD	Sample Door, hinged for pager	6.02	SSV	Straight Valance (painted white)	5.12
PFT	Plain Full Turning	5.16	STR	Wood Moldings - Starter Molding	5.11
PST	Split Turning End Post	5.16	SV	Straight Valance	5.12
PST30/42/84	Split Turning Plain Center	5.16	SWB	Single Waste Basket	2.13
R			T		
REP	Refrigerator End Panel	5.08	TBSM	Triple Bead Stacked Molding	5.11
RES	Right End Splash	4.09	TFB	Tall Filler Box	5.03
RFT	Reeded Full Turning	5.16	TFC	Tall Fluted Column	5.04
RH	Range Hood	1.21	TK	Toe Kick	5.17
RHB	Range Hood Blower	1.21	TLG	2-Sided Taper Leg	5.15
RLR	Radius Light Rail Molding	5.11	TLL	Tulip Foot	5.15
RLS	Round Lazy Susan	1.20	TP	Toe Plate	5.17
RM	Rope Molding	5.09	TPEC	Toe Plate End Cap	5.17
ROS3	Rosette	5.15	U		
			UC	Utility Cabinet	3.02
			UCBP	Utility Cabinet with Bi-Parting Doors	3.02
			UC3S	Utility Cabinet Three Shelf Kit	3.05

TABLE OF CONTENTS AND ABBREVIATIONS

Abbrev.	Description	Page	Abbrev.	Description	Page
UCT	Under Cabinet Trim	5.09	WCBPGL	Wall Cabinets with Bi-Parting Glass Doors	1.02-1.06, 1.08-1.09
UCWN	Universal - Crown Molding	5.10	WCBPMD	Wall Cabinets with Bi-Parting Mullion Doors	1.02-1.06, 1.08-1.09
UCWNC	Universal - Crown Molding - Full Overlay	5.10	WCC	Wall Corner Cabinet	1.13-1.14
UFWD	Universal Filler (Wood)	5.04-5.05, 5.07	WCCGL	Wall Corner Cabinet with Glass Doors	1.13-1.14
UFWDP	Universal Filler (Wood) with Profiled Overlay	5.06-5.07	WCCMD	Wall Corner Cabinet with Mullion Doors	1.13-1.14
V					
V	Scalloped Valance - Oak Only	5.12	WCGL	Wall Cabinet with Glass Doors	1.02-1.06, 1.07-1.09
V3D	Vanity with 3 Drawers	4.08	WCM	Wall Microwave Cabinet	1.18
V3DBH	Vanity, Base High with 3 Drawers	4.08	WCMD	Wall Cabinet with Mullion Doors	1.02-1.06, 1.07-1.09
V4DBH	Vanity, Base High with 4 Drawers	4.08	WCMW	Wall Cabinet for Microwave	1.17
VB	Vanity Base	4.05	WCMWBP	Wall Cabinet for Microwave with Bi-Parting Doors	1.17-1.18
VBBH	Vanity Base, Base High	4.05	WCMWBPGL	Wall Cabinet for Microwave with Bi-Parting Glass Doors	1.17-1.18
VBBP	Vanity Base with Bi-Parting Doors	4.06	WCMWBPM	Wall Cabinet for Microwave with Bi-Parting Mullion Doors	1.17-1.18
VBBPBH	Vanity Base, Base High with Bi-Parting Doors	4.06	WCMWGL	Wall Cabinet for Microwave with Glass Doors	1.17
VBFFL	Vanity Base Filler - Fluted	5.05	WCMWMD	Wall Cabinet for Microwave with Mullion Doors	1.17
VDL	Vanity Drawer Lavatory	4.07-4.08	WCPRF	Wall Cabinet w/Plate Rack	1.18
VDLBH	Vanity Drawer Lavatory - Base Height	4.07-4.08	WCWN	Wood Crown Molding	5.10
VDLBP	Vanity Drawer Lavatory with Bi-Parting Doors	4.07	WDCT	Wood Cutlery Tray	2.15
VDLBPBH	Vanity Drawer Lavatory, Base High with Bi-Parting Doors	4.07	WDDWB	Wood Double Waste Basket	2.13
VDU	Vanity Drawer Unit	4.09	WDRTU	Wood Roll Out Tray	2.12
VFB	Vanity Filler Box	5.03	WDSI	Spice Drawer Insert	2.15
VFBBH	Vanity Filler Box - Base Height	5.03	WDSWB	Wood Single Waste Basket	2.13
VFC	Vanity Fluted Column	5.04	WDUT	Wood Utility Tray	2.15
VFCBH	Vanity Fluted Column - Base Height	5.04	WEA	Wall End Angled Cabinet	1.16
VFD	Vanity File Drawer	4.09	WEAGL	Wall End Angled Cabinet with Glass Doors	1.16
VFDBH	Vanity File Drawer, Base High	4.09	WEC	Wall End Cabinet	1.16
VFH	Vanity Full Height	4.02-4.03	WECGL	Wall End Cabinet with Glass Doors	1.16
VFHBH	Vanity Full Height, Base High	4.02-4.03	WECMD	Wall End Cabinet with Mullion Doors	1.16
VFHBP	Vanity Full Height with Bi-Parting Doors	4.02-4.03	WFB	Wall Filler Box	5.03
VFHBPBH	Vanity Full Height, Base High with Bi-Parting Doors	4.02-4.03	WFC	Wall Fluted Column	5.03
VFWDP	Universal Filler (Wood) with Profiled Overlay	5.07	WFPO	Wall Filler Pullout Organizer	1.20
VLEGF	Vanity Desk Leg	4.09	WR	Wine Rack	1.20
VL	Vanity Lavatory Front	4.09	WRCF	Lattice Wine Rack Cabinet	1.18
VLFBP	Vanity Lavatory Front with Bi-Parting Doors	4.09		Touch-up Aerosol Spray and Stain	5.18
VS	Vanity Sink	4.04		Dealer Binder	6.02
VSBH	Vanity Sink, Base High	4.04		Door Sample Bags	6.02
VSBP	Vanity Sink with Bi-Parting Doors	4.04-4.05		Mini Bases	6.02
VSBPBH	Vanity Sink, Base High with Bi-Parting Doors	4.04-4.05		Care and Maintenance	7.01
VSD	Vanity Side Drawer	4.06		Cabinet Modifications	0.27
VSDBH	Vanity Side Drawer - Base Height	4.07			
VSV	Straight Valance - Veneered MDF	5.12			
VWC	Vanity Wall Cabinet	4.10			
W					
WC	Wall Cabinet	1.02-1.09			
WCBP	Wall Cabinets with Bi-Parting Doors	1.02-1.06, 1.08-1.09			

TABLE OF CONTENTS BY SECTION

WALL CABINETS

WALLS

WC	Wall Cabinet	1.02-1.09
WCBP	Wall Cabinets with Bi-Parting Doors	1.02-1.06, 1.08-1.09
WCBPGL	Wall Cabinets with Bi-Parting Glass Doors	1.02-1.06, 1.08-1.09
WCBPMD	Wall Cabinets with Bi-Parting Mullion Doors	1.02-1.06, 1.08-1.09
WCGL	Wall Cabinet with Glass Doors	1.02-1.06, 1.07-1.09
WCMD	Wall Cabinet with Mullion Doors	1.02-1.06, 1.07-1.09
WEA	Wall End Angled Cabinet	1.16
WEAGL	Wall End Angled Cabinet with Glass Doors	1.16
WEC	Wall End Cabinet	1.16
WECGL	Wall End Cabinet with Glass Doors	1.16
WECMD	Wall End Cabinet with Mullion Doors	1.16

CORNER WALLS

CWC	Corner Wall Cabinet (Diagonal)	1.15
CWCGL	Corner Wall Cabinet (Diagonal) with Glass Doors	1.15
CWCMD	Corner Wall Cabinet (Diagonal) with Mullion Doors	1.15
EZCW	Easy Reach Corner Wall Cabinet	1.15
WCC	Wall Corner Cabinet	1.13-1.14
WCCGL	Wall Corner Cabinet with Glass Doors	1.13-1.14
WCCMD	Wall Corner Cabinet with Mullion Doors	1.13-1.14

ISLAND WALLS

IW	Island Wall Cabinets	1.10
IWBP	Island Wall Cabinets with Bi-Parting Doors	1.10
IWBPG	Island Wall Cabinets with Bi-Parting Glass Doors	1.10
IWBPM	Island Wall Cabinets with Bi-Parting Mullion Doors	1.10
IWGL	Island Wall Cabinets with Glass Doors	1.10
IWMD	Island Wall Cabinets with Mullion Doors	1.10

MICROWAVE WALLS

WCMW	Wall Cabinet for Microwave	1.17
WCMWBP	Wall Cabinet for Microwave with Bi-Parting Doors	1.17-1.18
WCMWBPG	Wall Cabinet for Microwave with Bi-Parting Glass Doors	1.17-1.18
WCMWBPM	Wall Cabinet for Microwave with Bi-Parting Mullion Doors	1.17-1.18
WCMWGL	Wall Cabinet for Microwave with Glass Doors	1.17
WCMWMD	Wall Cabinet for Microwave with Mullion Doors	1.17

REFRIGERATOR WALLS

RW	Refrigerator Wall Cabinets	1.11-1.12
RWBP	Refrigerator Wall Cabinets with Bi-Parting Doors	1.12
RWBPG	Refrigerator Wall Cabinets with Bi-Parting Glass Doors	1.12
RWBPM	Refrigerator Wall Cabinets with Bi-Parting Mullion Doors	1.12

RWGL	Refrigerator Wall Cabinets with Glass Doors	1.11-1.12
RWMD	Refrigerator Wall Cabinets with Mullion Doors	1.11-1.12

WALL ACCESSORIES

ADSR	Adjustable Door Spice Rack	1.20
AH	Appliance Hutch	1.19
BCF	Bookcase Cabinet	1.18
CS	Corner Shelf	1.19
CSTP	Corner Shelf Top Plate	1.19
DO	Desk Organizer	1.19
SH	Stemware Holder	1.20
WCM	Wall Microwave Cabinet	1.18
WCPRF	Wall Cabinet with Plate Rack	1.18
WFPO	Wall Filler Pullout Organizer	1.20
WR	Wine Rack	1.20
WRCF	Lattice Wine Rack Cabinet	1.18
RLS	Round Lazy Susan	1.20
SPDBX	Spice Drawer Box	1.19
SPWC	Spice Drawer Cabinet/Wine Cube	1.19
DSCK	Blumotion Compact Soft Close Set	5.17

RANGE HOODS

RH	Range Hood	1.21
RHB	Range Hood Blower	1.21
DCK	Ductless Conversion Kit	1.21

BASE CABINETS

BASES

BEC	Base End Cabinet	2.08
BFH	Base Full Height Cabinet	2.02
BFHBP	Base Full Height Cabinet with Bi-Parting Doors	2.02
BSB	Burner Sink Base	2.03
BSBBP	Burner Sink Base with Bi-Parting Doors	2.03
FSB	Farm Sink Base	2.03
FSBBP	Farm Sink Base with Bi-Parting Doors	2.03
BTC	Base Transitional Cabinet	2.08
D4B	Drawer Base - 4 Drawer	2.04
D3B	Drawer Base - 3 Drawer	2.04
D2B	Drawer Base - 2 Drawer	2.05
DSB	Diagonal Sink Base	2.05
PB	Pantry Base	2.02
PBBP	Pantry Bases with Bi-Parting Doors	2.02
SSB	Sink Pantry Base	2.04
BSF	Base Sink Fronts	2.10
SFF	Sink Front Floors	2.10

CORNER BASE

CAR	Lazy Susan Barrel Cabinet	2.07
CSF	Corner Sink Front	2.10
EZCB	Easy Reach Corner Base	2.07
EZDCB	Easy Reach Diagonal Corner Base	2.07
LSCB	Lazy Susan Corner Base	2.07
LSDCB	Lazy Susan Diagonal Corner Base	2.07
RPBC	Reversible Pantry Base Corner	2.06
SSCB	Super Susan Corner Base	2.07
SSDCB	Super Susan Diagonal Corner Base	2.08

ISLAND BASE

IB	Island Base	2.08
IBBP	Island Base with Bi-Parting Doors	2.08
IFH	Island Full Height	2.09
IFHBP	Island Full Height with Bi-Parting Doors	2.09

TABLE OF CONTENTS BY SECTION

ISB.....	Island Sink Base.....	2.09	VLFBP.....	Vanity Lavatory Front with Bi-Parting Doors .	4.09
ISBBP.....	Island Sink Base with Bi-Parting Doors.....	2.09	VS.....	Vanity Sink.....	4.04
BASE ACCESSORIES			VSBH.....	Vanity Sink, Base High.....	4.04
BCPO.....	Blind Corner Pullout Organizer.....	2.15	VSBP.....	Vanity Sink with Bi-Parting Doors.....	4.04-4.05
BFPO.....	Base Filler Pullout Organizer.....	2.14	VSBPBH.....	Vanity Sink, Base High with Bi-Parting Doors.....	4.04-4.05
BPO.....	Base Pullout Organizer.....	2.14	VANITY MISCELLANEOUS		
LBCP.....	LeMans Corner Pullout.....	2.15	VLEGF.....	Vanity Desk Leg.....	4.09
RTU.....	Roll Out Tray.....	2.11	VDU.....	Vanity Drawer Unit.....	4.09
WDRTU.....	Wood Roll Out Tray.....	2.12	DECORATIVE DOORS		
SWB.....	Single Waste Basket.....	2.13	OVDW.....	Overlay Door - Wall.....	5.02
WDSWB.....	Wood Single Waste Basket.....	2.13	OVDDB.....	Overlay Door - Base.....	5.02
DWB.....	Double Waste Baskets.....	2.13	OVDUC.....	Overlay Door - Utility Cabinet.....	5.02
WDDWB.....	Wood Double Waste Basket.....	2.13	OVDV.....	Overlay Door - Vanity (Standard).....	5.02
DMK.....	Door Mounting Kit - Waste Basket.....	2.13	OVDVBH.....	Overlay Door - Vanity (Base Height).....	5.02
WDCT.....	Wood Cutlery Tray.....	2.15	FILLERS		
WDSI.....	Spice Drawer Insert.....	2.15	WALL FILLERS		
WDUT.....	Wood Utility Tray.....	2.15	FSFL.....	Filler Strip - Fluted.....	5.05
TALL CABINETS			LSUFP.....	Loose Profiled Filler for Walls, Bases & Talls.....	5.06
OVEN CABINETS			RP.....	Refrigerator End Panel.....	5.08
OC.....	Oven Cabinet.....	3.03	REP.....	Refrigerator End Panel.....	5.08
UTILITY CABINETS			WFB.....	Wall Filler Box.....	5.03
UC.....	Utility Cabinet.....	3.02	WFC.....	Wall Fluted Column.....	5.03
UCBP.....	Utility Cabinet with Bi-Parting Doors.....	3.02	BASE FILLERS		
TALL ACCESSORIES			DWEP.....	Dishwasher End Panel Profiled Filler Overlay.....	5.08
UC3S.....	Utility Cabinet Three Shelf Kit.....	3.05	BFB.....	Base Filler Box.....	5.03
VANITY CABINETS			BFC.....	Base Fluted Column.....	5.04
WALLS			BFFL.....	Base Filler - Fluted.....	5.05
VWC.....	Vanity Wall Cabinet.....	4.10	BAFFL.....	Base Angled Filler - Fluted.....	5.05
BASES			OVEN FILLERS		
V3D.....	Vanity Drawer Base.....	4.08	LSOCFP.....	Oven Cabinet Profiled Filler.....	3.05
V3DBH.....	Vanity, Base High with 3 Drawers.....	4.08	TALL FILLERS		
V4DBH.....	Vanity Drawer - Base Height.....	4.08	TFB.....	Tall Filler Box.....	5.03
VB.....	Vanity Base.....	4.05	TFC.....	Tall Fluted Column.....	5.04
VBBH.....	Vanity Base, Base High.....	4.05	FSFL.....	Filler Strip - Fluted.....	5.05
VBBP.....	Vanity Base with Bi-Parting Doors.....	4.06	UNIVERSAL FILLERS		
VBBPBH.....	Vanity Base, Base High with Bi-Parting Doors.....	4.06	BFWD.....	Base Filler (Wood).....	5.04
VFD.....	Vanity File Drawer.....	4.09	BFWDP.....	Base Filler (Wood) with Profiled Overlay....	5.07
VFDBH.....	Vanity File Drawer, Base High.....	4.09	CBFWD.....	Corner Base Filler (Wood).....	5.04
VFH.....	Vanity Full Height.....	4.02-4.03	CBFWDP.....	Corner Base Filler (Wood) with Profiled Overlay.....	5.07
VFHBH.....	Vanity Full Height, Base High.....	4.02-4.03	UFWD.....	Universal Filler (Wood).....	5.04-5.05, 5.07
VFHBP.....	Vanity Full Height with Bi-Parting Doors.....	4.02-4.03	UFWDP.....	Universal Filler (Wood) with Profiled Overlay.....	5.06-5.07
VLFBP.....	Vanity Lavatory Front with Bi-Parting Doors.....	4.09	VFWDP.....	Universal Filler (Wood) with Profiled Overlay.....	5.07
VFHBPBH.....	Vanity Full Height, Base High with Bi-Parting Doors.....	4.02-4.03	LSUFP.....	Flat Loose Profiled Filler for Walls, Bases & Talls.....	5.06
SINKS			LSCBFP.....	Flat Loose Profiled Filler for Base Corner...	5.06
VDL.....	Vanity Drawer Lavatory.....	4.07-4.08	LSOCFP.....	Oven Cabinet Profiled Filler.....	3.05
VDLBH.....	Vanity Drawer Lavatory - Base Height.....	4.07-4.08	LSVFP.....	Flat Loose Profiled Filler for Vanity Bases...	5.06
VDLBP.....	Vanity Drawer Lavatory with Bi-Parting Doors.....	4.07	VANITY FILLERS		
VDLBPBH.....	Vanity Drawer Lavatory, Base High with Bi-Parting Doors.....	4.07	VFB.....	Vanity Filler Box.....	5.03
VSD.....	Vanity Side Drawer.....	4.06	VFBBH.....	Vanity Filler Box - Base Height.....	5.03
VSDBH.....	Vanity Side Drawer - Base Height.....	4.07	VBFFL.....	Vanity Base Filler - Fluted.....	5.05
VLF.....	Vanity Lavatory Front.....	4.09			

TABLE OF CONTENTS BY SECTION

VFC	Vanity Fluted Column.....	5.04	GRCOR	Grape Corbel.....	5.14
VFCBH	Vanity Fluted Column - Base Height.....	5.04	LLE	Loose Laminated Ends.....	5.03
MOLDINGS			LONLAYA	Large Acanthus Onlay.....	5.13
BCWN	Beaded Crown Molding.....	5.10	LONLAYGR	Large Grape Onlay.....	5.14
BCWNC	Beaded Crown Molding - Full Overlay.....	5.10	OE	Overlay Ends.....	5.02
BM	Batten Molding.....	5.09	ONLAYA3	Small Acanthus Ornament.....	5.13
CM	Cap Molding.....	5.09	ONLAYA6	Large Acanthus Ornament.....	5.13
CR	Corner Round Molding (Outside Corner).....	5.09	PFT	Plain Full Turning.....	5.16
CRA	Corner Round Molding.....	5.09	PST	Split Turning End Post.....	5.16
CTEM	Counter Top Edge Molding.....	5.09	PST30/42/84	Split Turning Plain Center.....	5.16
CV	Cove Molding.....	5.09	RFT	Reeded Full Turning.....	5.16
CWN	Crown Molding (Small).....	5.10	ROS3	Rosette.....	5.15
DM	Dentil Molding.....	5.09	RST30/42/84	Split Turning Reed Center.....	5.16
EM	Edge Molding.....	5.08	SFA	Straight Furniture Apron.....	5.12
FBFOL	Furniture Base Molding - Full Overlay.....	5.11	SFE	Sink Front End Panel.....	5.08
FBSOL	Furniture Base Molding - Standard Overlay.....	5.11	SHCOR	Shaker Corbels.....	5.15
FBMLDGCLEAT	Furniture Base Attachment Cleat.....	5.11	SONLAYGR	Small Grape Onlay.....	5.14
GR	Galley Rail.....	5.09	SSCV	Solid Scalloped Valance Wood.....	5.12
LB	Light Bar Trim Molding.....	5.09	SSV	Straight Valance (painted white).....	5.12
LCV	Large Cove Molding.....	5.10	STR	Wood Moldings - Starter Molding.....	5.11
LCVC	Large Cove Crown - Full Overlay.....	5.10	SV	Straight Valance.....	5.12
LCWNC	Large Crown Molding with Heel.....	5.11	TLG	2-Sided Taper Leg.....	5.15
MLDGCLEATBX	Molding Cleat - Box.....	5.11	TLL	Tulip Foot.....	5.15
MLDGCLEAT	Molding Cleat - Single.....	5.11	V	Scalloped Valance - Oak Only.....	5.12
RLR	Radius Light Rail Molding.....	5.11	VSV	Straight Valance (veneered MDF).....	5.12
RM	Rope Molding.....	5.09	MISCELLANEOUS		
SCMC	Shaker Crown Molding - Full Overlay.....	5.10	20 Door Wall Pager. Door Pager.....	6.02	
SBM	Shoe Base Molding.....	5.09	50, 45	Sales Samples.....	6.02
SCR	Small Outside Corner.....	5.09	54 Door Pager. Door Pager.....	6.02	
SF	Soffit Molding.....	5.09	BX	Installation Items.....	5.18
SM	Scribe Molding.....	5.09	CTP	Corner Toe Plate.....	5.17
SSCM	Shaker Crown Molding.....	5.09	EDGEBAND	Edge Band.....	5.18
TBSM	Triple Bead Stacked Molding.....	5.11	HS	Heat Shields.....	5.18
UCT	Under Cabinet Trim.....	5.09	LBM	Individual Finish Box Sample.....	6.02
UCWN	Universal - Crown Molding.....	5.10	LS	Loose Shelving.....	5.17
UCWNC	Universal - Crown Molding - Full Overlay.....	5.10	LSC	Wood Shelving Cleats.....	5.17
WCWN	Wood Crown Molding.....	5.10	PD	Sample Door, hinged for pager.....	6.02
ACCESSORIES			RTPF	Range Toe Plate.....	5.17
ACOR	Acanthus Corbel.....	5.15	SBX	Sample Box Only.....	6.02
AFAD	Furniture Apron - Double Arch Scalloped.....	5.12	SBXC	Complete Sample Box of Finishes.....	6.02
AFAS	Furniture Apron - Single Arched.....	5.13	SD	Sample Door, no bore.....	6.02
APL	Apple Foot.....	5.15	SMC	Sample Molding Chain.....	6.02
AV	Arched Valance.....	5.12	TK	Toe Kick.....	5.17
BBP	Bead Board Panel.....	5.17	TP	Toe Plate.....	5.17
DCB	Decorative Counter Bracket.....	5.15	TPEC	Toe Plate End Cap.....	5.17
DWE	Dishwasher End Panel.....	5.08	Touch-up Aerosol Spray and Stain.....	5.18	
FB	Facia Board.....	5.17	Dealer Binder.....	6.02	
FP	Finished Panel.....	5.17	Door Sample Bags.....	6.02	
FPC	Finished Panel Crossgrain.....	5.17	Mini Bases.....	6.02	
FV	Frieze Valance.....	5.12	Care and Maintenance.....	7.01	
GRCL	Grape Cluster.....	5.14			

PRODUCT UPDATES

Nomenclature Changes

Previous	Current
DB	D4B
DBP	D3B
VD	V3D
VD-BH	V4D-BH
LCWN96	LCWN96C
LCWN144	LCWN144C
FA	AFA_D/AFA_S
Devonshire	Brunswick I Birch
Hillcrest	Florence Birch
Halifax	Cambridge Cherry
Woodland	Florence Cherry
Arch Woodland	Arch Florence Cherry

New Items

- Cambridge Maple, Cambridge Cherry
- Atlanta Maple, Atlanta Cherry
- Brunswick Birch, Brunswick Cherry
- Florence Birch, Florence Cherry
- Slate Glaze
- Two-Drawer Bases (D2B's)
- New Riser Molding (STR's)
- Expanded Mullion Door & Glass Door offerings
- Expanded Furniture Apron offerings
- Fairmont Plywood option
- Expanded Filler offerings
- Diagonal Sink cabinets
- Expanded Refrigerator panels
- Expanded SSCM offerings
- Expanded VFD options
- Supply Parts dimensions (found in back sections of this book)

BELWOOD and ARCH BELWOOD

Oak

- 3/4" thick door frame
- Traditional 1/2" overlay
- 2" stiles and rails
- Flat veneer center panel
- Roman arch flat veneer center panel on wall cabinets and Belwood door on base cabinets
- Concealed hinges

Drawers

- 3/4" thick solid front
- Side mounted guides
- Pulls not required



*Base cabinets are not available in Arch style

CAMBRIDGE

Oak, Birch, Maple, Cherry

- 3/4" thick door frame
- Traditional 1/2" overlay
- 2" stiles and rails
- Flat veneer center panel
- Concealed hinges

Drawers

- 3/4" thick solid front
- Side mounted guides
- Pulls not required

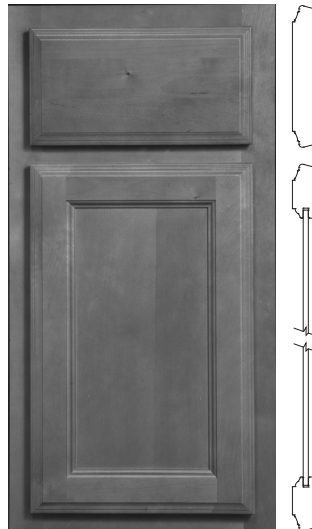

* Upgrade drawer option available: wood dovetail drawer with Full Extension, Soft Close feature

* See page 0.23 for additional specifications for painted product

CABINET REFERENCES—Standard Overlay

ATLANTA I

- Birch, Maple, Cherry
- 3/4" thick door frame
 - Traditional 1/2" overlay
 - 2" wide stiles and rails
 - Mortise and tenon construction with flat veneer center panel
 - Concealed hinges

Drawers

- 3/4" thick 5-piece drawer head with flat veneer center panel
- Side mounted guides
- Pulls not required

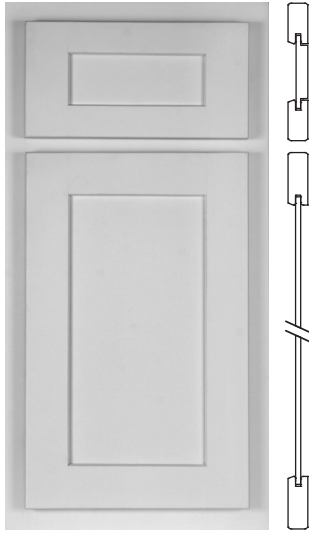

ATLANTA II

- Birch, Maple, Cherry
- 3/4" thick door frame
 - Traditional 1/2" overlay
 - 2" wide stiles and rails
 - Mortise and tenon construction with flat veneer center panel
 - Concealed hinges

Drawers

- 3/4" thick slab solid drawer head
- Side mounted guides
- Pulls not required



BRUNSWICK I

- Birch, Maple, Cherry
- 3/4" thick solid door frame
 - Traditional 1/2" overlay
 - 2-1/4" stiles and rails
 - Mitered corners
 - Flat veneer center panel
 - Concealed hinges

Drawers

- 3/4" thick solid front
- Side mounted guides
- Pulls not required

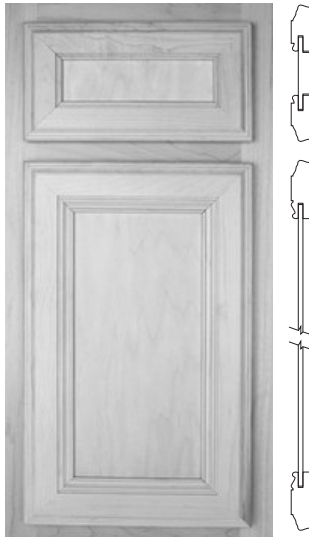

BRUNSWICK II

- Birch, Maple, Cherry
- 3/4" thick solid door frame
 - Traditional 1/2" overlay
 - 2-1/4" stiles and rails
 - Mitered corners
 - Flat veneer center panel
 - Concealed hinges

Drawers

- 3/4" thick solid front
- Side mounted guides
- Pulls not required



*Not available in Mullion

*Not available in Mullion

*All Drawer Bases will read Cambridge

* Upgrade drawer option available: wood dovetail drawer with Full Extension, Soft Close feature

* See page 0.23 for additional specifications for painted product

CABINET REFERENCES—Standard Overlay

PARKWOOD and ARCH PARKWOOD

Oak

- 3/4" thick door frame
- Traditional 1/2" overlay
- Raised center panel
- 2" stiles and rails
- Roman arch raised center panel on wall cabinets and Parkwood doors on base cabinets
- Concealed hinges

Drawers

- 3/4" thick solid front
- Side mounted guides
- Pulls not required



*Base cabinets are not available in Arch style

FLORENCE

Birch, Maple, Cherry

- 3/4" thick solid door frame
- Traditional 1/2" overlay
- Raised veneer center panel
- 2" stiles and rails
- Roman arch raised veneer center panel on wall cabinets and Florence door on base cabinets
- Concealed hinges

Drawers

- 3/4" thick solid front
- Side mounted guides
- Pulls not required



*Base cabinets are not available in Arch style

*Drawer Bases and Glass Door Cabinets will read Cambridge

ARCH FLORENCE

Maple, Cherry

- 3/4" thick solid door frame
- Traditional 1/2" overlay
- Raised veneer center panel
- 2" stiles and rails
- Roman arch raised veneer center panel on wall cabinets and Florence door on base cabinets
- Concealed hinges

Drawers

- 3/4" thick solid front
- Side mounted guides
- Pulls not required

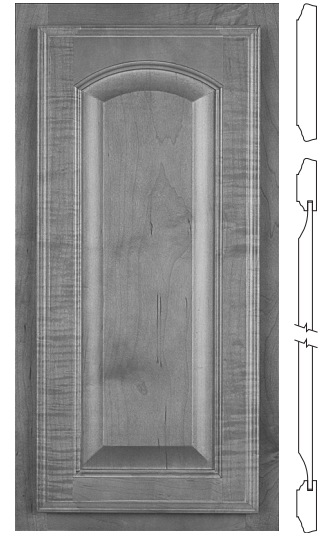

*Base cabinets are not available in Arch style

*Drawer Bases and Glass Door Cabinets will read Cambridge

* Upgrade drawer option available: wood dovetail drawer with Full Extension, Soft Close feature

* See page 0.23 for additional specifications for painted product

CABINET REFERENCES—Standard Overlay

FAIRMONT

Thermofoil

- 5/8" thick door frame
- Traditional 1/2" overlay
- Raised center panel
- 2-1/2" stiles and rails
- Thermofoil surface
- 3/4" thick painted hardwood frame
- Concealed hinges

Drawers

- 5/8" thick solid face
- Thermofoil surface
- Side mounted guides
- Pulls not required

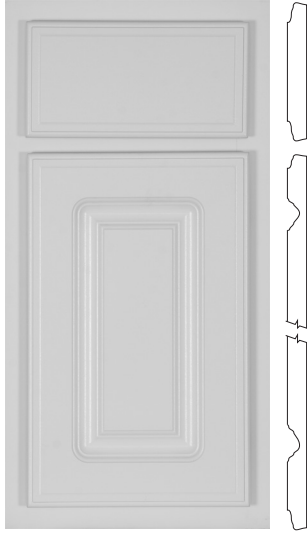

*Not available in Glass

* Upgrade drawer option available: wood dovetail drawer with Full Extension, Soft Close feature

* See page 0.23 for additional specifications for painted product

CABINET REFERENCES—Full Overlay

SAVANNAH I

- Maple and Cherry
- 3/4" thick solid door frame
 - Full overlay
 - Mortise and tenon door with flat veneer center panel
 - 2" stiles and rails
 - Soft Close hinges

Drawers

- 3/4" thick 5-piece solid drawer head
- Undermount, Full Extension Soft Close guides
- Pulls required

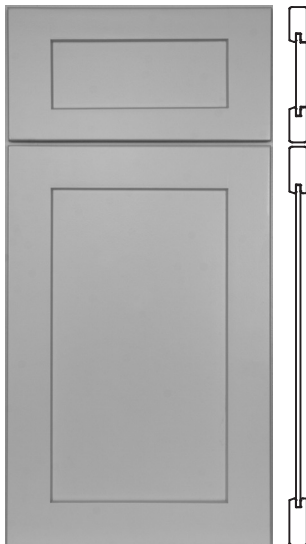

SAVANNAH II

- Maple and Cherry
- 3/4" thick solid door frame
 - Full overlay
 - Mortise and tenon door with flat veneer center panel
 - 2" stiles and rails
 - Soft Close hinges

Drawers

- 3/4" thick slab solid drawer head
- Undermount, Full Extension Soft Close guides
- Pulls required

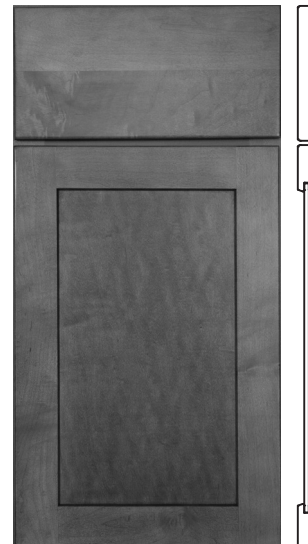

WILMINGTON I

- Maple and Cherry
- 3/4" thick solid door frame
 - Full overlay
 - Mitred door with flat veneer center panel
 - 2" stiles and rails
 - Soft Close hinges

Drawers

- 3/4" thick 5-piece drawer head
- Undermount, Full Extension Soft Close guides
- Pulls required



ARLINGTON I

- Maple and Cherry
- 3/4" thick solid door frame
 - Full overlay
 - Mitred door with raised veneer center panel
 - 2" stiles and rails
 - Soft Close hinges

Drawers

- 3/4" thick 5-piece drawer head
- Undermount, Full Extension Soft Close guides
- Pulls required



*Not available in Mullion

*Not available in Mullion

*Drawer Bases and Glass Door Cabinets will read Wilmington I

* De-selection of wood dovetail drawer with Full Extension, Soft Close feature available

* See page 0.23 for additional specifications for painted product

CABINET REFERENCES—Full Overlay

NANTUCKET I

Maple and Cherry

- 3/4" thick solid door frame
- Full overlay
- Mortise and tenon door with flat bead board center panel
- 2" stiles and rails
- Soft Close hinges

Drawers

- 3/4" thick 5-piece solid drawer head
- Undermount, Full Extension Soft Close guides
- Pulls required



- *Beads align between door and drawer
- *Glass Door Cabinets will read Savannah

NANTUCKET II

Maple and Cherry

- 3/4" thick solid door frame
- Full overlay
- Mortise and tenon door with flat bead board center panel
- 2" stiles and rails
- Soft Close hinges

Drawers

- 3/4" thick slab solid drawer head
- Undermount, Full Extension Soft Close guides
- Pulls required



- *Beads align between door and drawer
- *Drawer Bases will read Savannah II
- *Glass Door Cabinets will read Savannah

JAMESTOWN I

Maple and Cherry

- 3/4" thick solid door frame
- Full overlay
- Mortise and tenon door with flat veneer center panel
- 2" stiles and rails
- Soft Close hinges

Drawers

- 3/4" thick 5-piece solid drawer head
- Undermount, Full Extension Soft Close guides
- Pulls required



JAMESTOWN II

Maple and Cherry

- 3/4" thick solid door frame
- Full overlay
- Mortise and tenon door with flat veneer center panel
- 2" stiles and rails
- Soft Close hinges

Drawers

- 3/4" thick slab solid drawer head
- Undermount, Full Extension Soft Close guides
- Pulls required



* De-selection of wood dovetail drawer with Full Extension, Soft Close feature available
 * See page 0.23 for additional specifications for painted product

CABINET REFERENCES—Full Overlay

CHARLESTON I

Maple and Cherry

- 3/4" thick solid door frame
- Full overlay
- Mortise and tenon door with raised veneer center panel
- 2" stiles and rails
- Soft Close hinges

Drawers

- 3/4" thick 5-piece solid drawer head
- Undermount, Full Extension Soft Close guides
- Pulls required



*Drawer Bases and Glass Door Cabinets will read Jamestown I

CHARLESTON II

Maple and Cherry

- 3/4" thick solid door frame
- Full overlay
- Mortise and tenon door with raised veneer center panel
- 2" stiles and rails
- Soft Close hinges

Drawers

- 3/4" thick slab solid drawer head
- Undermount, Full Extension Soft Close guides
- Pulls required

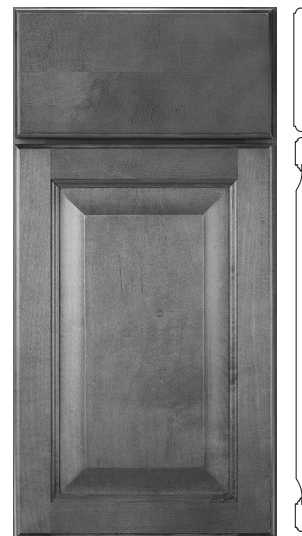

*Drawer Bases and Glass Door Cabinets will read Jamestown II

APEX

Maple and Cherry

- Full overlay
- 3/4" thick slab door with veneer surface
- Soft Close hinges

Drawers

- 3/4" thick slab drawer head in veneer
- Undermount, Full Extension Soft Close guides
- Pulls required

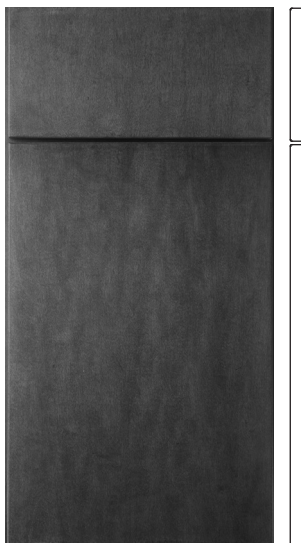

*Not available in Mullion and Glass Doors

*Vertical grain matches door and drawer

* De-selection of wood dovetail drawer with Full Extension, Soft Close feature available

* See page 0.23 for additional specifications for painted product

CABINET REFERENCES—Full Overlay

SUMMERFIELD I

Maple and Cherry

- 3/4" thick solid door frame
- Full overlay
- Mortise and tenon door with flat veneer center panel
- 3" stiles and rails
- Soft Close hinges

Drawers

- 3/4" thick 5-piece solid drawer head
- Undermount, Full Extension Soft Close guides
- Pulls required



SUMMERFIELD II

Maple and Cherry

- 3/4" thick solid door frame
- Full overlay
- Mortise and tenon door with flat veneer center panel
- 3" stiles and rails
- Soft Close hinges

Drawers

- 3/4" thick slab solid drawer head
- Undermount, Full Extension Soft Close guides
- Pulls required



JEFFERSON I

Maple and Cherry

- 3/4" thick solid door frame
- Full overlay
- Mortise and tenon door with flat veneer center panel
- 3" stiles and rails
- Soft Close hinges

Drawers

- 3/4" thick 5-piece veneer flat panel drawer head
- Undermount, Full Extension Soft Close guides
- Pulls required

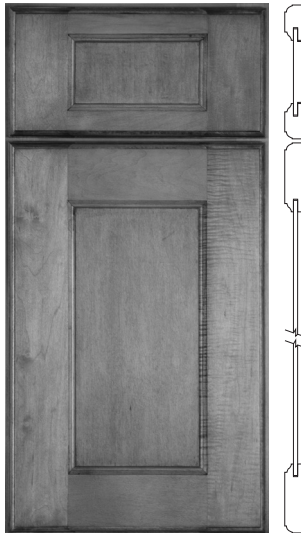

JEFFERSON II

Maple and Cherry

- 3/4" thick solid door frame
- Full overlay
- Mortise and tenon door with flat veneer center panel
- 3" stiles and rails
- Soft Close hinges

Drawers

- 3/4" thick solid front
- Undermount, Full Extension Soft Close guides
- Pulls required

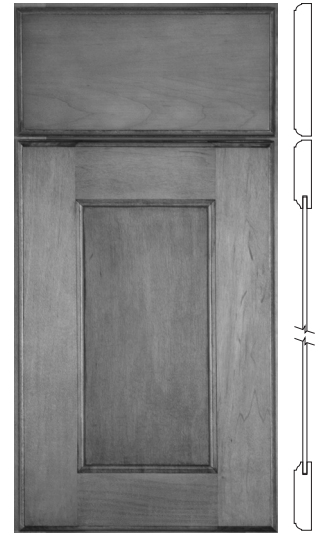

* De-selection of wood dovetail drawer with Full Extension, Soft Close feature available

* See page 0.23 for additional specifications for painted product

CABINET REFERENCES—Full Overlay

ARDMORE II

- Maple and Cherry
- 3/4" thick solid door frame
 - Full overlay
 - Mortise and tenon door with veneer raised center panel
 - 3" stiles and rails
 - Soft Close hinges

Drawers

- 3/4" thick solid front
- Undermount, Full Extension Soft Close guides
- Pulls required

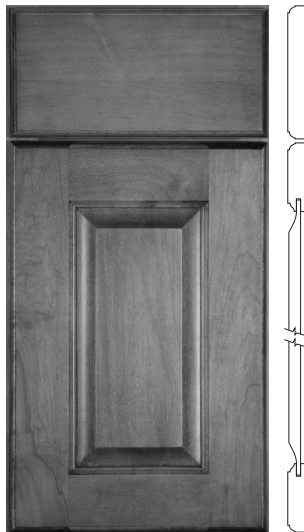

*Drawer Bases and Glass Door Cabinets will read Jefferson

ARDMORE III

- Maple and Cherry
- 3/4" thick solid door frame
 - Full overlay
 - Mortise and tenon door with veneer raised center panel
 - 3" stiles and rails
 - Soft Close hinges

Drawers

- 3/4" thick 5-piece veneer raised panel drawer head
- Undermount, Full Extension Soft Close guides
- Pulls required

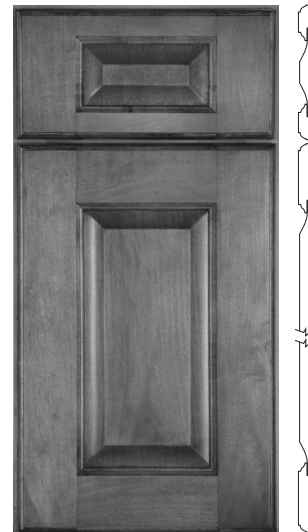

*Glass Door Cabinets will read Jefferson

WENTWORTH I

- Maple and Cherry
- 3/4" thick solid door frame
 - Full overlay
 - Mitered, soft-pillow profile door with flat veneer center panel
 - 3" stiles and rails
 - Soft Close hinges

Drawers

- 3/4" thick 5-piece veneer flat panel drawer head
- Undermount, Full Extension Soft Close guides
- Pulls required

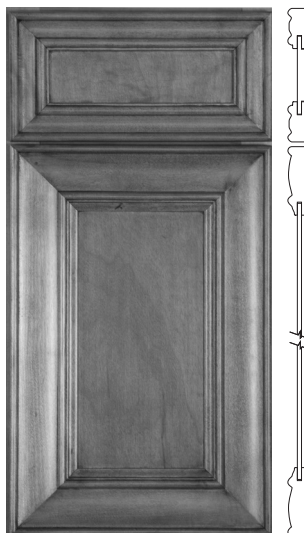

*Not available in Mullion

TRENTON I

- Maple and Cherry
- 3/4" thick solid door frame
 - Full overlay
 - Mitered, soft-pillow profile door with veneer raised center panel
 - 3" stiles and rails
 - Soft Close hinges

Drawers

- 3/4" thick 5-piece veneer flat panel drawer head
- Undermount, Full Extension Soft Close guides
- Pulls required

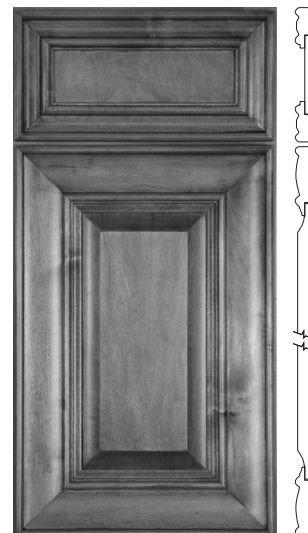

*Not available in Mullion

*Drawer Bases and Glass Door Cabinets will read Wentworth

* De-selection of wood dovetail drawer with Full Extension, Soft Close feature available

* See page 0.23 for additional specifications for painted product

CABINET REFERENCES—Full Overlay

TRENTON III

Maple and Cherry

- 3/4" thick solid door frame
- Full overlay
- Mitered, soft-pillow profile door with veneer raised center panel
- 3" stiles and rails
- Soft Close hinges

Drawers

- 3/4" thick 5-piece veneer raised panel drawer head
- Undermount, Full Extension Soft Close guides
- Pulls required

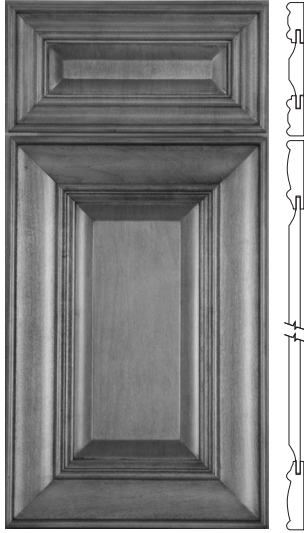

*Not available in Mullion

*Glass Door Cabinets will read Wentworth

ARCADIA

Maple and Cherry

- 3/4" thick solid door frame
- Full overlay
- Mortise and tenon door with flat veneer center panel and applied inset molding
- 3" stiles and rails
- Soft Close hinges

Drawers

- 3/4" thick 5-piece drawer head with applied inset molding
- Undermount, Full Extension Soft Close guides
- Pulls required



*Not available in Mullion

NORTHBROOK

Maple and Cherry

- 3/4" thick solid door frame
- Full overlay
- Mortise and tenon door with flat veneer center panel and applied overlay molding
- 3" stiles and rails
- Soft Close hinges

Drawers

- 3/4" thick 5-piece drawer head with applied overlay molding
- Undermount, Full Extension Soft Close guides
- Pulls required

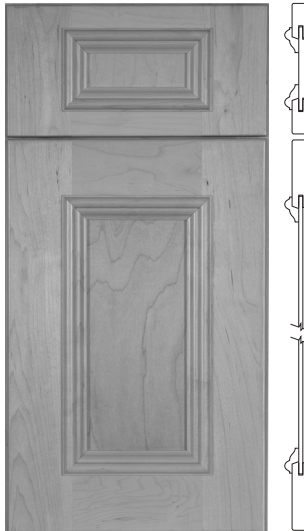

*Not available in Mullion

* De-selection of wood dovetail drawer with Full Extension, Soft Close feature available

* See page 0.23 for additional specifications for painted product

SLAB AND 5 PIECE DRAWER HEADS

Detailed below is what you can expect when ordering Drawer Bases (DB, DBP, VB, etc)

5 Piece Drawer Heads

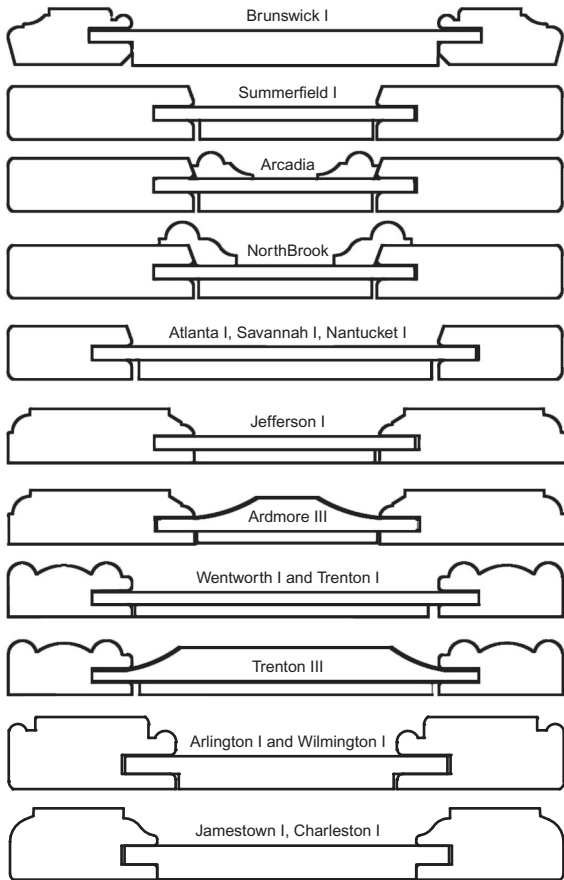

Slab Drawer Heads



* Upgrade drawer option available: wood dovetail drawer with Full Extension, Soft Close feature
 * See page 0.23 for additional specifications for painted product

GLASS AND MULLION PROFILES

Glass-Profile

Suited for Cambridge, Florence and Arch Florence.

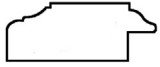

Glass-Profile

Suited for Parkwood, Arch Parkwood, Belwood and Arch Belwood.

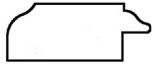

Glass-Profile

Suited for Brunswick.

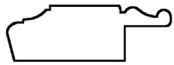

Glass-Profile

Suited for Jefferson and Ardmore.

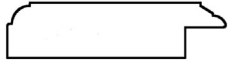

Glass-Profile

Suited for Summerfield.

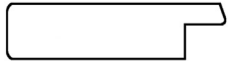

Glass-Profile

Suited for Wentworth and Trenton.



Glass-Profile

Suited for Atlanta, Savannah and Nantucket.

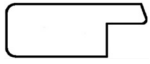

Glass-Profile

Suited for Wilmington and Arlington.



Glass-Profile

Suited for Jamestown and Charleston.

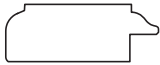

Glass-Profile

Suited for NorthBrook.



Glass-Profile

Suited for Arcadia.



Mullion-Profile

Suited for Florence and Cambridge.

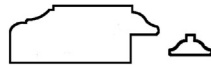

Mullion-Profile

Suited for Parkwood and Belwood.

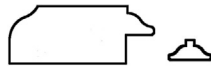

Mullion-Profile

Suited for Arch Florence.

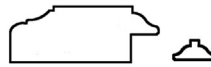

Mullion-Profile

Suited for Arch Parkwood and Arch Belwood.

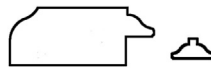

Mullion-Profile

Suited for Fairmont.



Mullion-Profile

Suited for Savannah and Nantucket.

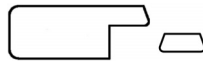

Mullion-Profile

Suited for Jamestown and Charleston.

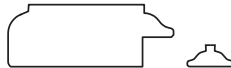

Mullion-Profile

Suited for Summerfield.

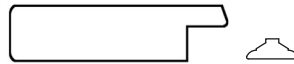

Mullion-Profile

Suited for Jefferson and Ardmore.

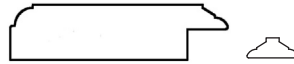

SPECIES AND FINISH AVAILABILITY CHART

													<i>Paints</i>					
			Autumn	Café	Cordovan	Espresso	Graphite	Natural	Sienna	Tuscany	Wheat	Medium	White	Onyx	Alpine	Greystone	Ivory	Linen
* Glaze Available			*	*	*	*	*	*	*	*	*				*	*	*	*
Door Style	Overlay	Wood Species																
Belwood	Standard	Oak						≠					≠					
Arch Belwood	Standard	Oak						≠					≠					
Cambridge Oak	Standard	Oak	○	○		○		○	○	○								
Cambridge Birch	Standard	Birch	○	○	○	○			○	○	○				○	○	○	
Cambridge Maple	Standard	Maple	●	●	●	●	●	●	●	●	●			●	●	●	●	●
Cambridge Cherry	Standard	Cherry	●	●	●	●	●		●	●	●							
Atlanta I Birch	Standard	Birch	○	○	○	○				○					○	○	○	
Atlanta II Birch	Standard	Birch	○	○	○	○				○					○	○	○	
Atlanta I Maple	Standard	Maple	●	●	●	●	●	●	●	●	●			●	●	●	●	●
Atlanta II Maple	Standard	Maple	●	●	●	●	●	●	●	●	●			●	●	●	●	●
Atlanta I Cherry	Standard	Cherry	●	●	●	●	●		●	●	●							
Atlanta II Cherry	Standard	Cherry	●	●	●	●	●		●	●	●							
Brunswick I Birch	Standard	Birch	○	○	○	○				○					○	○	○	
Brunswick II Birch	Standard	Birch	○	○	○	○				○					○	○	○	
Brunswick I Maple	Standard	Maple	●	●	●	●	●	●	●	●	●			●	●	●	●	●
Brunswick II Maple	Standard	Maple	●	●	●	●	●	●	●	●	●			●	●	●	●	●
Brunswick I Cherry	Standard	Cherry	●	●	●	●	●		●	●	●							
Brunswick II Cherry	Standard	Cherry	●	●	●	●	●		●	●	●							
Parkwood	Standard	Oak						≠					≠					
Arch Parkwood	Standard	Oak						≠					≠					
Florence Birch	Standard	Birch	○	○	○	○			○	○	○				○	○	○	
Florence Maple	Standard	Maple	●	●	●	●	●	●	●	●	●			●	●	●	●	●
Arch Florence Maple	Standard	Maple	●	●	●	●	●	●	●	●	●			●	●	●	●	●
Florence Cherry	Standard	Cherry	●	●	●	●	●		●	●	●							
Arch Florence Cherry	Standard	Cherry	●	●	●	●	●		●	●	●							
Fairmont	Standard	Thermofoil											≠					

- Available:
 ≠ No Glaze
- Glaze Type:
 ● Hand Wiped
 ○ Accent
- Glazes Available:
 Slate **NEW**
 Alabaster
 Caramel
 Chocolate
 Mocha (Paints Only)

SPECIES AND FINISH AVAILABILITY CHART

																<i>Paints</i>		
			Autumn	Café	Cordovan	Espresso	Graphite	Natural	Sienna	Tuscany	Wheat	Medium	White	Onyx	Alpine	Greystone	Ivory	Linen
* Glaze Available			*	*	*	*	*	*	*	*	*				*	*	*	*
Door Style	Overlay	Wood Species																
Savannah I & II	Full	Maple	●	●	●	●	●	●	●	●	●			●	●	●	●	●
Savannah I & II	Full	Cherry	●	●	●	●	●		●	●	●							
Jamestown I & II	Full	Maple	●	●	●	●	●	●	●	●	●			●	●	●	●	●
Jamestown I & II	Full	Cherry	●	●	●	●	●		●	●	●							
Wilmington I	Full	Maple	●	●	●	●	●	●	●	●	●			●	●	●	●	●
Wilmington I	Full	Cherry	●	●	●	●	●		●	●	●							
Charleston I & II	Full	Maple	●	●	●	●	●	●	●	●	●			●	●	●	●	●
Charleston I & II	Full	Cherry	●	●	●	●	●		●	●	●							
Arlington I	Full	Maple	●	●	●	●	●	●	●	●	●			●	●	●	●	●
Arlington I	Full	Cherry	●	●	●	●	●		●	●	●							
Apex	Full	Maple	●	●	●	●	●	●	●	●	●			●	●	●	●	●
Apex	Full	Cherry	●	●	●	●	●		●	●	●							
Nantucket I & II	Full	Maple	●	●	●	●	●	●	●	●	●			●	●	●	●	●
Nantucket I & II	Full	Cherry	●	●	●	●	●		●	●	●							
Summerfield I & II	Full	Maple	●	●	●	●	●	●	●	●	●			●	●	●	●	●
Summerfield I & II	Full	Cherry	●	●	●	●	●		●	●	●							
Jefferson I & II	Full	Maple	●	●	●	●	●	●	●	●	●			●	●	●	●	●
Jefferson I & II	Full	Cherry	●	●	●	●	●		●	●	●							
Ardmore II & III	Full	Maple	●	●	●	●	●	●	●	●	●			●	●	●	●	●
Ardmore II & III	Full	Cherry	●	●	●	●	●		●	●	●							
Wentworth I	Full	Maple	●	●	●	●	●	●	●	●	●			●	●	●	●	●
Wentworth I	Full	Cherry	●	●	●	●	●		●	●	●							
Trenton I & III	Full	Maple	●	●	●	●	●	●	●	●	●			●	●	●	●	●
Trenton I & III	Full	Cherry	●	●	●	●	●		●	●	●							
NorthBrook	Full	Maple	●	●	●	●	●	●	●	●	●			●	●	●	●	●
NorthBrook	Full	Cherry	●	●	●	●	●		●	●	●							
Arcadia	Full	Maple	●	●	●	●	●	●	●	●	●			●	●	●	●	●
Arcadia	Full	Cherry	●	●	●	●	●		●	●	●							

Available:
 ≠ No Glaze

Glaze Type:
 ● Hand Wiped
 ○ Accent

Glazes Available:
 Slate **NEW**
 Alabaster
 Caramel
 Chocolate
 Mocha (Paints Only)

Marsh Furniture Company offers both solid hardwoods and hardwood veneers in our cabinetry. These natural materials have inherent characteristics such as varying grain pattern, small mineral streaks, knots, and slight color variations. Because of this, our quality standards establish tolerance ranges for matching the wood.

These variations are what create the unique natural beauty of each piece. Additionally, exposure to sunlight, smoke, and other chemical agents can cause wood colors to change over time. You are urged to make final selection of species and finish from a full size door sample.

Cherry is a moderately hard wood, heavy and strong. It is generally a straight grained, uniformly textured wood characterized by its red undertones. Given that, it may range in color from a light to dark reddish brown heartwood with tones from greenish to white sapwood. There is also a natural occurrence of small knots, pitch pockets or wormholes in the surface of the wood. Cherry is well known for its response to artificial and natural light sources, developing a rich and lustrous patina in the colors noted above. These variations are often quite visible with natural or light finishes while appearing less on darker stains, shielding the wood from various light sources.

Maple is a hard and dense wood with a close grain that is relatively subtle in appearance. The grain pattern may vary from a tight vertical pattern to a wild arch-shape. The color range runs from white to yellow and brown. Marsh is very selective in this color range, ensuring the brown portion to have a faint brown tint. Inherently, there are fine honey-colored mineral and sugar streaks. Maple will react to both natural and artificial light sources, taking on a slightly subdued patina. When a light finish is applied, these variations are visible and should not be considered defects.

Oak is an extremely hard wood with an open grain pattern. The pattern may vary from a tight to wide pattern with a coarse texture. In oak's natural state, colors may range from brownish with a red tinge to a light yellow. When a light finish is applied, these variations are visible and should not be considered a defect.

Birch is a medium-hard wood with plain and closed grain. The grain is often characterized as a curly or wavy pattern. It is predominantly a light yellow wood that takes stain very well. When a light finish is applied these variations may be visible and should not be considered a defect. When a dark stain is applied the wavy and curly grain absorbs stain and reflects light in such a manner as to enhance the natural characteristics of the species and should not be considered a defect.

Thermofoil is Medium Density Fiberboard (MDF) covered with a durable thermofoil laminate. The maple wood frame is painted with a white paint to closely match the laminate. You may notice some small seams in the paint at the joints of the cabinetry face frame due to expansion and contraction of the wood. This will not affect the integrity of the cabinet or the finish.

Painted Wood differs from standard finishes. Wood products expand and contract due to changes in climatic conditions. Some of the characteristics that are common and acceptable aspects of painted wood include finish breaks, slight recesses, and seam lines at stile, rail, and panel joints. Joint separation may be more apparent on mitered doors; therefore, opaque finishes are not recommended for use in environments of high humidity. Since seam lines and variations are normal characteristics of opaque finishes, they will not be considered reason for product replacement.

* Marsh may substitute select hardwoods for a more consistent painted product *

Painted Alpine in standard cabinet construction will be a white laminated material, both interior and exterior. However, when Plywood is chosen, the interior and exterior components will be clear-coated natural birch veneer unless Finished Interior is chosen. In order for ends to be white on Plywood, Overlay Ends will need to be ordered.

You may be required to sign a FINISH WAIVER FORM when ordering a painted product. Neither Marsh Furniture nor your Marsh dealer can be responsible for these conditions.

CABINET SPECIFICATIONS

A Face Frames

- Constructed of 3/4" kiln-dried select woods grooved to accept the cabinet box
- Joints are mortise and 3/8" tenon construction, glued and secured with steel fasteners
- Base cabinet and the wall cabinet frames have 1-1/2" stiles and rails

B Doors

- Solid wood stiles and rails
- Wood veneer door panels
- Thermofoil Medium Density Fiberboard (MDF) door selections

C End Panels

- Constructed of 1/2" industrial grade particleboard laminated with exterior laminate to match finish; interior is natural maple laminate
- The white door styles are white laminate

Top and Bottom Panels

- Top and bottom panels are 1/2" industrial grade particleboard laminated
- White door styles are white laminate

Back Panels

- Back panels are 1/8" industrial grade medium density fiberboard (MDF) laminated on interior, captured between end panels
- White door styles are white laminated interior

↙ Hanger Rails

- Wall cabinet top and bottom hanger rails are 5/8" industrial grade Medium Density Fiberboard (MDF) secured behind the back panel, captured between end panels

D Shelves

- Shelves are constructed of 5/8" industrial grade particleboard laminated on both faces
- White door styles are white laminate
- The front edges of shelves have PVC edge-banding applied to match interior
- **Base shelves** are 5/8" thick adjustable and half-depth
- **Wall shelves** are 5/8" thick and adjustable in 2.5" increments

E Hinges

- 6-way fully concealed 108° self-closing cup hinges allow easy height (vertical), side (horizontal) and depth (in/out) adjustment
- Soft Close hinges are standard on "Full Overlay Lines"

F Cabinet Interior

- The standard cabinet interior is a laminate with a natural wood grain print
- A white laminate interior will be used for thermofoil and painted door styles in white
- **Finished Interior Option (FI)** — On wall, base and tall cabinets up to 24" deep, the "FI" option can be selected
- The cabinet interior will be a grain print laminate that matches the finish color
- FI option on glazed cabinets will not be glazed but will match the finish color
- Shelves in cabinets with the FI option will be PVC edge banded to match

G Drawers

- Drawers feature 5/8" particleboard drawer box construction with side-mount, self aligning, epoxy-coated guides and attached to drawer with screws
- Drawer bottoms are 7/32" laminated industrial grade particleboard
- The drawer bottom is fully captured into a groove, positioned 1/2" up from the bottom edge of sides, front, and back
- Drawer guides are certified up to 75 lb.

Upgrade Option (Standard feature on "Full Overlay Lines"):

- 5/8" Wood dovetail drawer box with Full Extension undermount Soft Close guide system (FX)
- Drawer sides, front and back, are constructed of 5/8" solid wood featuring dovetail construction
- Wood drawer bottoms are 1/4" plywood
- Drawer guides are certified up to 75 lbs.

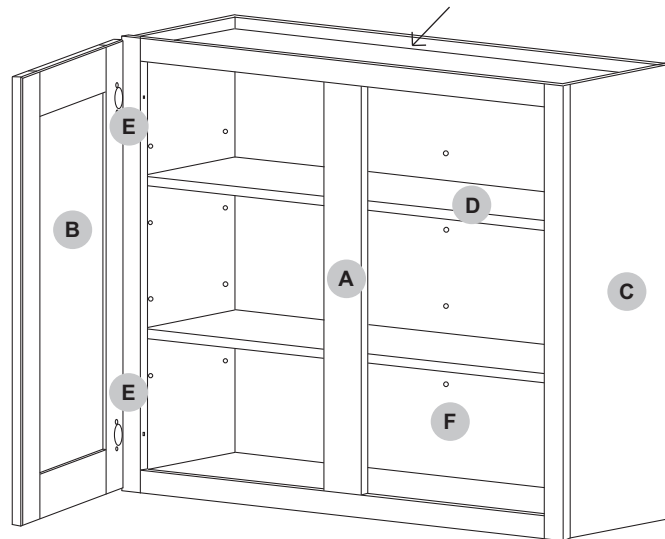

H Base Corner Braces

- Rigid plastic secured with steel fasteners
- Braces are pre-drilled to anchor the countertops

I Toe Kicks

- The toe kick is inset into the cabinet box 3-1/2" and is 4-1/2" high
- Toe kicks are 1/2" unfinished industrial grade particleboard
- To finish the toe kick space, a TK or TP overlay is required (page 5.17)

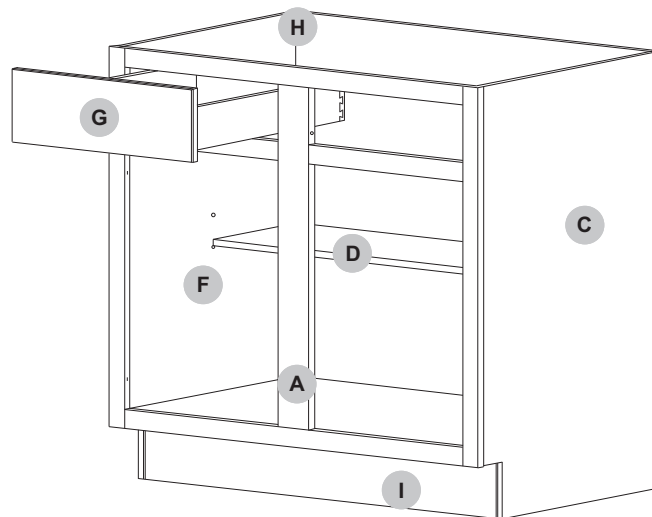

— Options available are listed under each cabinet

CASE OPTIONS AND SPECIFICATIONS FOR PLYWOOD CABINETS

Plywood Construction (PC)

Available on Wall, Base/Vanity, Tall

- ◆ Toe kick is 1/2" plywood
- ◆ 1/2" plywood sides
- ◆ 7/32" birch veneer backs
- ◆ 3/4" plywood shelves for Walls
- ◆ 5/8" plywood shelves for Bases
- ◆ Interior will be clear-coated, natural birch veneer
- ◆ Overlay Ends (OE) can be ordered if a flushed end is desired. See page 5.02.
- ◆ Finished Ends need to be ordered to match the cabinet finish where ends are exposed using Oak/Maple/Cherry veneer.

MODIFICATIONS TABLE

Option	Code
Premium Species	Cherry
Premium Finishes	Maple
	Birch
Premium Glazes	Slate NEW
	Alabaster
	Caramel
	Chocolate
	Mocha (Paint only)
Full Extension Upgrades (standard overlay only)	<u>EX</u> (Full Extension wood drawer)
Full Extension De-selections (full overlay only)	<u>EX</u> (Full Extension wood drawer)
Reduce Depth of Wall (3" increments, with 6" being minimum depth)	RD
Reduce Depth of Base (3" increments, with 6" being minimum depth) Excludes VL1816	RD
Reduce Depth of Tall (3" increments, with 6" being minimum depth)	RD
Increase Depth of Wall (3" increments, with 24" being maximum depth)	AD
Full Depth Shelf added to Base Cabinet Excluding Sink Bases	FDS
Fronts and Doors ONLY	WCF (Walls)
	BSF (Bases)
Bottom Drawers (inverted frame)	BD
Island Cabinets Not Shown	IB / IW
No Door / No Drawer Cabinet	ND / NDWR
Finished Interiors (White lines already match)	FI
No Door / No Drawer Cabinet WITH Finished Interior	NDFI
Factory Applied Overlay Ends	AE
Factory Applied Decorative Doors	OVD
Factory Installed Accessories	IA
Plywood Construction	PC
Plywood Finished Ends	FE
Handicap Cabinets	HTP
	SH
	HC
Modifications can NOT be made to angled cabinets (WEA, WEC, CAR, LSCB, EZCB) due to the nature of construction. Limited modifications are available on Microwave Cabinets, Oven Cabinets, Farm Sink Bases and Bookcases. For information or help on modifications, please contact our Customer Service Representatives.	

CABINET DIMENSIONS

*** not to scale

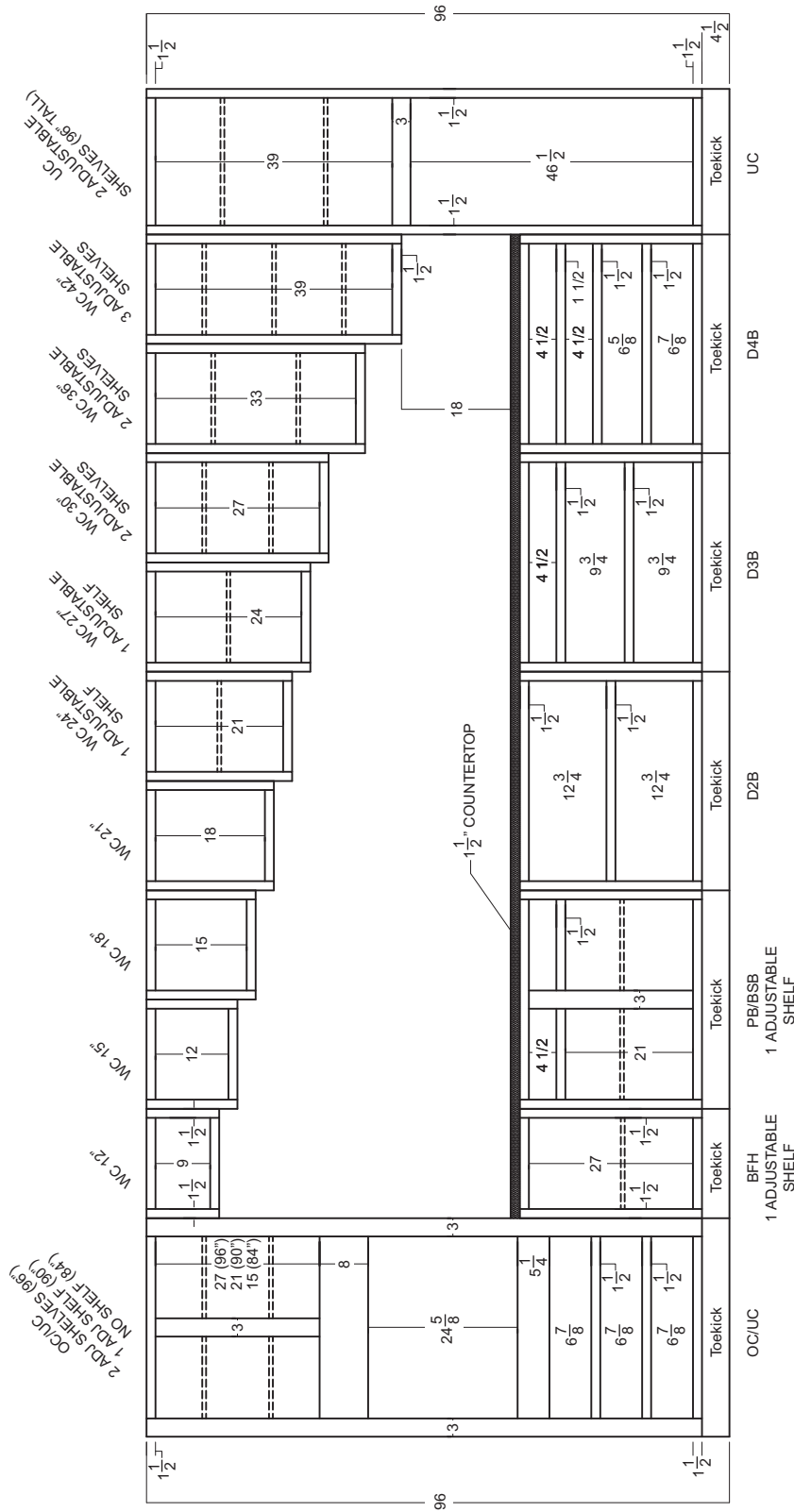

Inside measurements are for openings

CABINET DIMENSIONS - BASES

*** not to scale

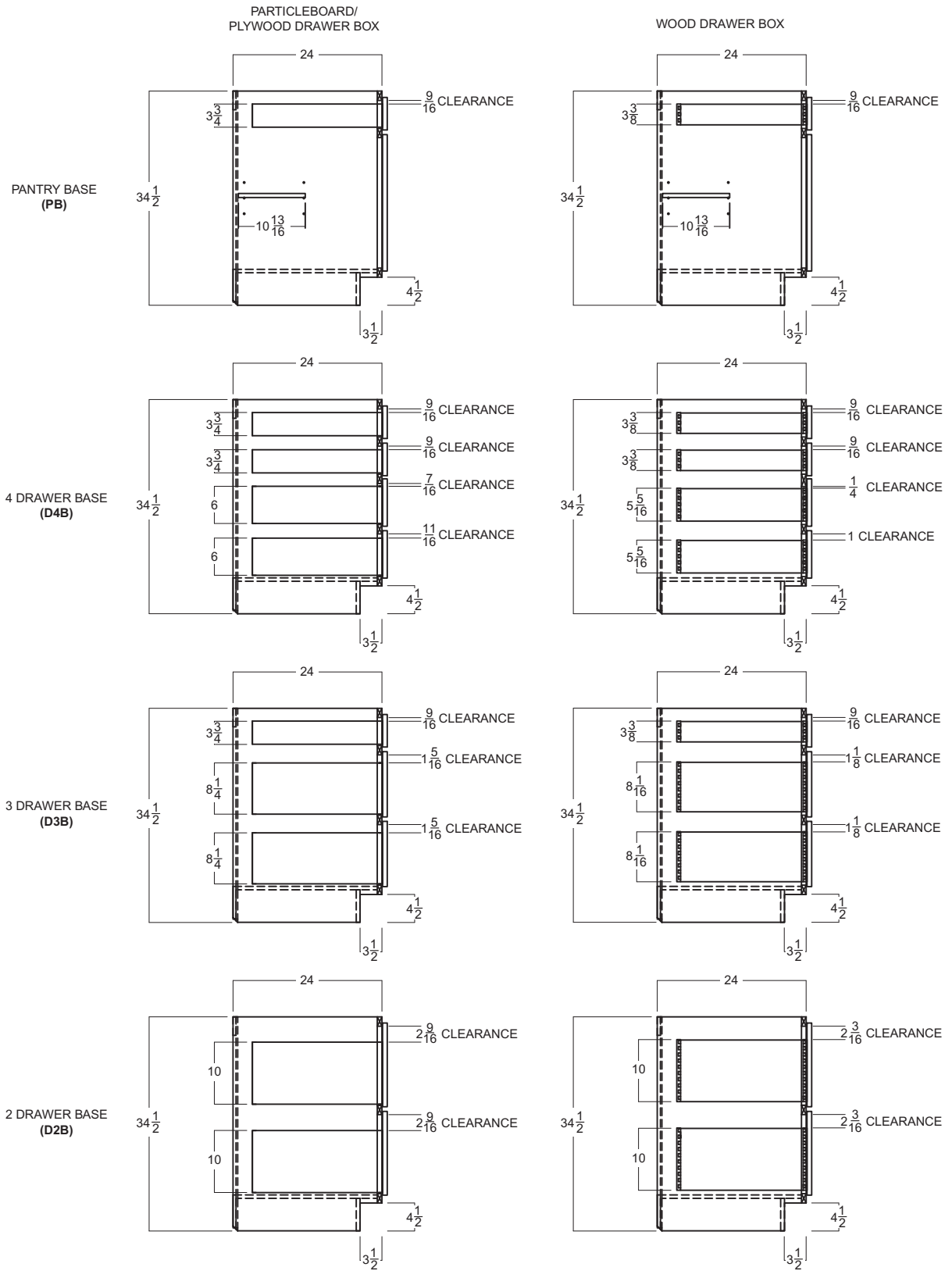

Inside measurements are for openings

CABINET DIMENSIONS - VANITIES

*** not to scale



Inside measurements are for openings

CABINET DIMENSIONS - VANITIES

*** not to scale

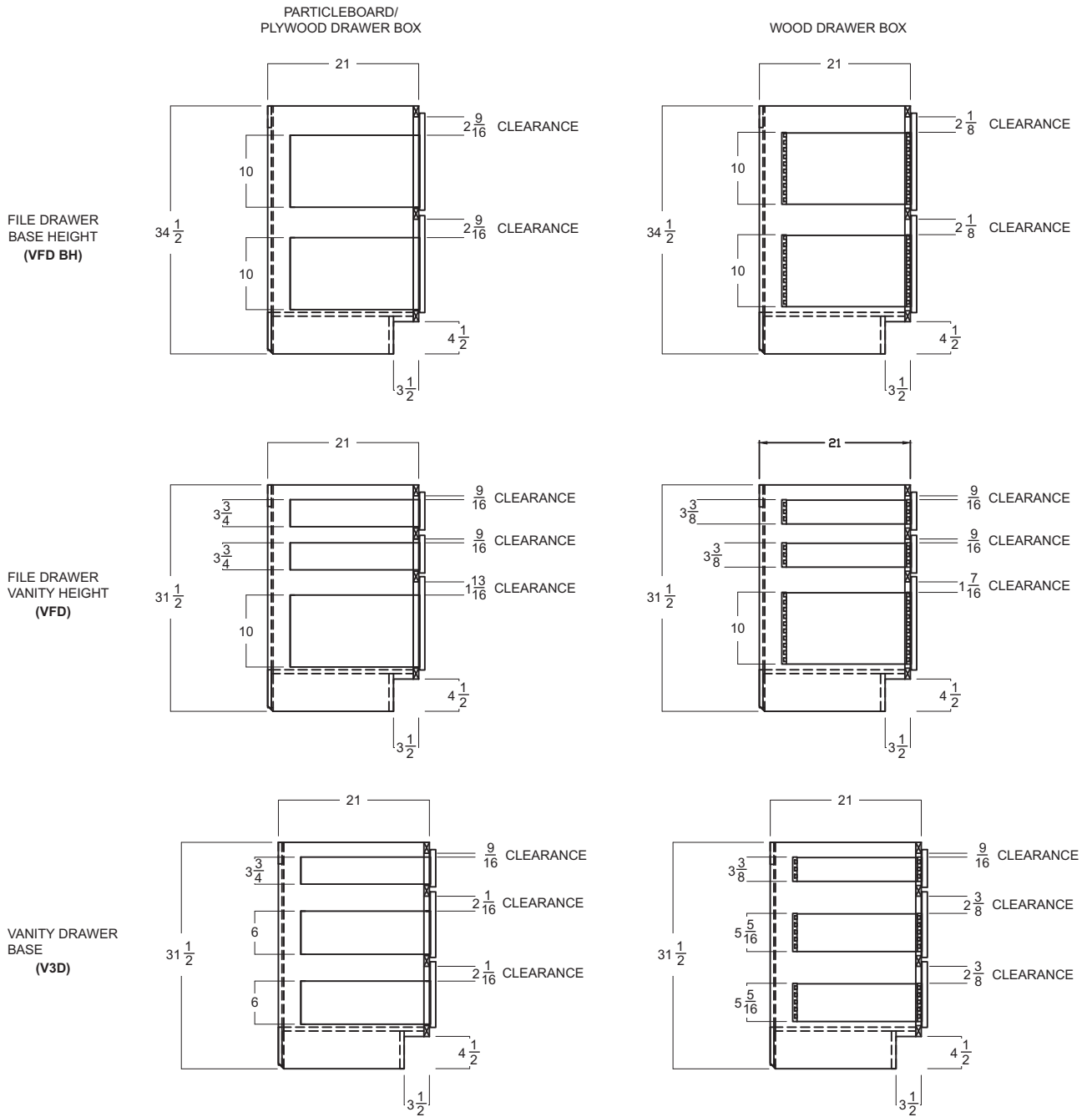

Inside measurements are for openings

CABINET DIMENSIONS - VANITIES

*** not to scale

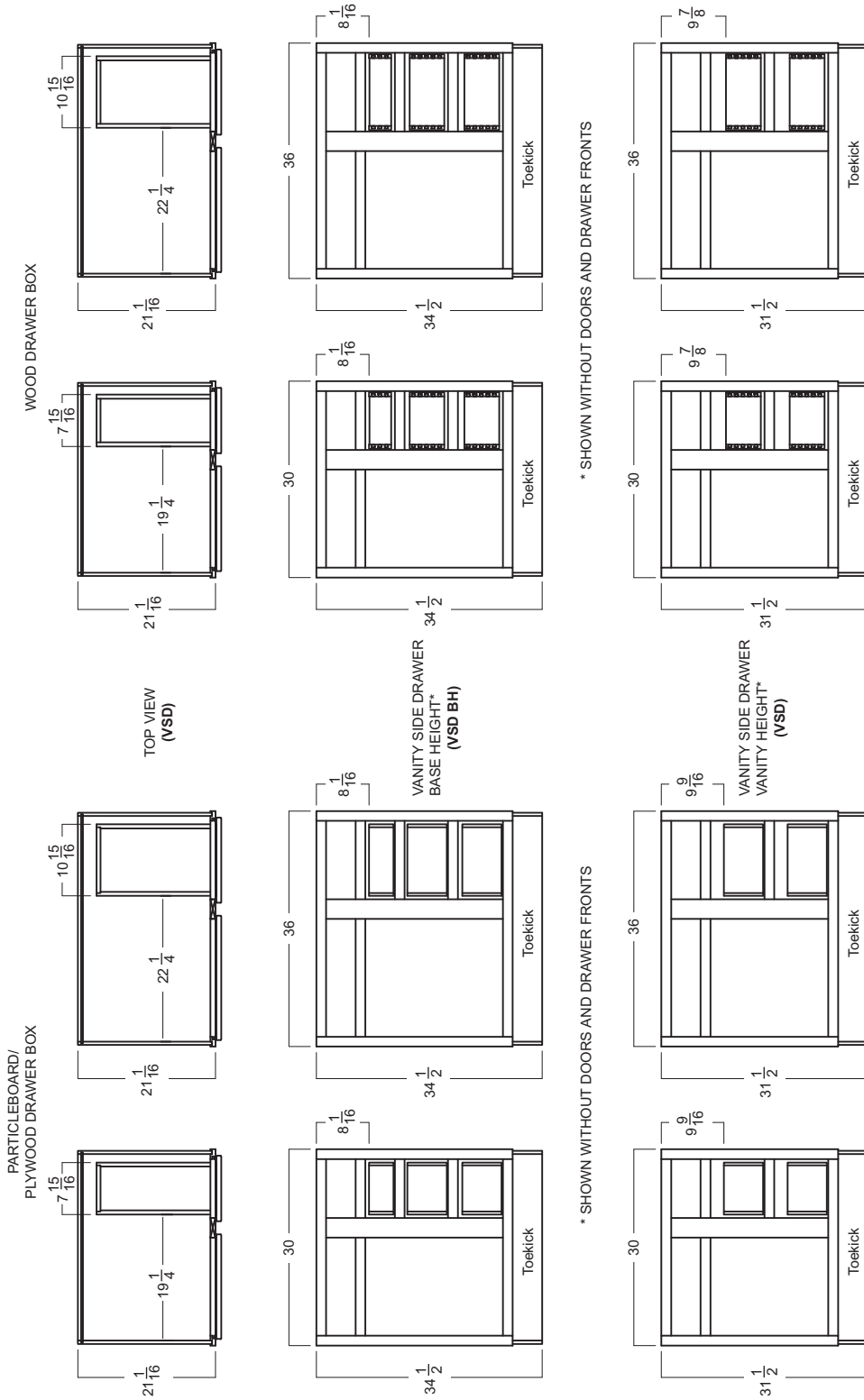

Inside measurements are for openings

CABINET DIMENSIONS - BLINDS

*** not to scale

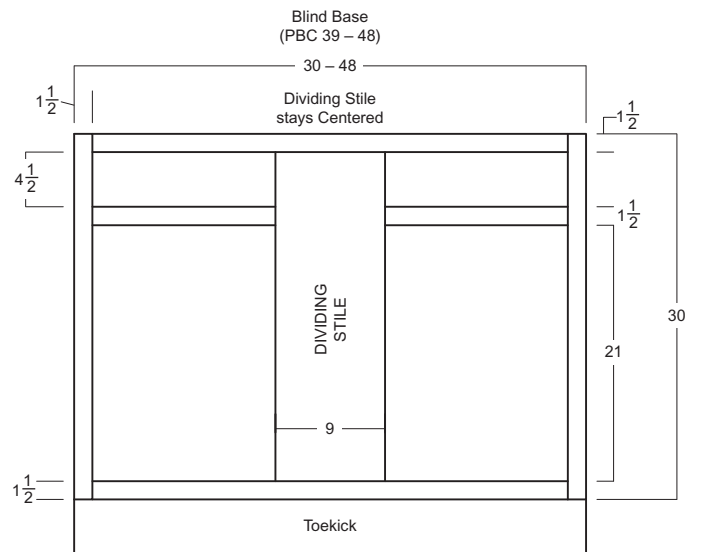
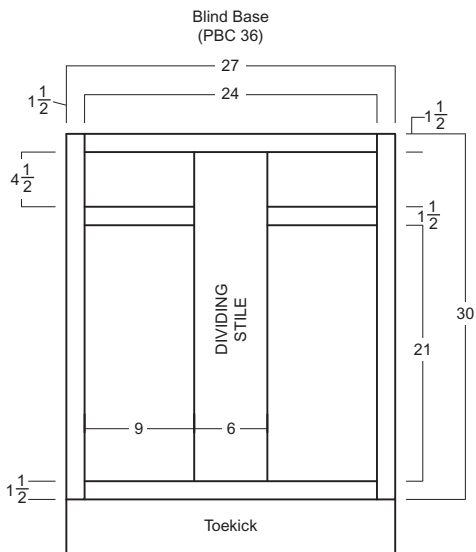
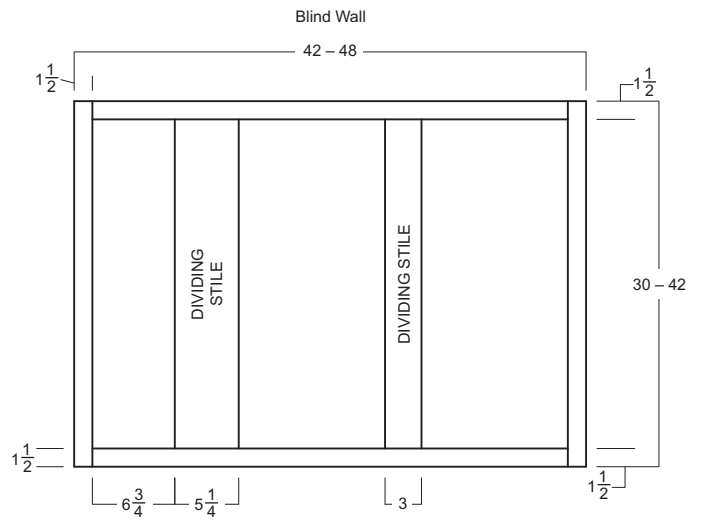
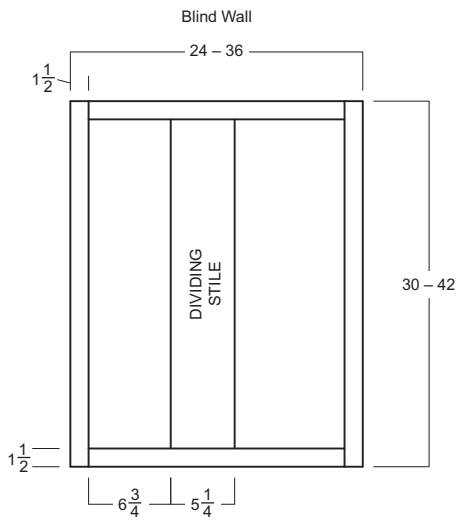

Inside measurements are for openings

CABINET DIMENSIONS - CORNER WALLS

*** not to scale

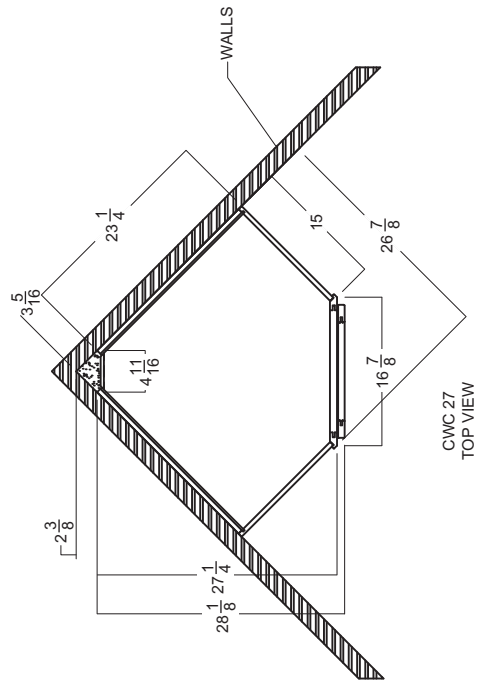
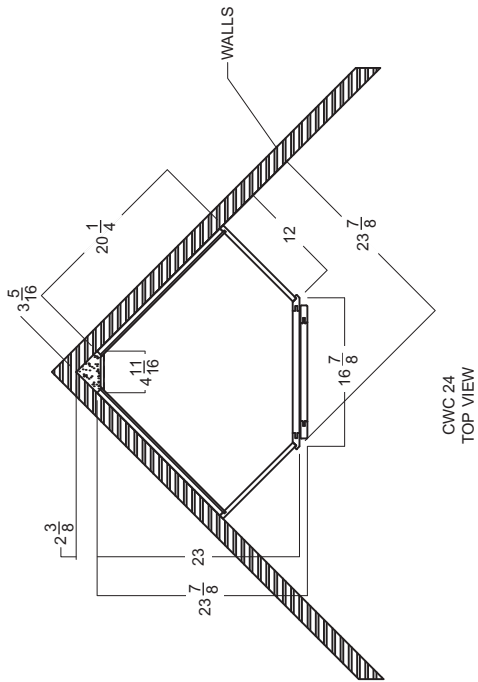
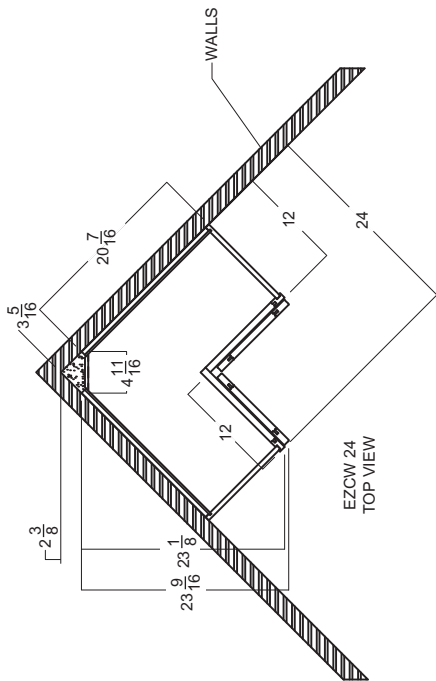

Inside measurements are for openings

CABINET DIMENSIONS - CORNER BASES

*** not to scale

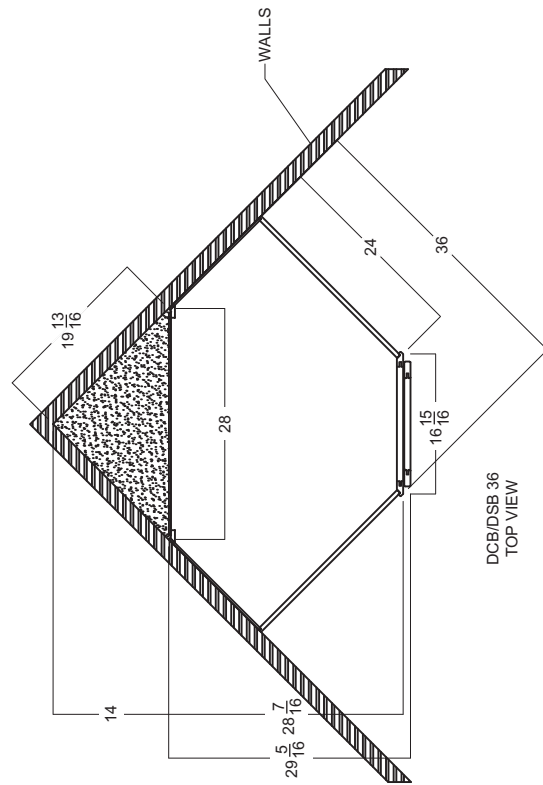
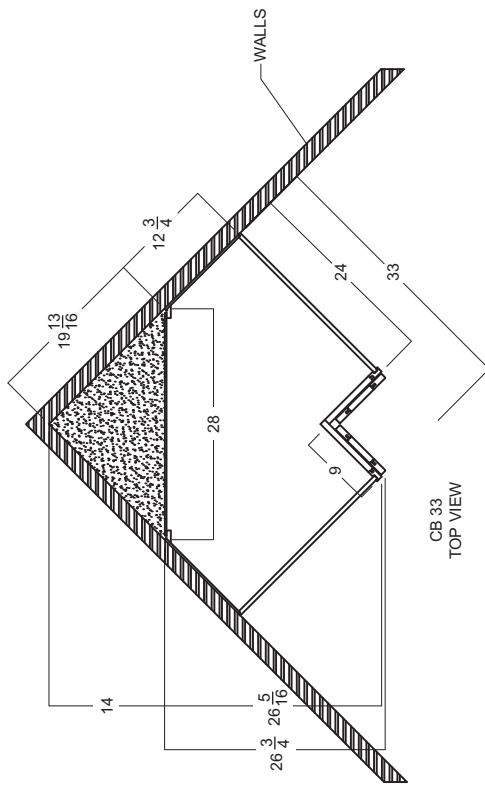
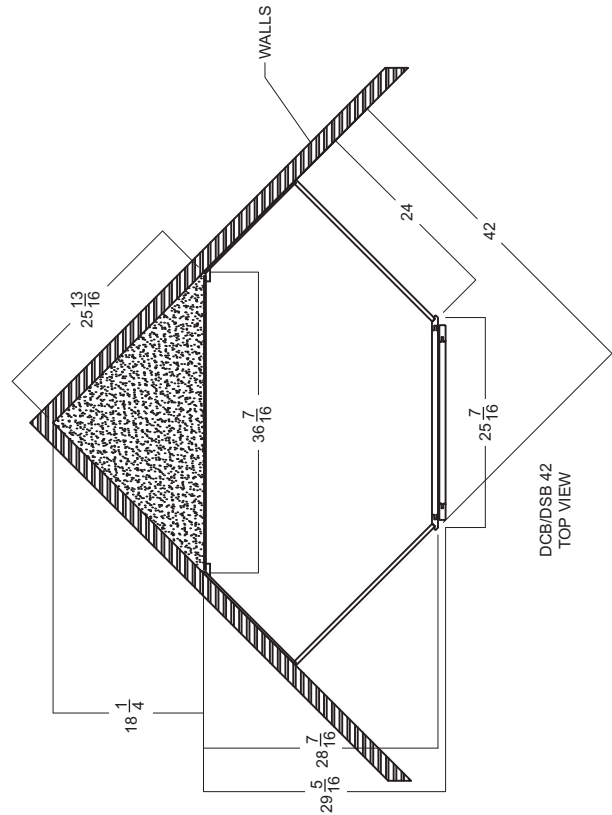
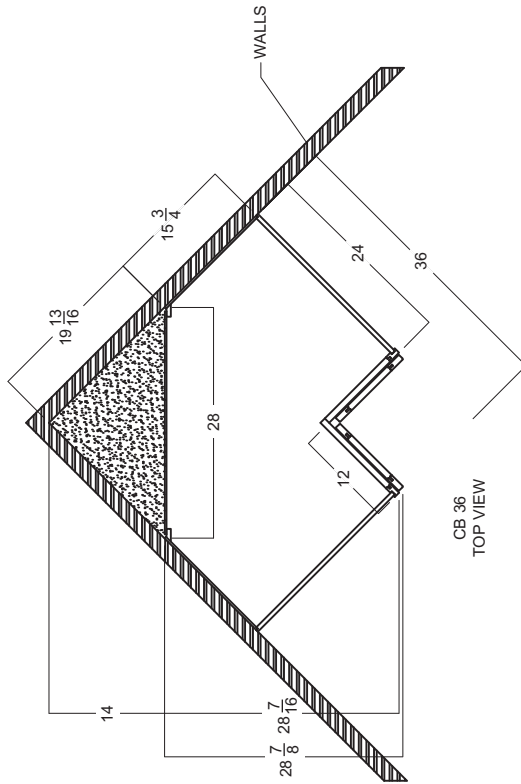

Inside measurements are for openings

CABINET DIMENSIONS - MISC

*** not to scale

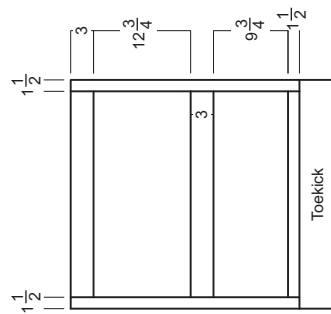
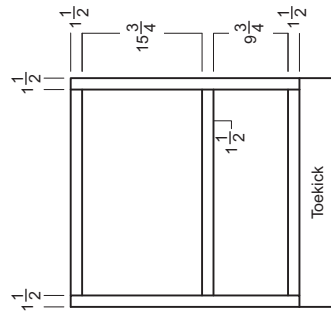
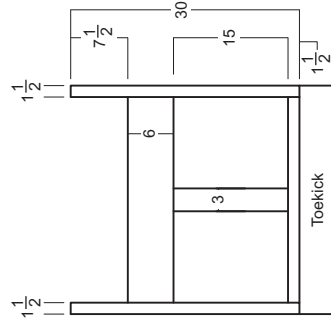
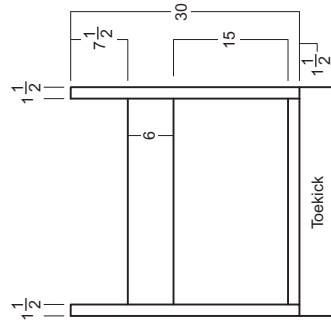
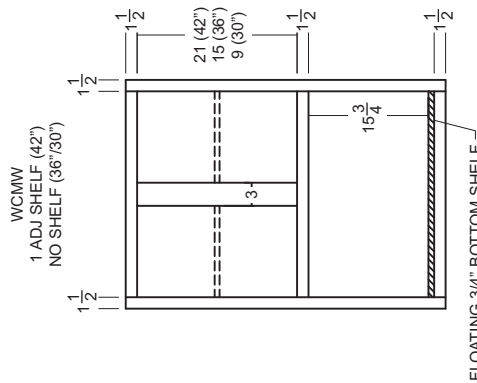
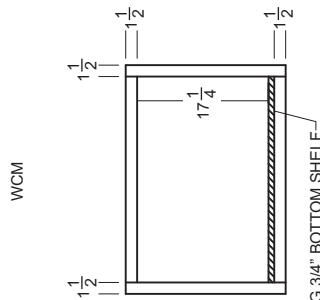
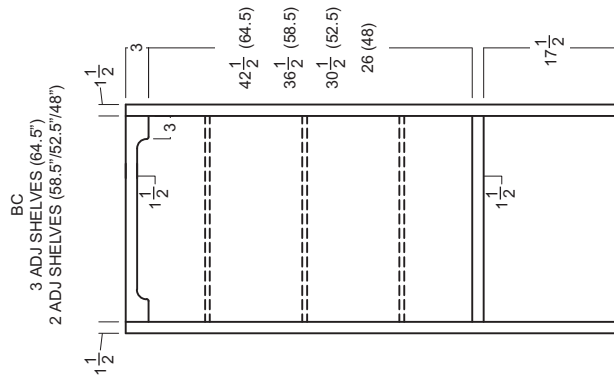
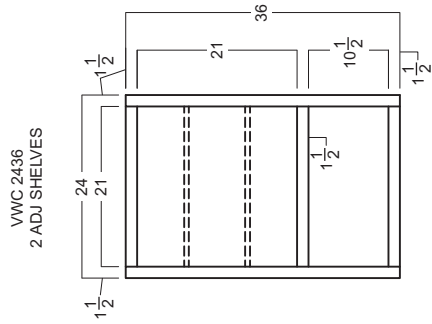

Inside measurements are for openings

CABINET DIMENSIONS - OVERLAY AND REVEALS

*** not to scale

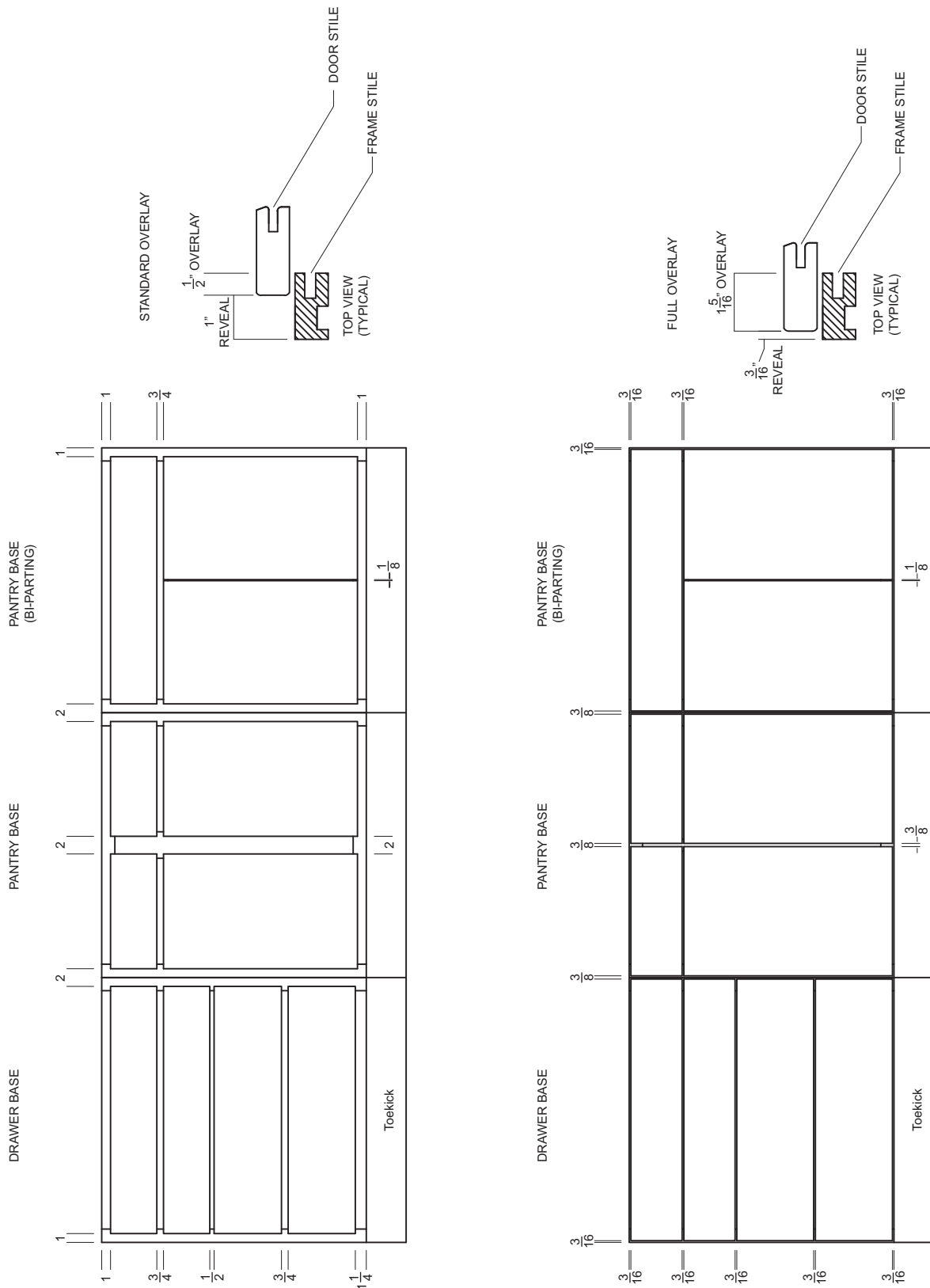

Inside measurements are for openings

ADA OPTIONS#

Americans with Disabilities Act
*3-week lead time

HTP = HIGH TOE PLATE
HC = HANDICAP
SH = SPECIAL HEIGHT

#Marsh does not imply ADA compliance; compliance is achieved through design and installation.

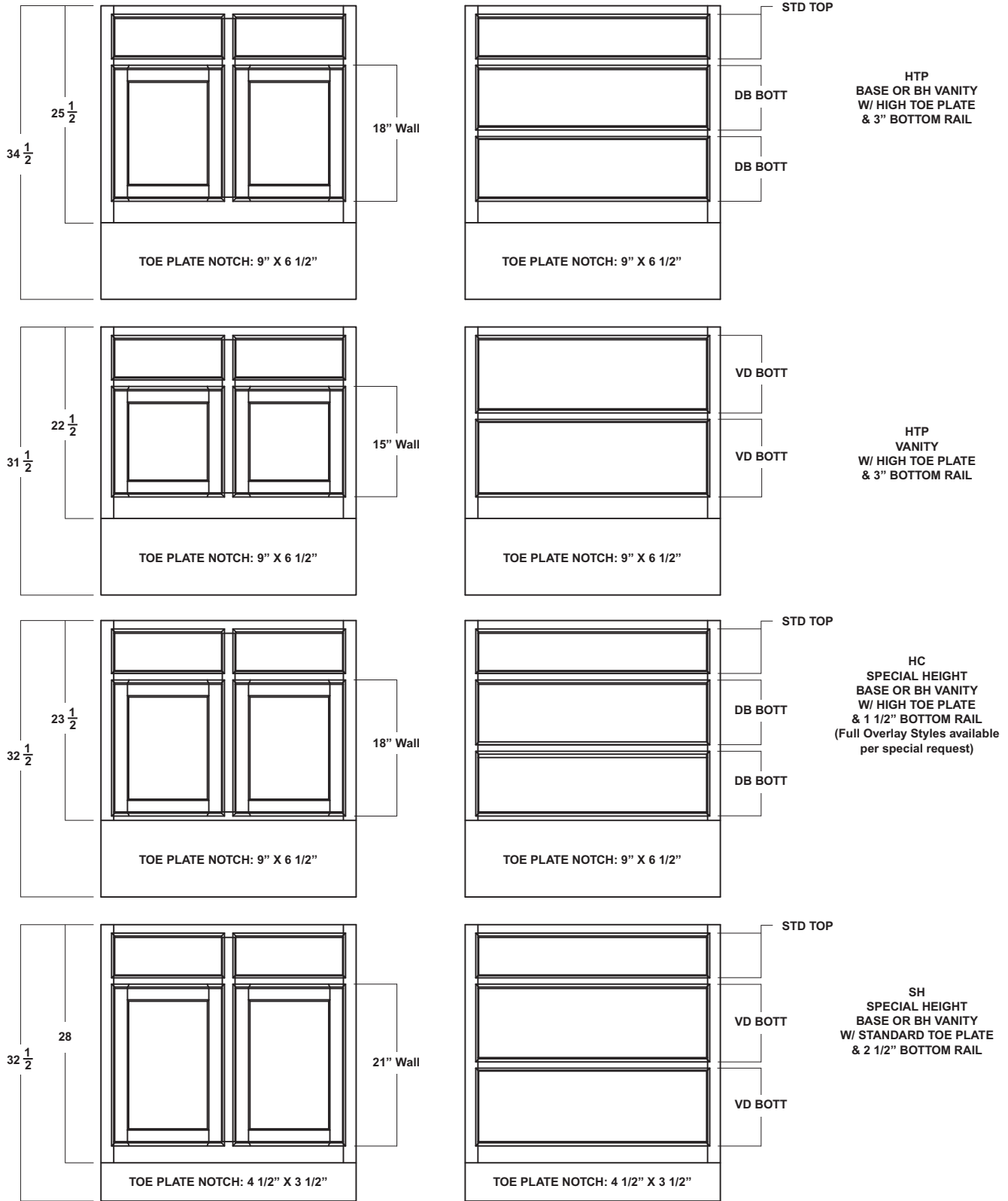

Hinges have a 165° opening on standard overlay lines.

Wall Cabinets

Construction Options and Modifications

PC - Plywood Construction

RD - Reduce Depth

AD - Added Depth

ND - No Doors

FI - Finished Interior

AE - Applied Overlay Ends

IA - Installed Accessories

How to read item code:

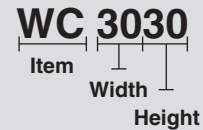

Option Chart Symbols

- Standard
- Ⓢ Available with an Upcharge
- ⚠ Available with Exceptions
- ⊗ Not Available

Reference Modifications Table on Page 0.27

Features:

- ◆ Cabinet interior is laminate with a natural maple grain pattern. White interior will be used on Fairmont and Alpine cabinets. Note, when ordering Fairmont and Alpine in Plywood, interior will be natural maple unless ordered with Finished Interior.
- ◆ Hinges are fully concealed 6-way adjustable.
- ◆ Hinging must be specified left or right for Arch door styles.
- ◆ Right-hand hinging standard on single door cabinets.
- ◆ Please refer to Cabinet References (pages 0.09-0.18) for decorative hardware requirements.
- ◆ Soft Close integrated hinge on Full Overlay lines.

Options:

Available options are noted beside each cabinet.

- ◆ Depth Change: A reduction in 3" increments with 6" being minimum depth allowable. Cabinets may be increased in 3" increments up to a maximum depth of 24".
- ◆ No Doors: Finished interior is not included standard in this option.
- ◆ Finished Interior: Glazed cabinets will not have a glazed interior.
- ◆ Applied Overlay Ends: Use an Overlay End to flush out an end. This is required when applying a decorative door.

Additional Notes on Glass and Mullion:

- ◆ Arcadia, NorthBrook, Brunswick, Apex, Wilmington, Arlington, Wentworth and Trenton are not available in Mullion Doors.
- ◆ Fairmont and Apex not available in Glass Doors.

- Standard
- Ⓢ Available with an Upcharge
- ⚠ Available with Exceptions
- ⊗ Not Available

Refer to pages 0.21-0.22 for Door and Finish Availability Chart

OPTIONS

- RD Reduce Depth
- AE Applied Overlay Ends
- AD Add Depth
- IA Installed Accessories
- FI Finished Interior
- BD Bottom Drawers
- ND No Doors/No Drawers
- AA ADA Adaptable

12" Deep Wall Cabinets

12" HIGH

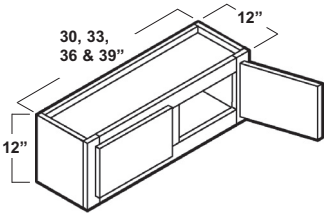

- WC3012
- WC3312
- WC3612
- WC3912

RD	AD	FI	ND	AE	IA	BD	AA
Ⓢ	Ⓢ	Ⓢ	Ⓢ	Ⓢ	⊗	⊗	⊗

Two doors, no shelves

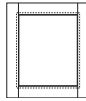

- WC3012GL
- WC3312GL
- WC3612GL
- WC3912GL



- WC3012MD
- WC3312MD
- WC3612MD
- WC3912MD

12" HIGH, BI-PARTING

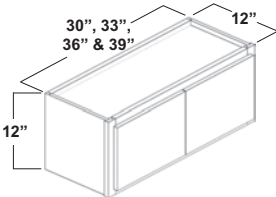

- WC3012BP
- WC3312BP
- WC3612BP
- WC3912BP

RD	AD	FI	ND	AE	IA	BD	AA
Ⓢ	Ⓢ	Ⓢ	Ⓢ	Ⓢ	⊗	⊗	⊗

Bi-Parting doors, no shelves
No center stile, 1/8" reveal between doors

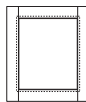

- WC3012BPGL
- WC3312BPGL
- WC3612BPGL
- WC3912BPGL



- WC3012BPMD
- WC3312BPMD
- WC3612BPMD
- WC3912BPMD

15" HIGH

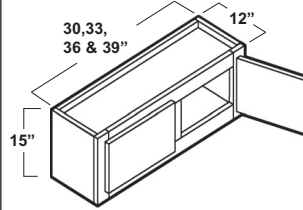

- WC3015
- WC3315
- WC3615
- WC3915

RD	AD	FI	ND	AE	IA	BD	AA
Ⓢ	Ⓢ	Ⓢ	Ⓢ	Ⓢ	⊗	⊗	⊗

Two doors, no shelves

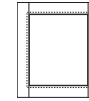

- WC3015GL
- WC3315GL
- WC3615GL
- WC3915GL



- WC3015MD
- WC3315MD
- WC3615MD
- WC3915MD

15" HIGH, BI-PARTING

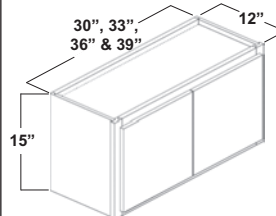

- WC3015BP
- WC3315BP
- WC3615BP
- WC3915BP

RD	AD	FI	ND	AE	IA	BD	AA
Ⓢ	Ⓢ	Ⓢ	Ⓢ	Ⓢ	⊗	⊗	⊗

Bi-Parting doors, no shelves
No center stile, 1/8" reveal between doors

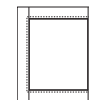

- WC3015BPGL
- WC3315BPGL
- WC3615BPGL
- WC3915BPGL



- WC3015BPMD
- WC3315BPMD
- WC3615BPMD
- WC3915BPMD

18" HIGH

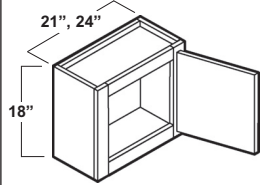

RD	AD	FI	ND	AE	IA	BD	AA
\$	\$	\$	\$	\$	⊗	⊗	⊗

One door, no shelves
Specify RH or LH on Arch styles



- WC2118
- WC2418
- WC2118GL
- WC2418GL



- WC2118MD
- WC2418MD

18" HIGH

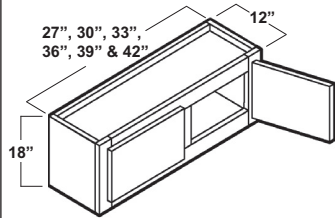

RD	AD	FI	ND	AE	IA	BD	AA
\$	\$	\$	\$	\$	⊗	⊗	⊗

Two doors, no shelves
Mullions not available in all door styles

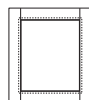

- WC2718
- WC3018
- WC3318
- WC3618
- WC3918
- WC4218



- WC2718GL
- WC3018GL
- WC3318GL
- WC3618GL
- WC3918GL
- WC4218GL
- WC2718MD
- WC3018MD
- WC3318MD
- WC3618MD
- WC3918MD
- WC4218MD

18" HIGH, BI-PARTING

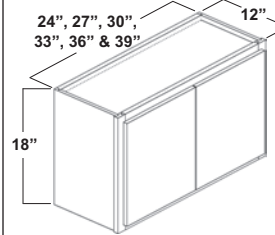

RD	AD	FI	ND	AE	IA	BD	AA
\$	\$	\$	\$	\$	⊗	⊗	⊗

Bi-Parting doors, no shelves
No center stile, 1/8" reveal between doors
Mullions not available in all door styles

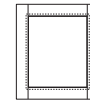

- WC2418BP
- WC2718BP
- WC3018BP
- WC3318BP
- WC3618BP
- WC3918BP



- WC2418BPGL
- WC2718BPGL
- WC3018BPGL
- WC3318BPGL
- WC3618BPGL
- WC3918BPGL
- WC2418BPMD
- WC2718BPMD
- WC3018BPMD
- WC3318BPMD
- WC3618BPMD
- WC3918BPMD

21" HIGH

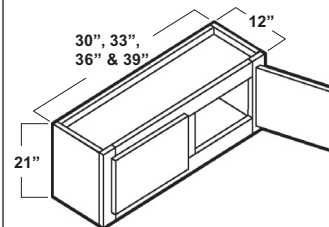

RD	AD	FI	ND	AE	IA	BD	AA
\$	\$	\$	\$	\$	⊗	⊗	⊗

Two doors, no shelves
Mullions not available in all door styles

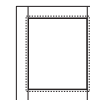

- WC3021
- WC3321
- WC3621
- WC3921



- WC3021GL
- WC3321GL
- WC3621GL
- WC3921GL
- WC3021MD
- WC3321MD
- WC3621MD
- WC3921MD

- Standard
- Ⓢ Available with an Upcharge
- ⚠ Available with Exceptions
- ⊗ Not Available

Refer to pages 0.21-0.22 for Door and Finish Availability Chart

OPTIONS

- RD Reduce Depth
- AE Applied Overlay Ends
- AD Add Depth
- IA Installed Accessories
- FI Finished Interior
- BD Bottom Drawers
- ND No Doors/No Drawers
- AA ADA Adaptable

21" HIGH, BI-PARTING

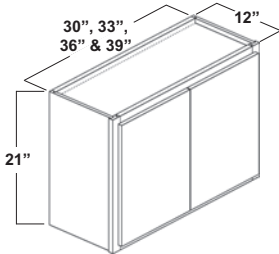

RD	AD	FI	ND	AE	IA	BD	AA
Ⓢ	Ⓢ	Ⓢ	Ⓢ	Ⓢ	⊗	⊗	⊗

Bi-Parting doors, no shelves
 No center stile, 1/8" reveal between doors
 Mullions not available in all door styles

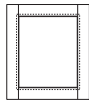

- WC3021BP
- WC3321BP
- WC3621BP
- WC3921BP

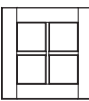

- WC3021BPGL
- WC3321BPGL
- WC3621BPGL
- WC3921BPGL
- WC3021BPMD
- WC3321BPMD
- WC3621BPMD
- WC3921BPMD

24" HIGH

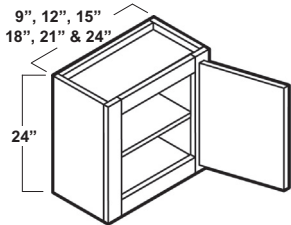

RD	AD	FI	ND	AE	IA	BD	AA
Ⓢ	Ⓢ	Ⓢ	Ⓢ	Ⓢ	⊗	⊗	⊗

One door, one shelf
 Specify RH or LH on Arch styles

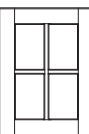
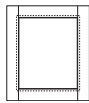

- WC924
- WC1224
- WC1524
- WC1824
- WC2124
- WC2424
- WC924GL
- WC1224GL
- WC1524GL
- WC1824GL
- WC2124GL
- WC2424GL
- WC1224MD
- WC1524MD
- WC1824MD
- WC2124MD
- WC2424MD

24" HIGH

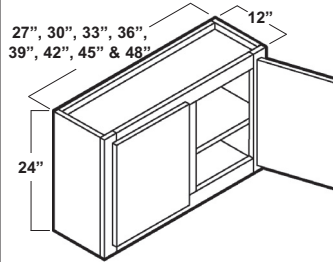

RD	AD	FI	ND	AE	IA	BD	AA
Ⓢ	Ⓢ	Ⓢ	Ⓢ	Ⓢ	⊗	⊗	⊗

Two doors, one adjustable shelf
 Mullions not available in all door styles

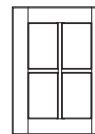
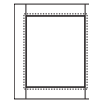

- WC2724
- WC3024
- WC3324
- WC3624
- WC3924
- WC4224
- WC4524
- WC4824
- WC2724GL
- WC3024GL
- WC3324GL
- WC3624GL
- WC3924GL
- WC4224GL
- WC4524GL
- WC4824GL
- WC2724MD
- WC3024MD
- WC3324MD
- WC3624MD
- WC3924MD
- WC4224MD
- WC4524MD
- WC4824MD

24" HIGH, BI-PARTING

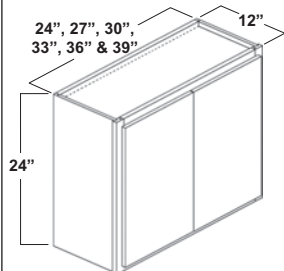

RD	AD	FI	ND	AE	IA	BD	AA
\$	\$	\$	\$	\$	⊗	⊗	⊗

Bi-Parting doors, one adjustable shelf
No center stile, 1/8" reveal between doors

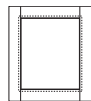

- WC2424BP
- WC2724BP
- WC3024BP
- WC3324BP
- WC3624BP
- WC3924BP

- WC2424BPGL
- WC2724BPGL
- WC3024BPGL
- WC3324BPGL
- WC3624BPGL
- WC3924BPGL

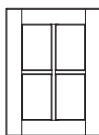

- WC2424BPMD
- WC2724BPMD
- WC3024BPMD
- WC3324BPMD
- WC3624BPMD
- WC3924BPMD

27" HIGH

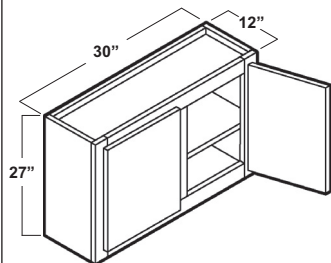

RD	AD	FI	ND	AE	IA	BD	AA
\$	\$	\$	\$	\$	⊗	⊗	⊗

Two doors, one adjustable shelf

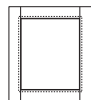

- WC3027
- WC3027GL
- WC3027MD

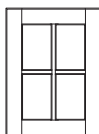

30" HIGH

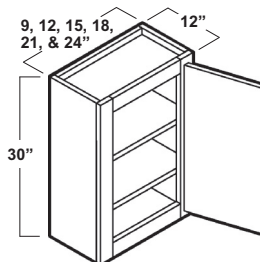

RD	AD	FI	ND	AE	IA	BD	AA
\$	\$	\$	\$	\$	⊗	⊗	⊗

One door, two adjustable shelves
Specify RH or LH on Arch styles

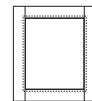

- WC930
- WC1230
- WC1530
- WC1830
- WC2130
- WC2430

- WC930GL
- WC1230GL
- WC1530GL
- WC1830GL
- WC2130GL
- WC2430GL

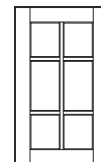

- WC1230MD
- WC1530MD
- WC1830MD
- WC2130MD
- WC2430MD

- Standard
- Ⓢ Available with an Upcharge
- ⚠ Available with Exceptions
- ⊗ Not Available

Refer to pages 0.21-0.22 for Door and Finish Availability Chart

OPTIONS

- RD Reduce Depth
- AE Applied Overlay Ends
- AD Add Depth
- IA Installed Accessories
- FI Finished Interior
- BD Bottom Drawers
- ND No Doors/No Drawers
- AA ADA Adaptable

30" HIGH

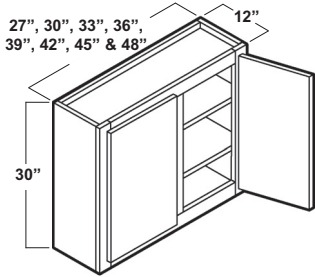

RD	AD	FI	ND	AE	IA	BD	AA
Ⓢ	Ⓢ	Ⓢ	Ⓢ	Ⓢ	⊗	⊗	⊗

Two doors, two adjustable shelves

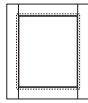

- WC2730
- WC3030
- WC3330
- WC3630
- WC3930
- WC4230
- WC4530
- WC4830

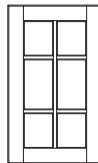

- WC2730GL
- WC3030GL
- WC3330GL
- WC3630GL
- WC3930GL
- WC4230GL
- WC4530GL
- WC4830GL
- WC2730MD
- WC3030MD
- WC3330MD
- WC3630MD
- WC3930MD
- WC4230MD
- WC4530MD
- WC4830MD

30" HIGH, BI-PARTING

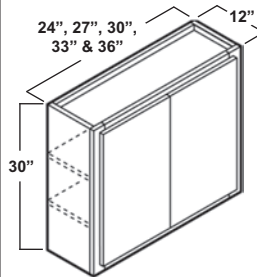

RD	AD	FI	ND	AE	IA	BD	AA
Ⓢ	Ⓢ	Ⓢ	Ⓢ	Ⓢ	⊗	⊗	⊗

Bi-Parting doors, two adjustable shelves
No center stile, 1/8" reveal between doors

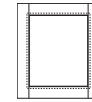

- WC2430BP
- WC2730BP
- WC3030BP
- WC3330BP
- WC3630BP

- WC2430BPGL
- WC2730BPGL
- WC3030BPGL
- WC3330BPGL
- WC3630BPGL

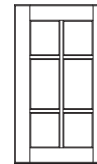

- WC2430BPMD
- WC2730BPMD
- WC3030BPMD
- WC3330BPMD
- WC3630BPMD

36" HIGH

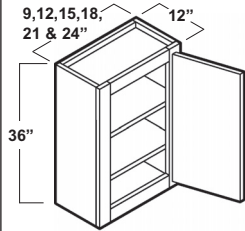

RD	AD	FI	ND	AE	IA	BD	AA
\$	\$	\$	\$	\$	⊗	⊗	⊗

One door, two adjustable shelves
Specify RH or LH on Arch styles

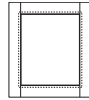

- WC936
- WC1236
- WC1536
- WC1836
- WC2136
- WC2436

- WC936GL
- WC1236GL
- WC1536GL
- WC1836GL
- WC2136GL
- WC2436GL

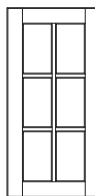

- WC1236MD
- WC1536MD
- WC1836MD
- WC2136MD
- WC2436MD

36" HIGH

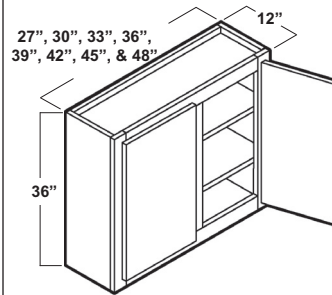

RD	AD	FI	ND	AE	IA	BD	AA
\$	\$	\$	\$	\$	⊗	⊗	⊗

Two doors, two adjustable shelves

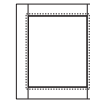

- WC2736
- WC3036
- WC3336
- WC3636
- WC3936
- WC4236
- WC4536
- WC4836

- WC2736GL
- WC3036GL
- WC3336GL
- WC3636GL
- WC3936GL
- WC4236GL
- WC4536GL
- WC4836GL

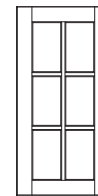

- WC2736MD
- WC3036MD
- WC3336MD
- WC3636MD
- WC3936MD
- WC4236MD
- WC4536MD
- WC4836MD

- Standard
- Ⓢ Available with an Upcharge
- ⚠ Available with Exceptions
- ⊗ Not Available

Refer to pages 0.21-0.22 for Door and Finish Availability Chart

OPTIONS

- RD Reduce Depth
- AE Applied Overlay Ends
- AD Add Depth
- IA Installed Accessories
- FI Finished Interior
- BD Bottom Drawers
- ND No Doors/No Drawers
- AA ADA Adaptable

36" HIGH, BI-PARTING

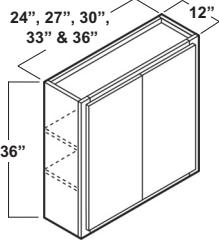

RD	AD	FI	ND	AE	IA	BD	AA
Ⓢ	Ⓢ	Ⓢ	Ⓢ	Ⓢ	⊗	⊗	⊗

Bi-Parting doors, two adjustable shelves
No center stile, 1/8" reveal between doors

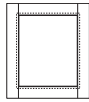

- WC2436BP
- WC2736BP
- WC3036BP
- WC3336BP
- WC3636BP

- WC2436BPGL
- WC2736BPGL
- WC3036BPGL
- WC3336BPGL
- WC3636BPGL

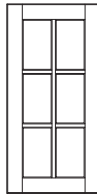

- WC2436BPM
- WC2736BPM
- WC3036BPM
- WC3336BPM
- WC3636BPM

42" HIGH

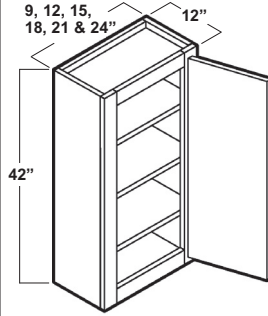

RD	AD	FI	ND	AE	IA	BD	AA
Ⓢ	Ⓢ	Ⓢ	Ⓢ	Ⓢ	⊗	⊗	⊗

One door, three adjustable shelves
Specify RH or LH on Arch styles

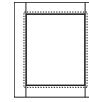

- WC942
- WC1242
- WC1542
- WC1842
- WC2142
- WC2442

- WC942GL
- WC1242GL
- WC1542GL
- WC1842GL
- WC2142GL
- WC2442GL



- WC1242MD
- WC1542MD
- WC1842MD
- WC2142MD
- WC2442MD

42" HIGH

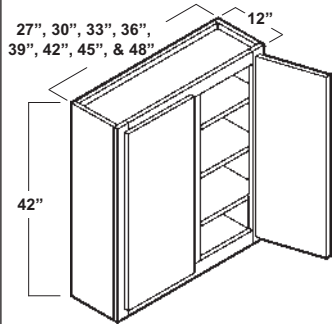

RD	AD	FI	ND	AE	IA	BD	AA
\$	\$	\$	\$	\$	⊗	⊗	⊗

Two doors, three adjustable shelves



- WC2742
- WC3042
- WC3342
- WC3642
- WC3942
- WC4242
- WC4542
- WC4842

- WC2742GL
- WC3042GL
- WC3342GL
- WC3642GL
- WC3942GL
- WC4242GL
- WC4542GL
- WC4842GL

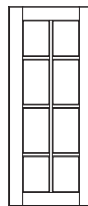

- WC2742MD
- WC3042MD
- WC3342MD
- WC3642MD
- WC3942MD
- WC4242MD
- WC4542MD
- WC4842MD

42" HIGH, BI-PARTING

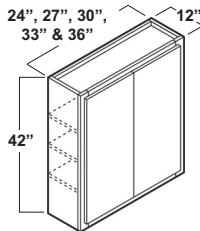

RD	AD	FI	ND	AE	IA	BD	AA
\$	\$	\$	\$	\$	⊗	⊗	⊗

Bi-Parting doors, three adjustable shelves
No center stile, 1/8" reveal between doors



- WC2442BP
- WC2742BP
- WC3042BP
- WC3342BP
- WC3642BP

- WC2442BPGL
- WC2742BPGL
- WC3042BPGL
- WC3342BPGL
- WC3642BPGL



- WC2442BPMD
- WC2742BPMD
- WC3042BPMD
- WC3342BPMD
- WC3642BPMD

- Standard
- Ⓢ Available with an Upcharge
- ⚠ Available with Exceptions
- ⊗ Not Available

Refer to pages 0.21-0.22 for Door and Finish Availability Chart

OPTIONS

- RD Reduce Depth
- AE Applied Overlay Ends
- AD Add Depth
- IA Installed Accessories
- FI Finished Interior
- BD Bottom Drawers
- ND No Doors/No Drawers
- AA ADA Adaptable

12" Deep 2 Faced Wall Cabinets

18" HIGH ISLAND

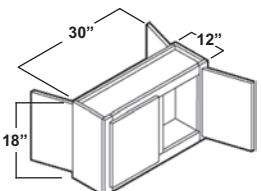

IW3018



IW3018GL



IW3018MD

RD	AD	FI	ND	AE	IA	BD	AA
Ⓢ	Ⓢ	Ⓢ	Ⓢ	Ⓢ	⊗	⊗	⊗

Two doors each side, no shelves
All doors are glass

18" HIGH ISLAND, BI-PARTING

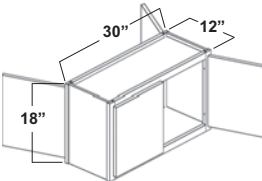

IW3018BP



IW3018BPGL



IW3018BPMD

RD	AD	FI	ND	AE	IA	BD	AA
Ⓢ	Ⓢ	Ⓢ	Ⓢ	Ⓢ	⊗	⊗	⊗

Bi-Parting doors each side, no shelves
No center stile, 1/8" reveal between doors
All doors are glass

30" HIGH ISLAND

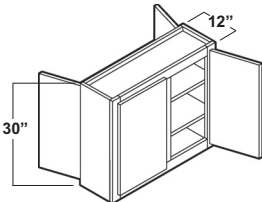

IW3030



IW3030GL

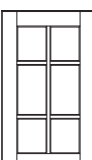

IW3030MD

RD	AD	FI	ND	AE	IA	BD	AA
Ⓢ	Ⓢ	Ⓢ	Ⓢ	Ⓢ	⊗	⊗	⊗

Two doors each side, two adjustable shelves
All doors are glass

30" HIGH ISLAND, BI-PARTING

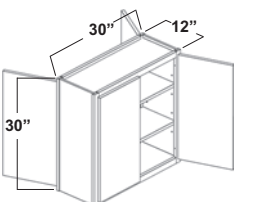

IW3030BP



IW3030BPGL

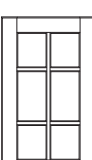

IW3030BPMD

RD	AD	FI	ND	AE	IA	BD	AA
Ⓢ	Ⓢ	Ⓢ	Ⓢ	Ⓢ	⊗	⊗	⊗

Bi-Parting doors each side, two adjustable shelves
No center stile, 1/8" reveal between doors
All doors are glass

Refrigerator Wall Cabinets

REFRIGERATOR WALL CABINETS

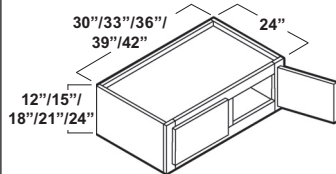

RD	AD	FI	ND	AE	IA	BD	AA
\$	⊗	\$	\$	\$	⊗	⊗	⊗

One shelf in 24" high
For use over refrigerators
The use of extra support is recommended

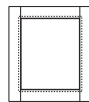

- RW3012
- RW3312
- RW3612
- RW3912
- RW4212



- RW3012GL
- RW3312GL
- RW3612GL
- RW3912GL
- RW4212GL



- RW3012MD
- RW3312MD
- RW3612MD
- RW3912MD
- RW4212MD

- RW3015
- RW3315
- RW3615
- RW3915
- RW4215

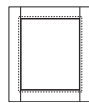

- RW3015GL
- RW3315GL
- RW3615GL
- RW3915GL
- RW4215GL

- RW3015MD
- RW3315MD
- RW3615MD
- RW3915MD
- RW4215MD

REFRIGERATOR WALL CABINETS (continued)

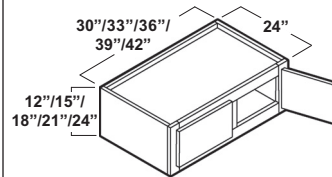

RD	AD	FI	ND	AE	IA	BD	AA
\$	⊗	\$	\$	\$	⊗	⊗	⊗

One shelf in 24" high
For use over refrigerators
The use of extra support is recommended

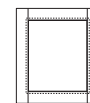

- RW3018
- RW3318
- RW3618
- RW3918
- RW4218

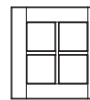

- RW3018GL
- RW3318GL
- RW3618GL
- RW3918GL
- RW4218GL

- RW3018MD
- RW3318MD
- RW3618MD
- RW3918MD
- RW4218MD

- RW3021
- RW3321
- RW3621
- RW3921
- RW4221

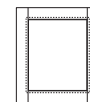

- RW3021GL
- RW3321GL
- RW3621GL
- RW3921GL
- RW4221GL

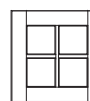

- RW3021MD
- RW3321MD
- RW3621MD
- RW3921MD
- RW4221MD

- Standard
- Ⓢ Available with an Upcharge
- ⚠ Available with Exceptions
- ⊗ Not Available

Refer to pages 0.21-0.22 for Door and Finish Availability Chart

OPTIONS

- RD Reduce Depth
- AE Applied Overlay Ends
- AD Add Depth
- IA Installed Accessories
- FI Finished Interior
- BD Bottom Drawers
- ND No Doors/No Drawers
- AA ADA Adaptable

REFRIGERATOR WALL CABINETS (continued)

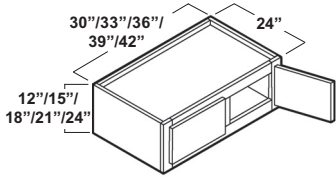

RD	AD	FI	ND	AE	IA	BD	AA
Ⓢ	⊗	Ⓢ	Ⓢ	Ⓢ	⊗	⊗	⊗

One shelf in 24" high
For use over refrigerators
The use of extra support is recommended

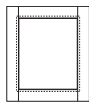

- RW3024
- RW3324
- RW3624
- RW3924
- RW4224

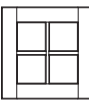

- RW3024GL
- RW3324GL
- RW3624GL
- RW3924GL
- RW4224GL

- RW3024MD
- RW3324MD
- RW3624MD
- RW3924MD
- RW4224MD

REFRIGERATOR WALL CABINETS, BI-PARTING

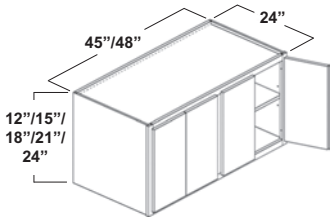

RD	AD	FI	ND	AE	IA	BD	AA
Ⓢ	⊗	Ⓢ	Ⓢ	Ⓢ	⊗	⊗	⊗

Four doors
One shelf in 24" high
For use over refrigerators
The use of extra support is recommended
Available as Bi-Parting only

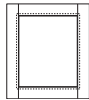

- RW4512BP
- RW4812BP

- RW4512BPGL
- RW4812BPGL

- RW4512BPMD
- RW4812BPMD

- RW4515BP
- RW4815BP

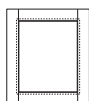

- RW4515BPGL
- RW4815BPGL

- RW4515BPMD
- RW4815BPMD

REFRIGERATOR WALL CABINETS, BI-PARTING (continued)

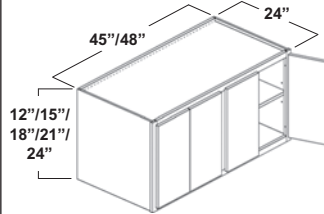

RD	AD	FI	ND	AE	IA	BD	AA
Ⓢ	⊗	Ⓢ	Ⓢ	Ⓢ	⊗	⊗	⊗

Four doors
One shelf in 24" high
For use over refrigerators
The use of extra support is recommended
Available as Bi-Parting only

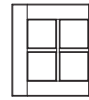
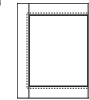

- RW4518BP
- RW4818BP

- RW4518BPGL
- RW4818BPGL

- RW4518BPMD
- RW4818BPMD

- RW4521BP
- RW4821BP

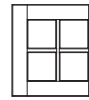
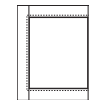

- RW4521BPGL
- RW4821BPGL

- RW4521BPMD
- RW4821BPMD

- RW4524BP
- RW4824BP

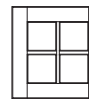
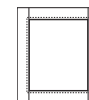

- RW4524BPGL
- RW4824BPGL

- RW4524BPMD
- RW4824BPMD

Wall Corner Cabinets

24" HIGH

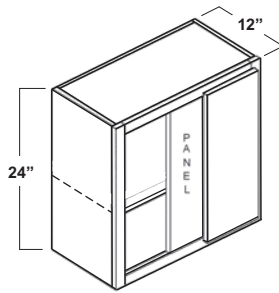

RD	AD	FI	ND	AE	IA	BD	AA
\$	\$	\$	\$	\$	⊗	⊗	⊗

One door, one adjustable shelf
 LH as shown
 Specify RH or LH on Arch styles
 5-1/4" center stile
 Can be pulled up to 3" from corner wall
 When finishing end for Plywood, specify blind and end to be finished.

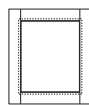

WCC2424
WCC3024
WCC3624

WCC2424GL
WCC3024GL
WCC3624GL



WCC2424MD
WCC3024MD
WCC3624MD

30" & 36" HIGH

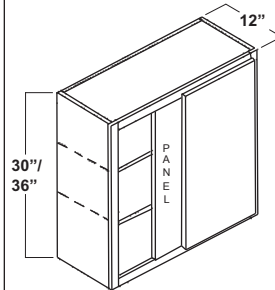

RD	AD	FI	ND	AE	IA	BD	AA
\$	\$	\$	\$	\$	⊗	⊗	⊗

One door, two adjustable shelves
 LH as shown
 Specify RH or LH on Arch styles
 5-1/4" center stile
 Can be pulled up to 3" from corner wall
 When finishing end for Plywood, specify blind and end to be finished.

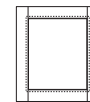

WCC2430
WCC3030
WCC3630

WCC2430GL
WCC3030GL
WCC3630GL

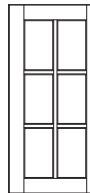

WCC2430MD
WCC3030MD
WCC3630MD

WCC2436
WCC3036
WCC3636

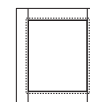

WCC2436GL
WCC3036GL
WCC3636GL

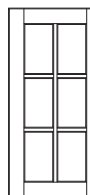

WCC2436MD
WCC3036MD
WCC3636MD

Cabinet Width	Actual Width	Center Stile Width	Outside Stile Width	Min. Install Distance	Min. Center Stile Exposure	Min. Total Space Filled	Max. Install Distance	Max. Center Stile Exposure	Max. Total Space Filled
				SOL / FOL*	SOL / FOL*	SOL / FOL*		SOL / FOL*	
WCC 24	24"	5-1/4"	1-1/2"	0" / 1"	1" / 1-3/16"	24" / 25"	3"	4" / 3-3/16"	27"
WCC 30	30"	5-1/4"	1-1/2"	0" / 1"	1" / 1-3/16"	30" / 31"	3"	4" / 3-3/16"	33"
WCC 36	36"	5-1/4"	1-1/2"	0" / 1"	1" / 1-3/16"	36" / 37"	3"	4" / 3-3/16"	39"
WCC 42	42"	5-1/4"	1-1/2"	0" / 1"	1" / 1-3/16"	42" / 43"	3"	4" / 3-3/16"	45"
WCC 48	48"	5-1/4"	1-1/2"	0" / 1"	1" / 1-3/16"	48" / 49"	3"	4" / 3-3/16"	51"

SOL = Standard Overlay Cabinet Style
 FOL = Full Overlay Cabinet Style

Note: All Full Overlay Blind Cabinets require an adjacent 3" filler
 A 3" filler for all Standard Overlay Blind Cabinets is recommended

* Due to the nature of Full Overlay construction, these cabinets must be installed at least 1" from adjacent wall

- Standard
- Ⓢ Available with an Upcharge
- ⚠ Available with Exceptions
- ⊗ Not Available

Refer to pages 0.21-0.22 for Door and Finish Availability Chart

OPTIONS

- RD Reduce Depth
- AE Applied Overlay Ends
- AD Add Depth
- IA Installed Accessories
- FI Finished Interior
- BD Bottom Drawers
- ND No Doors/No Drawers
- AA ADA Adaptable

30" & 36" HIGH

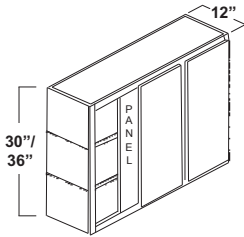

RD	AD	FI	ND	AE	IA	BD	AA
Ⓢ	Ⓢ	Ⓢ	Ⓢ	Ⓢ	⊗	⊗	⊗

Two doors, two adjustable shelves
Specify RH or LH on Arch styles.
LH as shown.
5-1/4" blind panel
When finishing end for Plywood, specify
blind and end to be finished



- WCC4230
- WCC4830
- WCC4230GL
- WCC4830GL
- WCC4230MD
- WCC4830MD

- WCC4236
- WCC4836

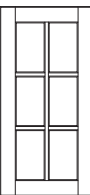
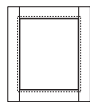

- WCC4236GL
- WCC4836GL
- WCC4236MD
- WCC4836MD

42" HIGH

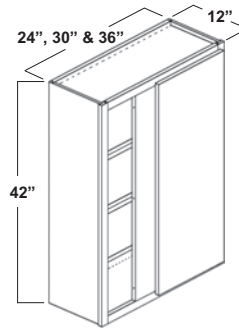

RD	AD	FI	ND	AE	IA	BD	AA
Ⓢ	Ⓢ	Ⓢ	Ⓢ	Ⓢ	⊗	⊗	⊗

One door, three adjustable shelves
Specify RH or LH on Arch styles.
LH as shown.
5-1/4" blind panel
Can be pulled up to 3" from corner wall
When finishing end for Plywood, specify
blind and end to be finished

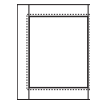

- WCC2442
- WCC3042
- WCC3642
- WCC2442GL
- WCC3042GL
- WCC3642GL

- WCC2442MD
- WCC3042MD
- WCC3642MD

42" HIGH

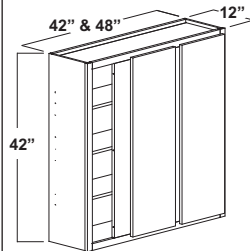

RD	AD	FI	ND	AE	IA	BD	AA
Ⓢ	Ⓢ	Ⓢ	Ⓢ	Ⓢ	⊗	⊗	⊗

Two doors, three adjustable shelves
Specify RH or LH on Arch styles.
LH as shown.
5-1/4" blind panel
When finishing end for Plywood, specify
blind and end to be finished

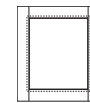

- WCC4242
- WCC4842
- WCC4242GL
- WCC4842GL
- WCC4242MD
- WCC4842MD

Cabinet Width	Actual Width	Center Stile Width	Outside Stile Width	Min. Install Distance	Min. Center Stile Exposure	Min. Total Space Filled	Max. Install Distance	Max. Center Stile Exposure	Max. Total Space Filled
				SOL / FOL*	SOL / FOL*	SOL / FOL*		SOL / FOL*	
WCC 24	24"	5-1/4"	1-1/2"	0" / 1"	1" / 1-3/16"	24" / 25"	3"	4" / 3-3/16"	27"
WCC 30	30"	5-1/4"	1-1/2"	0" / 1"	1" / 1-3/16"	30" / 31"	3"	4" / 3-3/16"	33"
WCC 36	36"	5-1/4"	1-1/2"	0" / 1"	1" / 1-3/16"	36" / 37"	3"	4" / 3-3/16"	39"
WCC 42	42"	5-1/4"	1-1/2"	0" / 1"	1" / 1-3/16"	42" / 43"	3"	4" / 3-3/16"	45"
WCC 48	48"	5-1/4"	1-1/2"	0" / 1"	1" / 1-3/16"	48" / 49"	3"	4" / 3-3/16"	51"

SOL = Standard Overlay Cabinet Style
FOL = Full Overlay Cabinet Style

Note: All Full Overlay Blind Cabinets require an adjacent 3" filler
A 3" filler for all Standard Overlay Blind Cabinets is recommended

* Due to the nature of Full Overlay construction, these cabinets must be installed at least 1" from adjacent wall

24", 30", 36" & 42" HIGH

EZCW2424

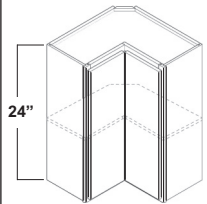

RD	AD	FI	ND	AE	IA	BD	AA
⊗	⊗	§	§	§	⊗	⊗	⊗

Contains 1 adjustable shelf
Specify RH or LH for arch and full overlay styles

EZCW2430
EZCW2436

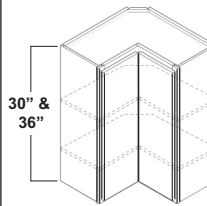

RD	AD	FI	ND	AE	IA	BD	AA
⊗	⊗	§	§	§	⊗	⊗	⊗

Contains 2 adjustable shelves
Specify RH or LH for arch and full overlay styles

EZCW2442

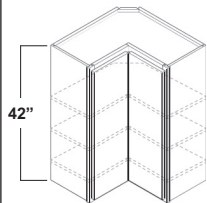

RD	AD	FI	ND	AE	IA	BD	AA
⊗	⊗	§	§	§	⊗	⊗	⊗

Contains 3 adjustable shelves
Specify RH or LH for arch and full overlay styles

Diagonal Wall Cabinets

24" HIGH

CWC2424
CWC2724

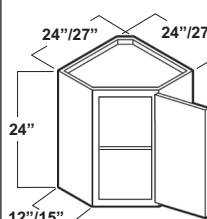

RD	AD	FI	ND	AE	IA	BD	AA
⊗	⊗	§	§	§	⊗	⊗	⊗

CWC2424GL
CWC2724GL

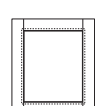

CWC2424MD
CWC2724MD

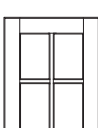

One door, one adjustable shelf
Specify RH or LH on Arch styles
24" CWC's are 12" deep
27" CWC's are 15" deep

30" & 36" HIGH

CWC2430
CWC2730

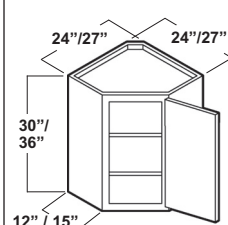

RD	AD	FI	ND	AE	IA	BD	AA
⊗	⊗	§	§	§	⊗	⊗	⊗

CWC2436
CWC2736

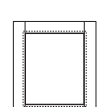

CWC2430GL
CWC2730GL

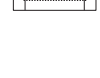

CWC2436GL
CWC2736GL

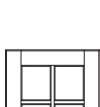

One door, two adjustable shelves
Specify RH or LH on Arch styles
24" CWC's are 12" deep
27" CWC's are 15" deep

CWC2430MD
CWC2730MD

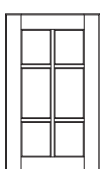

CWC2436MD
CWC2736MD

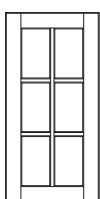

42" HIGH

CWC2442
CWC2742

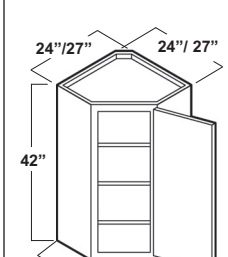

RD	AD	FI	ND	AE	IA	BD	AA
⊗	⊗	§	§	§	⊗	⊗	⊗

CWC2442GL
CWC2742GL

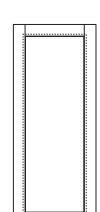

CWC2442MD
CWC2742MD



One door, three adjustable shelves
Specify RH or LH on Arch styles
24" CWC's are 12" deep
27" CWC's are 15" deep

- Standard
- Ⓢ Available with an Upcharge
- ⚠ Available with Exceptions
- ⊗ Not Available

Refer to pages 0.21-0.22 for Door and Finish Availability Chart

OPTIONS

- RD Reduce Depth
- AE Applied Overlay Ends
- AD Add Depth
- IA Installed Accessories
- FI Finished Interior
- BD Bottom Drawers
- ND No Doors/No Drawers
- AA ADA Adaptable

Wall End Angled

24" HIGH

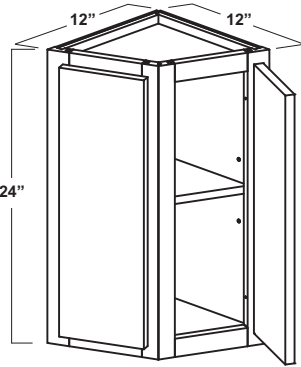

WEA1224

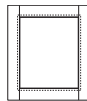

WEA1224GL

RD	AD	FI	ND	AE	IA	BD	AA
⊗	⊗	Ⓢ	Ⓢ	⊗	⊗	⊗	⊗

Two doors, one fixed shelf
 Mullions not available
 Must be installed with one back panel adjacent to a cabinet of equal height with the other back panel attached to the wall

30" & 36" HIGH

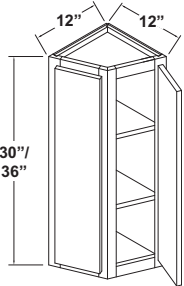

WEA1230

WEA1236

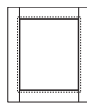

WEA1230GL

WEA1236GL

RD	AD	FI	ND	AE	IA	BD	AA
⊗	⊗	Ⓢ	Ⓢ	⊗	⊗	⊗	⊗

Two doors, two fixed shelves
 Mullions not available
 Must be installed with one back panel adjacent to a cabinet of equal height with the other back panel attached to the wall

42" HIGH

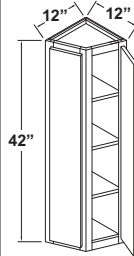

WEA1242

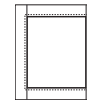

WEA1242GL

RD	AD	FI	ND	AE	IA	BD	AA
⊗	⊗	Ⓢ	Ⓢ	⊗	⊗	⊗	⊗

Two doors, three fixed shelves
 Mullions not available
 Must be installed with one back panel adjacent to a cabinet of equal height with the other back panel attached to the wall

Wall End Cabinets

24" HIGH

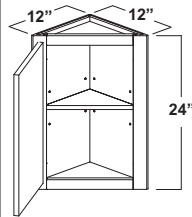

WEC1224

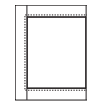

WEC1224GL



WEC1224MD

RD	AD	FI	ND	AE	IA	BD	AA
⊗	⊗	Ⓢ	Ⓢ	⊗	⊗	⊗	⊗

One door, one adjustable shelf
 Specify RH or LH on Arch styles
 Mullions not available in all door styles
 Must be installed with one back panel adjacent to a cabinet of equal height with the other back panel attached to the wall

30" & 36" HIGH

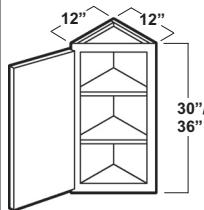

WEC1230

WEC1236

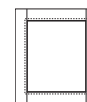

WEC1230GL

WEC1236GL

RD	AD	FI	ND	AE	IA	BD	AA
⊗	⊗	Ⓢ	Ⓢ	⊗	⊗	⊗	⊗

One door, two adjustable shelves
 Specify RH or LH on Arch styles
 Mullions not available in all door styles
 Must be installed with one back panel adjacent to a cabinet of equal height with the other back panel attached to the wall



WEC1230MD

WEC1236MD

42" HIGH

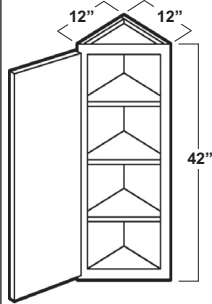

WEC1242

WEC1242GL

WEC1242MD

RD	AD	FI	ND	AE	IA	BD	AA
⊗	⊗	Ⓢ	Ⓢ	⊗	⊗	⊗	⊗

One door, three adjustable shelves
Specify RH or LH on Arch styles
Mullions not available in all door styles
Must be installed with one back panel adjacent to a cabinet of equal height with the other back panel attached to the wall

Microwave Wall Cabinets

30" & 36" HIGH

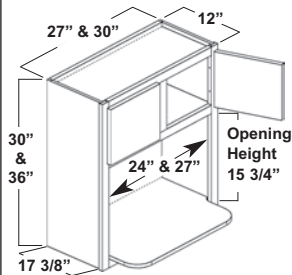

WCMW2730

WCMW3030

WCMW2736

WCMW3036

RD	AD	FI	ND	AE	IA	BD	AA
⊗	⊗	●	Ⓢ	Ⓢ	⊗	⊗	⊗

Two doors, no shelves
Interior is finished to match the exterior
Depth of bottom shelf is 17 3/8"

WCMW2730GL

WCMW3030GL

WCMW2736GL

WCMW3036GL

WCMW2730MD

WCMW3030MD

WCMW2736MD

WCMW3036MD

30" & 36" HIGH, BI-PARTING

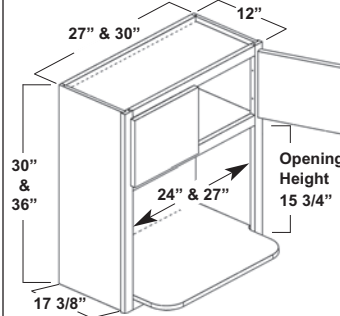

WCMW2730BP

WCMW3030BP

WCMW2736BP

WCMW3036BP

RD	AD	FI	ND	AE	IA	BD	AA
⊗	⊗	●	Ⓢ	Ⓢ	⊗	⊗	⊗

Bi-Parting doors, no shelves
No center stile, 1/8" reveal between doors
Interior is finished to match the exterior

WCMW2730BPGL

WCMW3030BPGL

WCMW2736BPGL

WCMW3036BPGL

WCMW2730BPMD

WCMW3030BPMD

WCMW2736BPMD

WCMW3036BPMD

42" HIGH

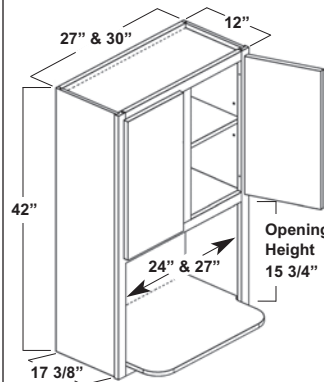

WCMW2742

WCMW3042

RD	AD	FI	ND	AE	IA	BD	AA
⊗	⊗	●	Ⓢ	Ⓢ	⊗	⊗	⊗

Two doors, one shelf
Interior is finished to match the exterior

WCMW2742GL

WCMW3042GL

WCMW2742MD

WCMW3042MD

- Standard
- Ⓢ Available with an Upcharge
- ⚠ Available with Exceptions
- ⊗ Not Available

Refer to pages 0.21-0.22 for Door and Finish Availability Chart

OPTIONS

- RD Reduce Depth
- AE Applied Overlay Ends
- AD Add Depth
- IA Installed Accessories
- FI Finished Interior
- BD Bottom Drawers
- ND No Doors/No Drawers
- AA ADA Adaptable

42" HIGH, BI-PARTING

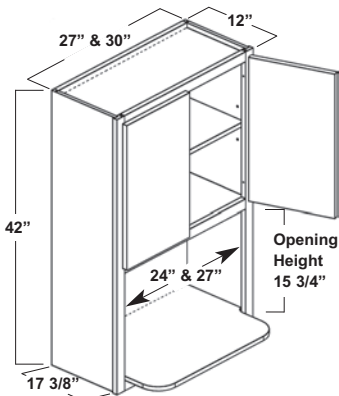

- WCMW2742BP**
- WCMW3042BP**
- WCMW2742BPGL**
- WCMW3042BPGL**
- WCMW2742BPMD**
- WCMW3042BPMD**

- RD ⊗
- AD ⊗
- FI ●
- ND ⊗
- AE Ⓢ
- IA Ⓢ
- BD ⊗
- AA ⊗

Bi-Parting doors, one shelf
 No center stile, 1/8" reveal between doors
 Interior is finished to match the exterior

MICROWAVE WALL CABINET

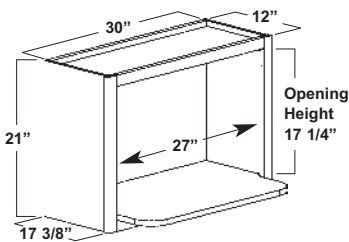

WCM3021

No doors, no shelves
 Interior is finished to match the exterior

LATTICE WINE RACK CABINET

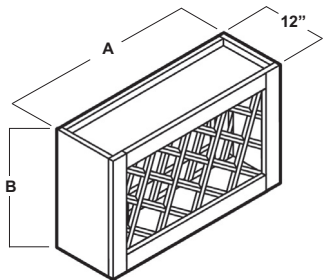

- WRC2430F**
- WRC2436F**
- WRC1830F**
- WRC3018F**

	A	B	Number of Bottles
WRC1830F	18"	30"	11
WRC3018F	30"	18"	11
WRC2430F	24"	30"	17
WRC2436F	24"	36"	23

Not available unfinished
 Width modification not available
 Interior is finished to match exterior
 Plywood can be ordered
Not available in Birch

PLATE RACK CABINET

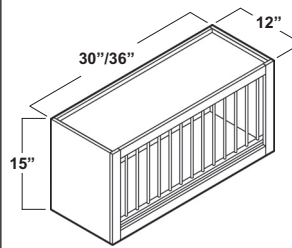

- WC3015PRF**
- WC3615PRF**

Accommodates 10" plates
 4 front dowels removable for cleaning
 Interior is finished to match exterior
 Not available unfinished
 11" plate size is largest this cabinet can accommodate
 Increasing depth is not recommended
 Plywood can be ordered
Not available in Birch

BOOKCASES

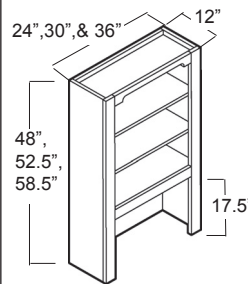

- BC2448F**
- BC3048F**
- BC3648F**
- BC2452F**
- BC3052F**
- BC3652F**
- BC2458F**

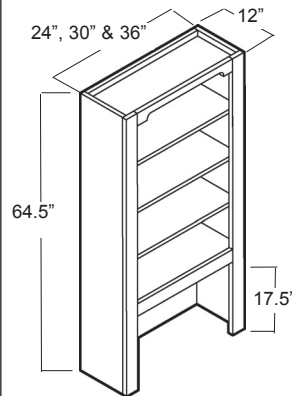

- BC3058F**
- BC3658F**
- BC2464F**
- BC3064F**
- BC3664F**

Bottom shelf to top of countertop is 17-1/2"
 Bottom shelf is fixed
 Two moveable shelves in 48"/52-1/2"/58-1/2" high
 Three moveable shelves in 64" high
 Interior is finished to match exterior
 Plywood can be ordered

DESK ORGANIZERS

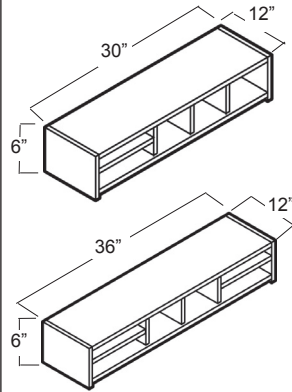

DO30

DO36

Interior finished to match exterior
Not available in plywood
Not available in Birch

SPICE DRAWER CABINET, WINE CUBE CABINET

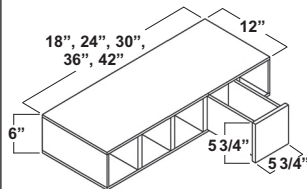

Cabinet shown horizontal with one spice drawer box, SPDBX

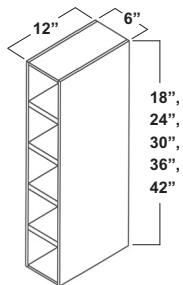

Cabinet shown vertical

	Drawers
18"	3
24"	4
30"	5
36"	6
42"	7

Back not finished
Not intended for end of run
Interior finished to match
Not available in plywood
Not available in Birch

SPWC18

SPWC24

SPWC30

SPWC36

SPWC42

SPDBX

APPLIANCE HUTCH

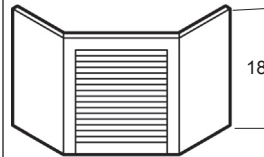

AH

Recess under CWC
Install before CWC
Shipped assembled
Wooden pull included
Not available in Birch

CORNER SHELF TOP

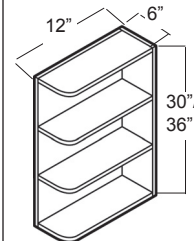

CS630

CS636

CS642

CSTP126

RH as shown

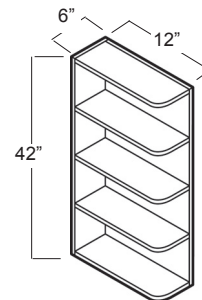

LH as shown

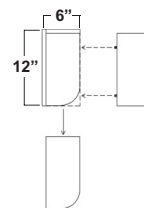

Designate LH or RH when ordering Thermofoil

CSTP126 is a square top for use with crown moldings and is finished on both sides (not pictured)

Must be installed with back panel attached to a wall and side panel attached to a cabinet. If side panel exposed, an Overlay End will need to be used to finish.

Shelves come standard as wood in non-Thermofoil

Not available in Birch

SCALLOPED WINE RACK

WR

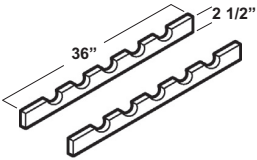

Scalloped wood
Trim in 3" increments

STEMWARE HOLDER

SH

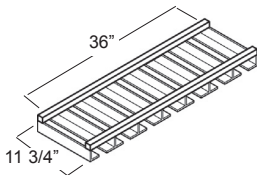

Trimmable
May not accommodate all glass sizes

WALL FILLER PULLOUT ORGANIZER

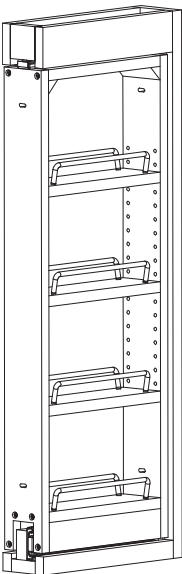

Wall filler applied to front of organizer (order separately)
Designed to install between cabinets

WFPO330
3" wide, 30" high
1 fixed shelf,
3 adjustable shelves

WFPO630
6" wide, 30" high
1 fixed shelf,
3 adjustable shelves

WFPO336
3" wide, 36" high
1 fixed shelf,
4 adjustable shelves

WFPO636
6" wide, 36" high
1 fixed shelf,
4 adjustable shelves

WFPO342
3" wide, 42" high
1 fixed shelf,
5 adjustable shelves

WFPO642
6" wide, 42" high
1 fixed shelf,
5 adjustable shelves

ADJUSTABLE DOOR SPICE RACKS

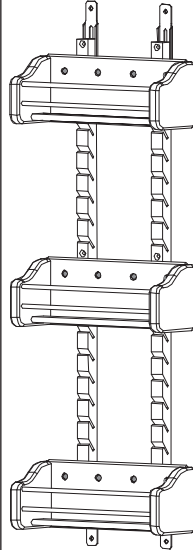

ADSR1530
For WC1530
3 Adjustable Trays

ADSR1830
For WC1830
3 Adjustable Trays

ADSR1536
For WC1536
4 Adjustable Trays

ADSR1836
For WC1836
4 Adjustable Trays

ADSR1542
For WC1542
4 Adjustable Trays

ADSR1842
For WC1842
4 Adjustable Trays

LAZY SUSAN SHELVES

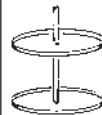

2 - 20" Diagonal **RLS30**

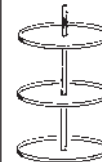

3 - 20" Diagonal **RLS36**

3 - 20" Diagonal **RLS42**

For use in diagonal corner wall cabinets
Designate White (W) or Almond (A) when ordering

Heritage Collection Wood Range Hoods

ARCHED VALANCE

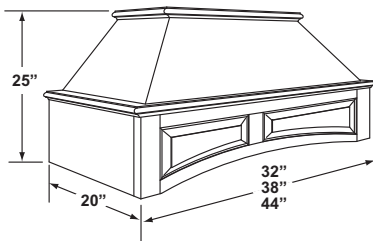

RHA30
RHA36
RHA42

Available in 30", 36", and 42"
Independent Unit - must be attached to wall and cannot be attached to adjacent cabinets
Exhaust system is not included
For use with blower
Liner included
Ductless Kit available
Check local building codes for installation requirements
Installation instructions and hardware are included
No modifications available

STRAIGHT VALANCE

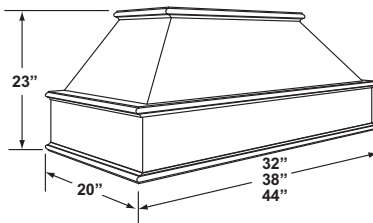

RHST30
RHST36
RHST42

Available in 30", 36", and 42"
Independent Unit - must be attached to wall and cannot be attached to adjacent cabinets
Exhaust system is not included
For use with blower
Liner included
Ductless Kit available
Check local building codes for installation requirements
Installation instructions and hardware are included
No modifications available

CHIMNEY FOR HERITAGE COLLECTION

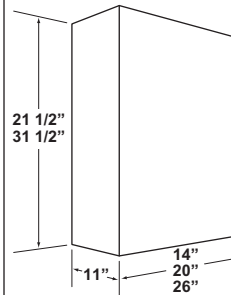

RHC31/30*
RHC31/36*
RHC31/42*
RHC21/30*
RHC21/36*
RHC21/42*

1/2" Plywood
Available in 31.5" and 21.5" heights
Can be used with 30", 36", and 42" straight and arched wood range hoods
Trimable to desired height
***Please Note: Dimensions appear height x width**

BLOWERS

(Requires 2 - 40W Candelabra Bulbs) **RHBUDHL390**
(Requires 2 - 20W Halogen Bulbs) **RHBUDHL500**

DUCTLESS KITS

Not pictured **DCK1**
For use with RHBUDHL390

Not pictured **DCK3**
For use with RHBUDHL500

RANGE HOOD, GALLEY RAIL

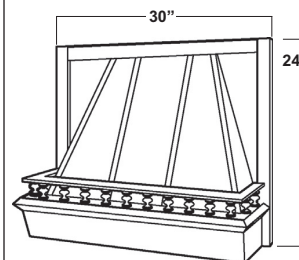

RH30

Galley Rail shipped loose
Use RHBUDHL390 for Blower
Use DCK1 for Ductless Kit
Depth is 18-1/4"



MARSH CABINETS

NOTES

WALLS

Base Cabinets

Construction Options and Modifications

PC - Plywood Construction

FX - Wood Dovetail Drawer with Soft Close Feature

RD - Reduce Depth

AD - Added Depth

ND - No Doors/No Drawers

FI - Finished Interior

AE - Applied Overlay Ends

IA - Installed Accessories

BD - Bottom Drawers

How to read item code:

PB 30
Item Width

Option Chart Symbols

- Standard
- ☒ Available with an Upcharge
- ⚠ Available with Exceptions
- ⊗ Not Available

Reference Modifications Table on Page 0.27

Features:

- ◆ Cabinet interior is laminate with a natural maple grain pattern. White interior will be used on Fairmont and Alpine cabinets. Note, when ordering Fairmont and Alpine in Plywood, interior will be natural maple unless ordered with Finished Interior.
- ◆ Hinges are fully concealed 6-way adjustable.
- ◆ Right-hand hinging standard on single door cabinets.
- ◆ Arch door styles not available in base cabinets.
- ◆ Drawer cabinets with a reduced depth of more than 18" will receive a false drawer front unless upgraded to FX.
- ◆ Standard cabinet has a 3/4 extension, particleboard drawer. Plywood Cabinet (PC) has a 3/4 extension, plywood drawer as standard.
- ◆ Shelves are half-depth; installed at middle position.
- ◆ Cabinets have unfinished toe kick. A Toe Kick (TK) or Toe Plate (TP) must be ordered to finish.
- ◆ Please refer to Cabinet References (pages 0.09-0.18) for decorative hardware requirements.
- ◆ Soft Close integrated hinge on Full Overlay lines.

Drawer Upgrade Option:

- ◆ FX: Wood dovetail drawer; Full Extension with Soft Close slide (add/subtract \$92 per drawer to list).
- ◆ FX: Can accommodate cabinet depth of 12" deep.
- ◆ FX: Standard in Full Overlay lines

Options:

Available options are noted beside each cabinet.

- ◆ Depth Change: A reduction in 3" increments with 6" being minimum depth allowable.
- ◆ No Doors: Finished Interior is not included standard in this option.
- ◆ Finished Interior: Glazed cabinets will not have a glazed interior.
- ◆ Applied Overlay Ends: Use an Overlay End to flush out an end. This is required when applying a decorative door.
- ◆ Bottom Drawers: Check Options Chart beside cabinet for availability.

- Standard
- Ⓢ Available with an Upcharge
- ⚠ Available with Exceptions
- ⊗ Not Available

Refer to pages 0.21-0.22 for Door and Finish Availability Chart

OPTIONS

- RD Reduce Depth
- AE Applied Overlay Ends
- AD Add Depth
- IA Installed Accessories
- FI Finished Interior
- BD Bottom Drawers
- ND No Doors/No Drawers
- AA ADA Adaptable

BASE FULL HEIGHT

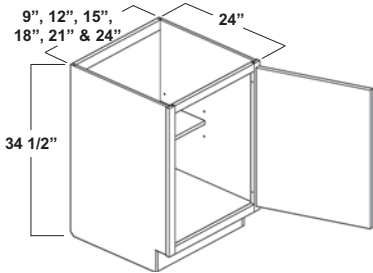

- BFH9
- BFH12
- BFH15
- BFH18
- BFH21
- BFH24

RD	AD	FI	ND	AE	IA	BD	AA
Ⓢ	⊗	Ⓢ	Ⓢ	Ⓢ	Ⓢ	⊗	Ⓢ

One door, one half-depth adjustable shelf

BASE FULL HEIGHT

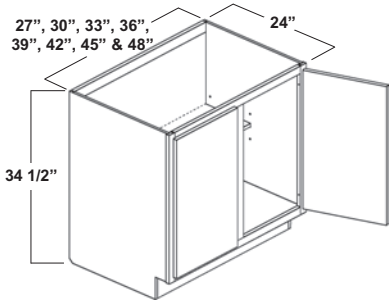

- BFH27
- BFH30
- BFH33
- BFH36
- BFH39
- BFH42
- BFH45
- BFH48

RD	AD	FI	ND	AE	IA	BD	AA
Ⓢ	⊗	Ⓢ	Ⓢ	Ⓢ	Ⓢ	⊗	Ⓢ

Two doors, one half-depth adjustable shelf

BASE FULL HEIGHT, BI-PARTING

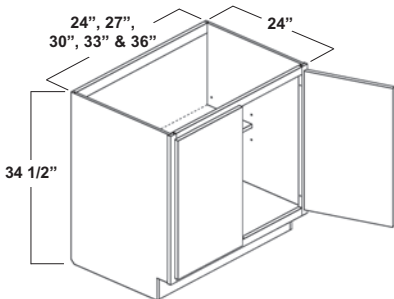

- BFH24BP
- BFH27BP
- BFH30BP
- BFH33BP
- BFH36BP

RD	AD	FI	ND	AE	IA	BD	AA
Ⓢ	⊗	Ⓢ	Ⓢ	Ⓢ	Ⓢ	Ⓢ	Ⓢ

Two doors, one half-depth adjustable shelf
No center stile, 1/8" reveal between doors

PANTRY BASES

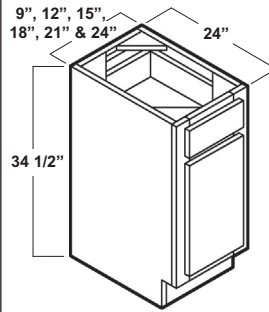

- PB9
- PB12
- PB15
- PB18
- PB21
- PB24

RD	AD	FI	ND	AE	IA	BD	AA
Ⓢ	⊗	Ⓢ	Ⓢ	Ⓢ	Ⓢ	Ⓢ	Ⓢ

One door, one drawer, one half-depth adjustable shelf
Add FX before Item Code for Drawer Upgrade
For front only, order BSF

PANTRY BASES

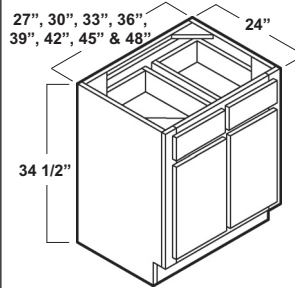

- PB27
- PB30
- PB33
- PB36
- PB39
- PB42
- PB45
- PB48

RD	AD	FI	ND	AE	IA	BD	AA
Ⓢ	⊗	Ⓢ	Ⓢ	Ⓢ	Ⓢ	Ⓢ	Ⓢ

Two doors, two drawers, one half-depth adjustable shelf
Add FX before Item Code for Drawer Upgrade
For front only, order BSF

PANTRY BASES, BI-PARTING

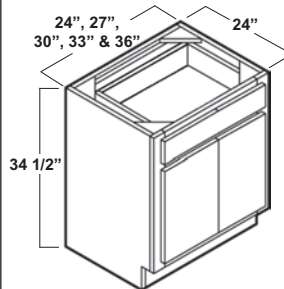

- PB24BP
- PB27BP
- PB30BP
- PB33BP
- PB36BP

RD	AD	FI	ND	AE	IA	BD	AA
Ⓢ	⊗	Ⓢ	Ⓢ	Ⓢ	Ⓢ	Ⓢ	Ⓢ

Two doors, one drawer, one half-depth adjustable shelf
No center stile, 1/8" reveal between doors
Add FX before Item Code for Drawer Upgrade

BURNER SINK BASE

BSB24

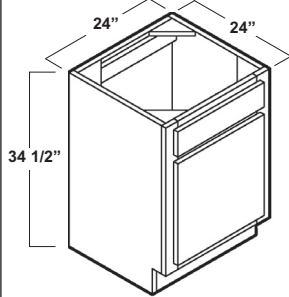

RD	AD	FI	ND	AE	IA	BD	AA
\$	⊗	\$	\$	\$	\$	⊗	\$

One door, no shelves
 One false front
 For front only, order BSF

BURNER SINK BASES

BSB27

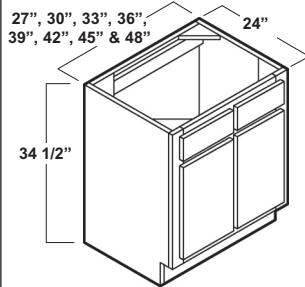

RD	AD	FI	ND	AE	IA	BD	AA
\$	⊗	\$	\$	\$	\$	⊗	\$

Two doors, no shelves
 Two false fronts
 For front only, order BSF

BSB30

BSB33

BSB36

BSB39

BSB42

BSB45

BSB48

BURNER SINK BASES, BI-PARTING

BSB24BP

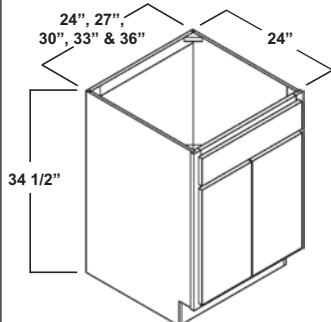

RD	AD	FI	ND	AE	IA	BD	AA
\$	⊗	\$	\$	\$	\$	⊗	\$

Two doors, one false front, no shelves
 No center stile, 1/8" reveal between doors

BSB27BP

BSB30BP

BSB33BP

BSB36BP

FARM SINK BASES

FSB30

FSB33

FSB36

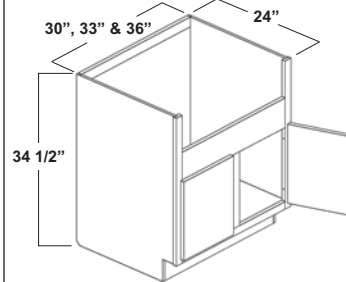

RD	AD	FI	ND	AE	IA	BD	AA
\$	⊗	\$	\$	\$	⊗	⊗	⊗

Two doors, no shelf
 Measurements A = 12" for 30", 13-1/2" for 33", 15" for 36"
 Measurements B = 7-1/2", C = 6", D = 15"

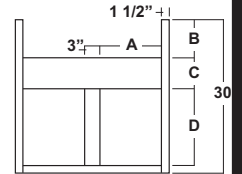

4 1/2" TOEKICK
 *See p. 0.36 for additional measurements

FARM SINK BASES, BI-PARTING

FSB30BP

FSB33BP

FSB36BP

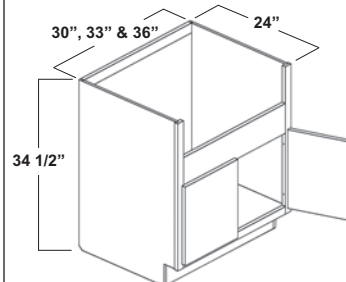

RD	AD	FI	ND	AE	IA	BD	AA
\$	⊗	\$	\$	\$	⊗	⊗	⊗

Two doors, no shelf
 No center stile, 1/8" reveal between doors
 From chart above, measurements B = 7-1/2", C = 6", D = 15"

- Standard
- Ⓢ Available with an Upcharge
- △ Available with Exceptions
- ⊗ Not Available

Refer to pages 0.21-0.22 for Door and Finish Availability Chart

OPTIONS

- RD Reduce Depth
- AE Applied Overlay Ends
- AD Add Depth
- IA Installed Accessories
- FI Finished Interior
- BD Bottom Drawers
- ND No Doors/No Drawers
- AA ADA Adaptable

MICROWAVE BASES

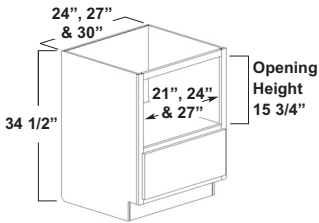

- MWB24**
- MWB27**
- MWB30**

RD	AD	FI	ND	AE	IA	BD	AA
Ⓢ	⊗	●	⊗	Ⓢ	⊗	⊗	Ⓢ

Comes with finished interior

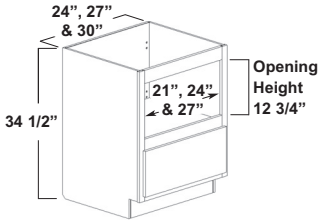

- MWBTRM24**
- MWBTRM27**
- MWBTRM30**

RD	AD	FI	ND	AE	IA	BD	AA
Ⓢ	⊗	⊗	⊗	Ⓢ	⊗	⊗	Ⓢ

Top and bottom rails are 3" trimmable
Ledge support shipped with MWBTRMs — shipped unattached

PANTRY SINK BASE

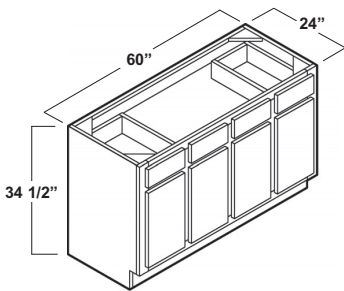

SSB60

RD	AD	FI	ND	AE	IA	BD	AA
Ⓢ	⊗	Ⓢ	Ⓢ	Ⓢ	⊗	⊗	Ⓢ

Four doors, two drawers
Two false fronts in middle, no shelves
Add FX before Item Code for Drawer Upgrade

DRAWER BASES - 4 DRAWER

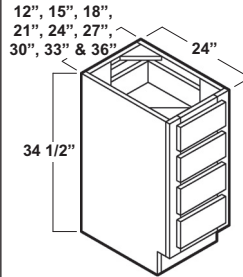

- D4B12**
- D4B15**
- D4B18**
- D4B21**
- D4B24**
- D4B27**
- D4B30**
- D4B33**
- D4B36**

RD	AD	FI	ND	AE	IA	BD	AA
Ⓢ	⊗	⊗	Ⓢ	Ⓢ	⊗	⊗	Ⓢ

Four drawers
Two shallow height drawers, two deep drawers
Add FX before Item Code for Drawer Upgrade

DRAWER BASES - 3 DRAWER

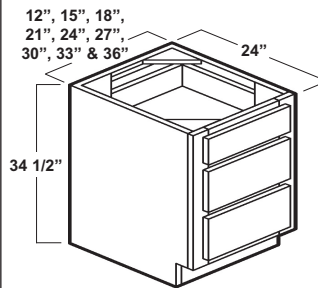

- D3B12**
- D3B15**
- D3B18**
- D3B21**
- D3B24**
- D3B27**
- D3B30**
- D3B33**
- D3B36**

RD	AD	FI	ND	AE	IA	BD	AA
Ⓢ	⊗	⊗	Ⓢ	Ⓢ	⊗	⊗	Ⓢ

Three drawers
One shallow height drawer, two deep drawers
Add FX before Item Code for Drawer Upgrade

DRAWER BASES - 2 DRAWER

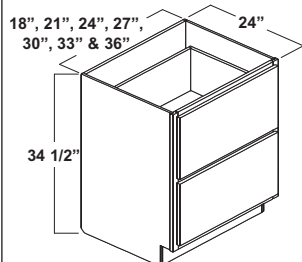

RD	AD	FI	ND	AE	IA	BD	AA
S	⊗	⊗	S	S	⊗	⊗	S

Two deep drawers
 This cabinet only available in FX upgrade

- D2B18
- D2B21
- D2B24
- D2B27
- D2B30
- D2B33
- D2B36

DIAGONAL SINK BASE

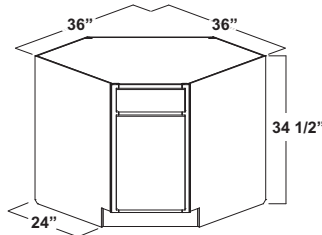

DSB36

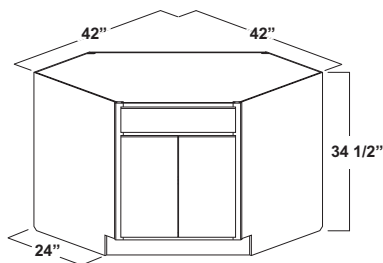

DSB42BP

RD	AD	FI	ND	AE	IA	BD	AA
⊗	⊗	⊗	⊗	⊗	⊗	⊗	⊗

No shelves

- Standard
- Ⓢ Available with an Upcharge
- ⚠ Available with Exceptions
- ⊗ Not Available

Refer to pages 0.21-0.22 for Door and Finish Availability Chart

OPTIONS

- RD Reduce Depth
- AE Applied Overlay Ends
- AD Add Depth
- IA Installed Accessories
- FI Finished Interior
- BD Bottom Drawers
- ND No Doors/No Drawers
- AA ADA Adaptable

PANTRY BASE CORNER

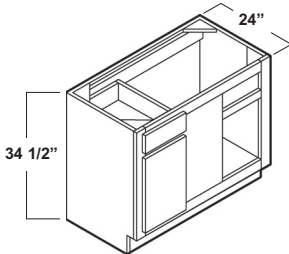

- RPBC36
- RPBC39
- RPBC42
- RPBC45
- RPBC48

RD	AD	FI	ND	AE	IA	BD	AA
Ⓢ	⊗	⊗	Ⓢ	Ⓢ	Ⓢ	⊗	Ⓢ

For corner base cabinets, the side with the opening determines RH or LH
 1-1/2" blind exposed
 Add FX before Item Code for Drawer Upgrade
 Includes half-depth shelf
 Note: Filler & panel not included

BASES

Cabinet	Actual Width	Center Stile Width	Min. Install Distance	Min. Center Stile Exposure	Min. Total Space Filled	Max. Install Distance	Max. Center Stile Exposure	Max. Total Space Filled	Cabinet Equivalent
			SOL / FOL	SOL / FOL	SOL / FOL		SOL / FOL		
RPBC 36 *	27"	6"	9" / 10"	1" / 1-3/16"	36" / 37"	12"	4" / 3-3/16"	39"	PB12
RPBC 39	30"	9"	6" / 7"	1" / 1-3/16"	36" / 37"	12"	7" / 6-3/16"	42"	PB12
RPBC 42	36"	9"	3" / 4"	1" / 1-3/16"	39" / 40"	9"	7" / 6-3/16"	45"	PB15
RPBC 45	42"	9"	0" / 1"	1" / 1-3/16"	42" / 43"	6"	7" / 6-3/16"	48"	PB18
RPBC 48	48"	9"	0" / 0"	4" / 3-3/16"	48" / 48"	3"	7" / 6-3/16"	51"	PB21

SOL = Standard Overlay Cabinet Style
 FOL = Full Overlay Cabinet Style

Note: All Full Overlay Blind Cabinets require an adjacent 3" filler
 A 3" filler for all Standard Overlay Blind Cabinets is recommended

* Due to the nature of Full Overlay construction, these cabinets can only occupy a minimum of 37"
 Cabinet must be pulled 3" for proper clearance

LAZY SUSAN BARREL BASE

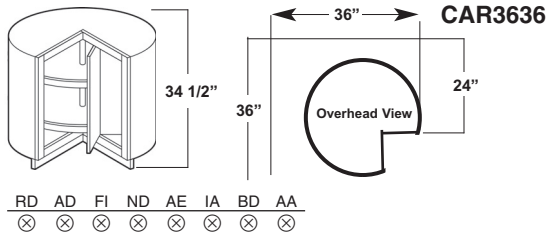

RD	AD	FI	ND	AE	IA	BD	AA
⊗	⊗	⊗	⊗	⊗	⊗	⊗	⊗

Toe Kick is shipped attached
Doors are attached to rotating shelves
Not available in full overlay styles

EASY REACH CORNER BASE

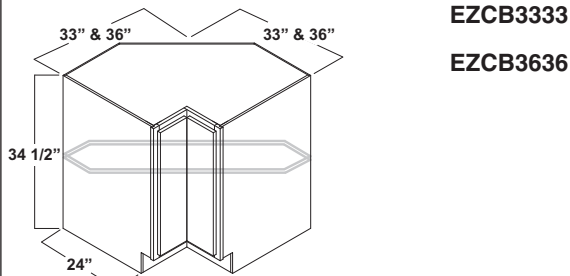

RD	AD	FI	ND	AE	IA	BD	AA
⊗	⊗	⊗	⊗	⊗	⊗	⊗	Ⓢ

One adjustable shelf
Full Overlay requires RH or LH
Hinge side determines hand
165° hinge opening
Full depth shelf

LAZY SUSAN CORNER BASE

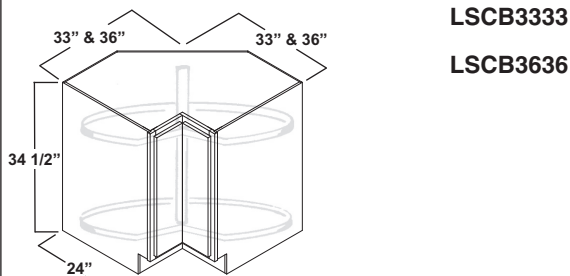

RD	AD	FI	ND	AE	IA	BD	AA
⊗	⊗	⊗	⊗	⊗	⊗	⊗	⊗

Full Overlay requires RH or LH
Hinge side determines hand
165° hinge opening
LSCB has an overlapping door not attached to shelves
Handicap modifications cannot be made on Lazy Susan Corner Bases

SUPER SUSAN CORNER BASE

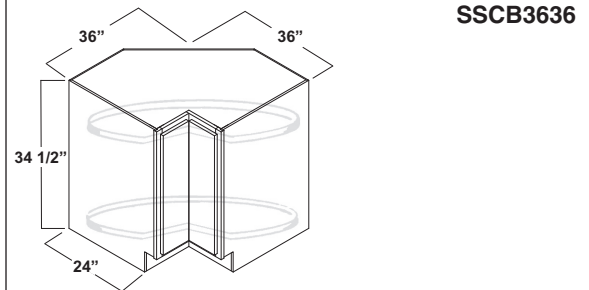

RD	AD	FI	ND	AE	IA	BD	AA
⊗	⊗	⊗	⊗	⊗	⊗	⊗	⊗

Full Overlay requires RH or LH
Hinge side determines hand
165° hinge opening
SSCB has an overlapping door not attached to shelves
Handicap modifications cannot be made on Super Susan Corner Bases
Contains one shelf with 2 wooden rotating units

EASY REACH DIAGONAL CORNER BASE

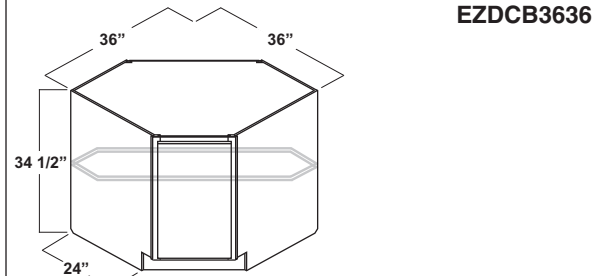

RD	AD	FI	ND	AE	IA	BD	AA
⊗	⊗	⊗	⊗	⊗	⊗	⊗	⊗

One adjustable, full depth shelf

LAZY SUSAN DIAGONAL CORNER BASE

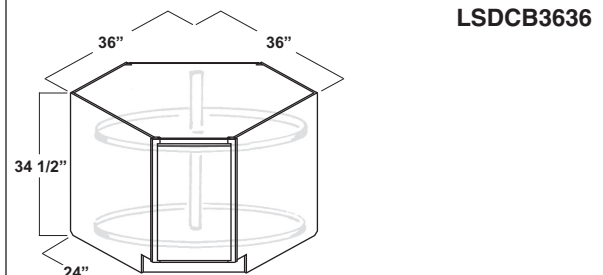

RD	AD	FI	ND	AE	IA	BD	AA
⊗	⊗	⊗	⊗	⊗	⊗	⊗	⊗

Full Overlay requires RH or LH
LSDCB has an overlapping door not attached to shelves
Handicap modifications cannot be made on Lazy Susan Corner Bases

- Standard
- Ⓢ Available with an Upcharge
- ⚠ Available with Exceptions
- ⊗ Not Available

Refer to pages 0.21-0.22 for Door and Finish Availability Chart

OPTIONS

- RD Reduce Depth
- AE Applied Overlay Ends
- AD Add Depth
- IA Installed Accessories
- FI Finished Interior
- BD Bottom Drawers
- ND No Doors/No Drawers
- AA ADA Adaptable

SUPER SUSAN DIAGONAL CORNER BASE

SSDCB3636

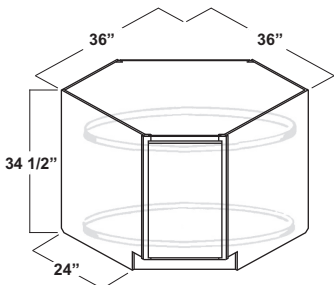

RD	AD	FI	ND	AE	IA	BD	AA
⊗	⊗	⊗	⊗	⊗	⊗	⊗	⊗

Contains one shelf with 2 wooden rotating units

BASE END CABINET

BEC24

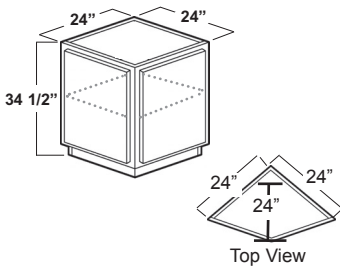

RD	AD	FI	ND	AE	IA	BD	AA
⊗	⊗	Ⓢ	Ⓢ	⊗	⊗	⊗	Ⓢ

Two doors, one adjustable shelf

BASE TRANSITIONAL CABINET

BTC12LH

BTC12RH

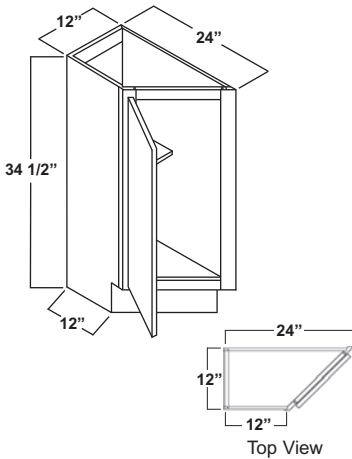

RD	AD	FI	ND	AE	IA	BD	AA
⊗	⊗	Ⓢ	Ⓢ	Ⓢ	⊗	⊗	Ⓢ

One door, one shelf
The left or right hand is determined by which side the short end is located
LH shown

ISLAND BASE

IB24

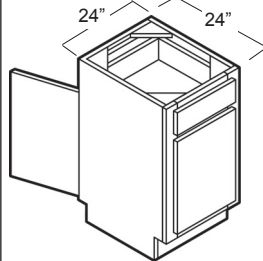

RD	AD	FI	ND	AE	IA	BD	AA
Ⓢ	⊗	Ⓢ	Ⓢ	Ⓢ	⊗	Ⓢ	⊗

One door each side
One drawer and one door on one side, one false drawer front and one door on other side, one full-depth shelf
Add FX before Item Code for Drawer Upgrade

ISLAND BASES

IB30

IB36

IB48

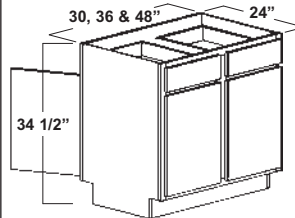

RD	AD	FI	ND	AE	IA	BD	AA
Ⓢ	⊗	Ⓢ	Ⓢ	Ⓢ	⊗	Ⓢ	⊗

Two doors each side
Two drawers and two doors on one side, two doors and two false drawer fronts on other side, one full-depth shelf
Add FX before Item Code for Drawer Upgrade

ISLAND BASES, BI-PARTING

IB24BP

IB30BP

IB36BP

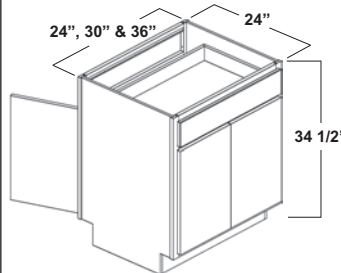

RD	AD	FI	ND	AE	IA	BD	AA
Ⓢ	⊗	Ⓢ	Ⓢ	Ⓢ	⊗	Ⓢ	⊗

Two doors each side, one drawer
One false front, one full-depth shelf

ISLAND FULL HEIGHT

IFH24

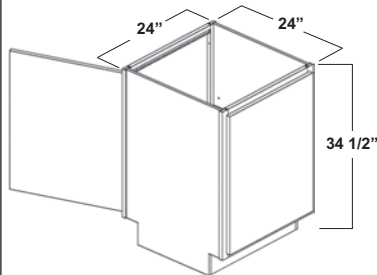

RD	AD	FI	ND	AE	IA	BD	AA
\$	⊗	\$	\$	\$	⊗	⊗	⊗

One door each side, one full-depth shelf

ISLAND SINK BASE

ISB24

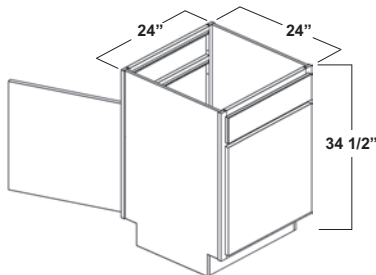

RD	AD	FI	ND	AE	IA	BD	AA
\$	⊗	\$	\$	\$	⊗	⊗	⊗

One door each side, two false fronts
No shelf

ISLAND FULL HEIGHT

IFH30

IFH36

IFH48

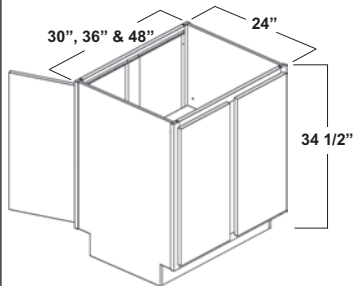

RD	AD	FI	ND	AE	IA	BD	AA
\$	⊗	\$	\$	\$	⊗	⊗	⊗

Two doors each side, one full-depth shelf

ISLAND SINK BASES

ISB30

ISB36

ISB48

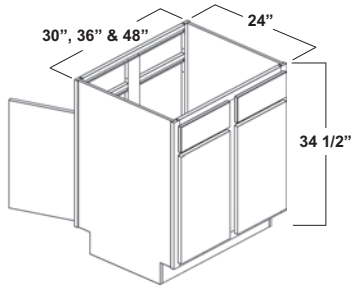

RD	AD	FI	ND	AE	IA	BD	AA
\$	⊗	\$	\$	\$	⊗	⊗	⊗

Two doors and two false fronts each side
No shelf

ISLAND FULL HEIGHT, BI-PARTING

IFH24BP

IFH30BP

IFH36BP

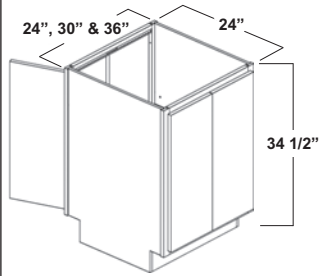

RD	AD	FI	ND	AE	IA	BD	AA
\$	⊗	\$	\$	\$	⊗	⊗	⊗

Two doors each side, one full-depth shelf
No center stile, 1/8" reveal between doors

ISLAND SINK BASES, BI-PARTING

ISB24BP

ISB30BP

ISB36BP

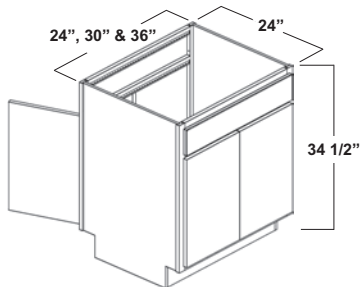

RD	AD	FI	ND	AE	IA	BD	AA
\$	⊗	\$	\$	\$	⊗	⊗	⊗

Two doors each side, one false front each side
No center stile, 1/8" reveal between doors
No shelf

- Standard
- Ⓢ Available with an Upcharge
- ⚠ Available with Exceptions
- ⊗ Not Available

Refer to pages 0.21-0.22 for Door and Finish Availability Chart

OPTIONS

- | | |
|-------------------------------|---------------------------------|
| RD Reduce Depth | AE Applied Overlay Ends |
| AD Add Depth | IA Installed Accessories |
| FI Finished Interior | BD Bottom Drawers |
| ND No Doors/No Drawers | AA ADA Adaptable |

CORNER SINK FRONTS

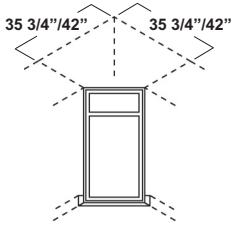

For 35-3/4" **CSF165**

For 42" **CSF255**

Toe plates shipped loose

Sink front ends are recommended on both sides of the CSF's

BASE SINK FRONTS

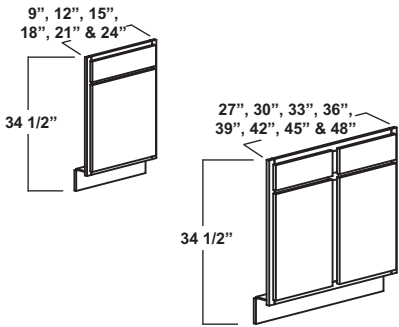

BSF9

BSF12

BSF15

BSF18

BSF21

BSF24

BSF27

BSF30

BSF33

BSF36

BSF39

BSF42

BSF45

BSF48

Toe plates shipped loose

SINK FRONT FLOORS

Not shown 48" x 24" **SFF4824**

42" x 42" **SFF4242**

1/2" particleboard with natural maple laminate on one side

SFF4824 - For use with BSF or VLF

SFF4242 - For use with CSF

Cherry upcharge not applicable to SFF's

STANDARD ROLL OUT TRAYS

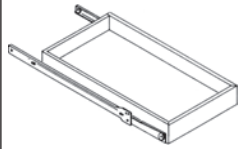

- Order RTU same size as cabinet
- **Standard two drawer cabinets require one pair**
- **Bi-parting cabinets use one full-width tray**
- 30", 33" and 36" bi-parting are only available in wood
- 45" available in wood only
- Standard RTU is 7mil miter-fold vinyl tray with 3-5/8" sides
- Available in natural Maple for wood lines and white for white lines
- **Designed for 24" cabinets only; will not fit vanity cabinets**
- Pilasters are 20" tall and sit 1/4" from bottom of cabinet
- Accommodates 3 roll outs max per pilaster
- If 4 trays needed, order 2 SGL's and 2 EXT's
- SGL's come with pilasters and drawer guides system
- EXT's are trays only and do not come with pilaster
- 50 lb. capacity per tray
- **Not available with Full Extension guide**
- Hinge on modified handicap cabinet must be changed to accommodate RTU

Singles are used for single door base cabinets and BP bases.

RTU12SGL
RTU15SGL
RTU18SGL
RTU21SGL
RTU24SGL
RTU27BPSGL

Pairs are used for double door cabinets with center stile.

RTU27PR
RTU30PR
RTU33PR
RTU36PR
RTU39PR
RTU42PR
RTU48PR

Extra trays do not come with hardware designed as add-ons to existing systems.

RTU12EXT
RTU15EXT
RTU18EXT
RTU21EXT
RTU24EXT
RTU27BPEXT
RTU27EXT
RTU30EXT
RTU33EXT
RTU36EXT
RTU39EXT
RTU42EXT
RTU48EXT

Trays for blind base cabinets

RTU36/39EXT
RTU36/39SGL
RTU39/42EXT
RTU39/42SGL
RTU42/45EXT
RTU42/45SGL
RTU45/48EXT
RTU45/48SGL
RTU48/51EXT
RTU48/51SGL

WOOD ROLL OUT TRAYS

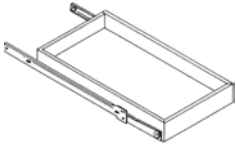

- Order RTU same size as cabinet
- **Standard two drawer cabinets require one pair**
- **Bi-parting cabinets use one full-width tray**
- Wood RTU is a maple tray with 2-1/2" sides
- Available in natural Maple for wood lines
- **Designed for 24" cabinets only; will not fit vanity cabinets**
- Pilasters are 20" tall and sit 1/4" from bottom of cabinet
- Accommodates 3 roll outs max per pilaster
- If 4 trays needed, order 2 SGL's and 2 EXT's
- SGL's come with pilasters and drawer guides system
- EXT's are trays only and do not come with pilaster
- 50 lb. capacity per tray
- **Not available with Full Extension guide**
- Hinge on modified handicap cabinet must be changed to accommodate RTU

Singles are used for single door base cabinets and BP bases.

WDRTU12SGL
WDRTU15SGL
WDRTU18SGL
WDRTU21SGL
WDRTU24SGL
WDRTU27BPSGL
WDRTU30BPSGL
WDRTU33BPSGL
WDRTU36BPSGL

Pairs are used for double door cabinets with center stile.

WDRTU27PR
WDRTU30PR
WDRTU33PR
WDRTU36PR
WDRTU39PR
WDRTU42PR
WDRTU45PR
WDRTU48PR

Extra trays do not come with hardware designed as add-ons to existing systems.

WDRTU12EXT
WDRTU15EXT
WDRTU18EXT
WDRTU21EXT
WDRTU24EXT
WDRTU27BPEXT
WDRTU27EXT
WDRTU30BPEXT
WDRTU30EXT
WDRTU33EXT
WDRTU33BPEXT
WDRTU36BPEXT
WDRTU36EXT
WDRTU39EXT
WDRTU42EXT
WDRTU45EXT
WDRTU48EXT

Trays for blind base cabinets

WDRTU36/39EXT
WDRTU36/39SGL
WDRTU39/42EXT
WDRTU39/42SGL
WDRTU42/45EXT
WDRTU42/45SGL
WDRTU45/48EXT
WDRTU45/48SGL
WDRTU48/51EXT
WDRTU48/51SGL

**SINGLE WASTE BASKET
FOR 24" DEEP BASE**

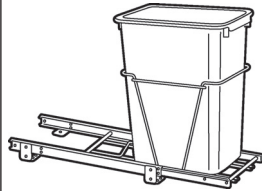

SWB

Minimum Cabinet Opening	
Width	10 1/2"
Depth	22 1/2"
Height	19 1/2"

36 Qt
Order a DMK if needed
Designed to fit in 15" base

**DOUBLE WASTE BASKET
FOR 24" DEEP BASE**

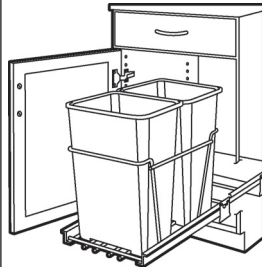

DWB

Minimum Cabinet Opening	
Width	11 1/2"
Depth	22 1/2"
Height	19 1/2"

27 Qt per container
Designed to fit in 15" base

**DOOR MOUNTING KIT
FOR 24" DEEP BASE**

Drawing not shown

DMK

Will not work on doors wider than 15" because of installation

35 QT SINGLE WASTE BIN

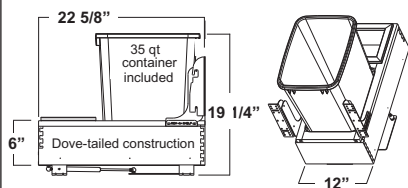

WDSWB35

Minimum Cabinet Opening	
Width	11.38
Depth	22.75
Height	19.38

Full Extension
Will not work in PB27; opening is too small
All mounting hardware and DMK included
Features Soft Close
Designed to fit in 15" base

35 QT DOUBLE WASTE BIN

WDDWB35

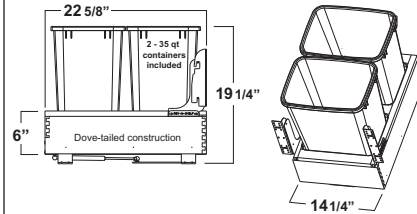

Minimum Cabinet Opening	
Width	14.38
Depth	22.75
Height	19.38

Full Extension
Will not work in all cabinet sizes; verify cabinet opening before ordering
All mounting hardware and DMK included
Features Soft Close
Designed to fit in 18" base

50 QT DOUBLE WASTE BIN

WDDWB50

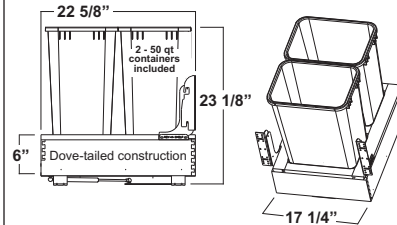

Minimum Cabinet Opening	
Width	17.38
Depth	22.75
Height	23.28

Full Extension
All mounting hardware and DMK included
Features Soft Close
Will only work in BFH cabinets
Designed for use in BFH21

BASE FILLER PULLOUT ORGANIZER

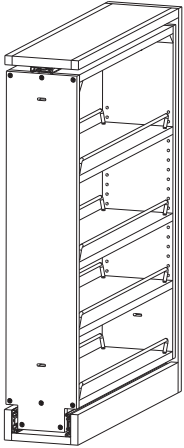

BFPO3
 3" wide, 30" high
 1 fixed shelf,
 3 adjustable shelves
 Shelf is 1 3/4" wide

BFPO6
 6" wide, 30" high
 1 fixed shelf,
 3 adjustable shelves
 Shelf is 4 3/4" wide

Base filler applied to front of organizer (order separately)
 Designed to install between cabinets

BASE PULLOUT ORGANIZER

BPO5
 5" wide, 25 1/2" high
 1 fixed shelf,
 3 adjustable shelves

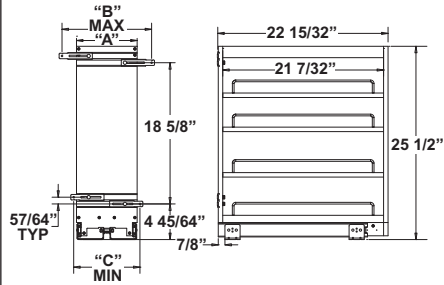

Base Cabinet Pullout Organizer				
Item	Description	Dim "A"	Dim "B"	Dim "C"
BPO5	5" Base Pullout Organizer	5"	8 13/16"	5 3/4"

Designed to install inside BFH9

BPO8
 8" wide, 25 1/2" high
 1 fixed shelf,
 3 adjustable shelves

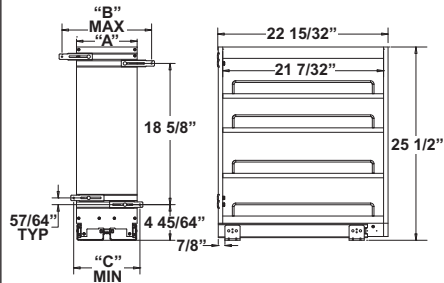

Base Cabinet Pullout Organizer				
Item	Description	Dim "A"	Dim "B"	Dim "C"
BPO8	8" Base Pullout Organizer	8"	11 13/16"	8 3/4"

Designed to install inside BFH12

DRAWER INSERT ACCESSORIES

14" Wood Cutlery Tray
For use in 15" and 18" cabinets

WDCT14

20" Wood Cutlery Tray
For use in 21" and 24" cabinets

WDCT20

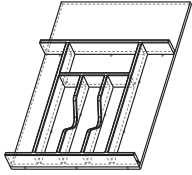

18" Wood Utility Tray
For use in 12", 18", 21", and 24" cabinets

WDUT18

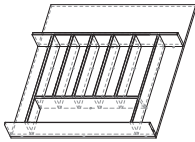

18" Spice Drawer Insert
For use in 18" and 21" cabinets
*Accommodates certain sizes of bottles

WDS18

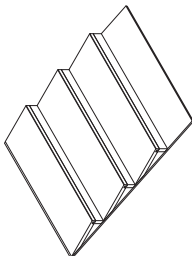

CORNER PULLOUT ORGANIZERS

Blind Corner Pullout Organizer

BCPO4851

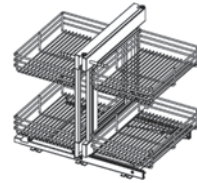

LeMans Corner Pullout - R (Right Pull)

LBCP4851R

LeMans Corner Pullout - L (Left Pull)

LBCP4851L

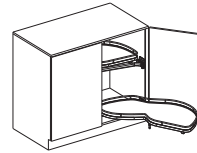

Will only work in RPBC48
See drawing and chart below
NOTE: LBCP4851R fits in RPBC48L
LBCP4851L fits in RPB48R

Framed Cabinet

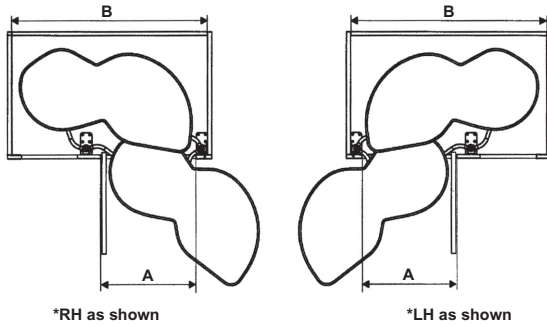

Model/Tray Shape	Framed A min.	B min.
	450 mm (17 3/4")	820 mm (36 1/4")



NOTES

Tall Cabinets

Construction Options and Modifications

PC - Plywood Construction

FX - Wood Dovetail Drawer with Soft Close Feature

RD - Reduce Depth

AD - Added Depth

ND - No Doors/No Drawers

FI - Finished Interior

AE - Applied Overlay Ends

IA - Installed Accessories

How to read item code:

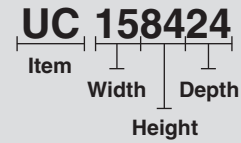

Option Chart Symbols

- Standard
- ☒ Available with an Upcharge
- ⚠ Available with Exceptions
- ⊗ Not Available

Reference Modifications Table on Page 0.27

Features:

- ◆ Cabinet interior is laminate with a natural maple grain pattern. White interior will be used on Fairmont and Alpine cabinets. Note, when ordering Fairmont and Alpine in Plywood, interior will be natural maple unless ordered with Finished Interior.
- ◆ Hinges are fully concealed 6-way adjustable.
- ◆ Right-hand hinging standard on single door cabinets.
- ◆ For Oven Cabinets (OC), standard drawer is 3/4 extension particleboard drawer; plywood is 3/4 extension plywood.
- ◆ Bottom doors will not be Arch door style.
- ◆ Shelves are full depth.
- ◆ Cabinets have unfinished toe kick. A Toe Kick (TK) or Toe Plate (TP) must be ordered to finish.
- ◆ Please refer to Cabinet References (pages 0.09-0.18) for decorative hardware requirements.
- ◆ Specify LH or RH when ordering Arched styles in single door cabinets.
- ◆ Soft Close integrated hinge on Full Overlay lines.

Drawer Upgrade Option:

- ◆ FX: Wood dovetail drawer; Full Extension with Soft Close slide (add/subtract \$92 per drawer to list).
- ◆ FX: Standard in Full Overlay lines; refer to Cabinet References (pages 0.09-0.18)

Options:

Available options are noted beside each cabinet.

- ◆ Depth Change: A reduction in 3" increments with 6" being minimum depth allowable.
- ◆ No Doors: Finished interior is not included standard in this option.
- ◆ Finished Interior: Glazed cabinets will not have a glazed interior.
- ◆ Applied Overlay Ends: Use an Overlay End to flush out an end. This is required when applying a decorative door.
- ◆ Bottom Drawers: Check Options Chart beside cabinet for availability.

- Standard
- Ⓢ Available with an Upcharge
- ⚠ Available with Exceptions
- ⊗ Not Available

Refer to pages 0.21-0.22 for Door and Finish Availability Chart

OPTIONS

- RD Reduce Depth
- AE Applied Overlay Ends
- AD Add Depth
- IA Installed Accessories
- FI Finished Interior
- BD Bottom Drawers
- ND No Doors/No Drawers
- AA ADA Adaptable

Utility Cabinets

12" DEEP, 15" & 18" WIDE

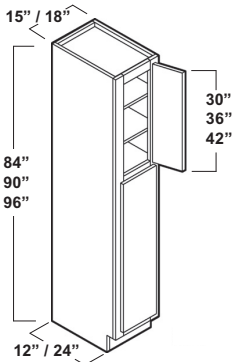

RD	AD	FI	ND	AE	IA	BD	AA
Ⓢ	Ⓢ	Ⓢ	Ⓢ	Ⓢ	Ⓢ	⊗	Ⓢ

One fixed shelf
 96" high shown
 Includes adjustable shelves in upper section:
 84" High — one shelf;
 90" High — one shelf;
 96" High — two shelves
 No center stile
 Order RTU to fit total width of cabinet

- UC158412
- UC159012
- UC159612
- UC188412
- UC189012
- UC189612

24" DEEP, 15" & 18" WIDE

See drawing/options above
 Added depth not available

- UC158424
- UC159024
- UC159624
- UC188424
- UC189024
- UC189624

12" DEEP, 24", 30" & 36" WIDE

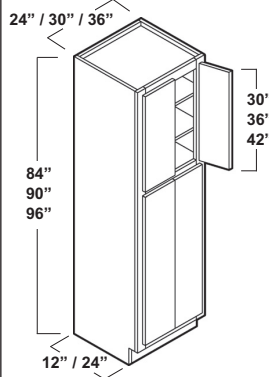

RD	AD	FI	ND	AE	IA	BD	AA
Ⓢ	Ⓢ	Ⓢ	Ⓢ	Ⓢ	Ⓢ	⊗	Ⓢ

One fixed shelf
 96" high shown
 Includes adjustable shelves in upper section:
 84" High — one shelf;
 90" High — one shelf;
 96" High — two shelves
 No center stile
 Order RTU to fit total width of cabinet
 Bi-Parting Utility Cabinets require only one RTU

- UC248412BP
- UC249012BP
- UC249612BP
- UC308412BP
- UC309012BP
- UC309612BP
- UC368412BP
- UC369012BP
- UC369612BP

24" DEEP, 24", 30" & 36" WIDE

See drawing/options above
 Added depth not available

- UC248424BP
- UC249024BP
- UC249624BP
- UC308424BP
- UC309024BP
- UC309624BP
- UC368424BP
- UC369024BP
- UC369624BP

Oven Cabinets

84", 90" & 96" TALL, 24" DEEP

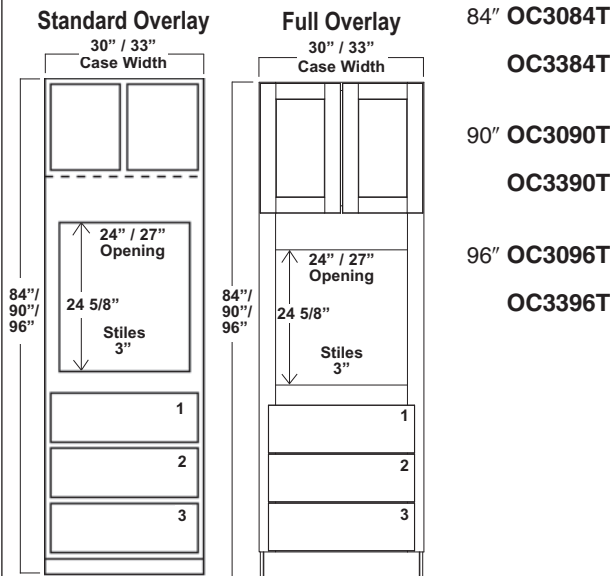

RD	AD	FI	ND	AE	IA	BD	AA
\$	⊗	\$	\$	\$	\$	⊗	\$

Includes adjustable shelves in upper section:
 84" High — no shelf;
 90" High — one shelf;
 96" High — two shelves
 3" stiles
 Ledger support supplied with oven cabinets — shipped unattached
 Check manufacturer specifications for required cutout dimensions
 Add FX before Item Code for Drawer Upgrade

TALL CABINETS

- Standard
- Ⓢ Available with an Upcharge
- ⚠ Available with Exceptions
- ⊗ Not Available

Refer to pages 0.21-0.22 for Door and Finish Availability Chart

OPTIONS

- RD Reduce Depth
- AE Applied Overlay Ends
- AD Add Depth
- IA Installed Accessories
- FI Finished Interior
- BD Bottom Drawers
- ND No Doors/No Drawers
- AA ADA Adaptable

Standard Overlay				Max. Height			
Cabinet Width	Min. Width	Max. Width	Min. Height	With 3 Drawers	One Drawer Removed	Two Drawers Removed	Three Drawers Removed
30"	24"	28"	24-5/8"	35-7/8"	43-3/4"	52-1/2"	60-1/2"
33"	27"	31"	24-5/8"	35-7/8"	43-3/4"	52-1/2"	60-1/2"

Includes adjustable shelves in upper section: 84" high — no shelf; 90" high — one shelf; 96" high — two shelves
 3" stiles
 Ledger support supplied with oven cabinets — shipped unattached
 Check manufacturer's specifications for required cutout dimensions

Full Overlay		With LSOCFP	Max. Height				
Cabinet Width	Min. Width	Max. Width	Min. Height	With 3 Drawers	One Drawer Removed	Two Drawers Removed	Three Drawers Removed
30"	24"	27"	24-5/8"	34-5/8"	43-17/32"	52-7/16"	60"
33"	27"	30"	24-5/8"	34-5/8"	43-17/32"	52-7/16"	60"

Includes adjustable shelves in upper section: 84" high — no shelf; 90" high — one shelf; 96" high — two shelves
 3" stiles
 Ledger support supplied with oven cabinets — shipped unattached
 Check manufacturer's specifications for required cutout dimensions

OVEN CABINET PROFILED FILLER

LSOCFP_

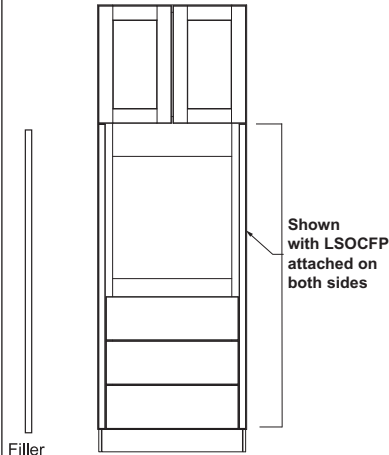

Filler

- 1-5/16" wide
- 3/4" thick
- 61-5/16" high
- 1/8" radius
- May be trimmed
- Filler is purchased separately
- Available in Maple and Cherry only
- Filler sold loose

Profiles Offered



Profile A

SHELF KITS FOR UTILITY CABINETS

- | | |
|---------------------------|-----------------|
| 3 - Shelves with Supports | UC3S1512 |
| 3 - Shelves with Supports | UC3S1524 |
| 3 - Shelves with Supports | UC3S1812 |
| 3 - Shelves with Supports | UC3S1824 |
| 3 - Shelves with Supports | UC3S2412 |
| 3 - Shelves with Supports | UC3S2424 |
| 3 - Shelves with Supports | UC3S3012 |
| 3 - Shelves with Supports | UC3S3024 |
| 3 - Shelves with Supports | UC3S3612 |
| 3 - Shelves with Supports | UC3S3624 |

Each kit contains 3 shelves with supports



NOTES

MARSH CABINETS

Vanity Cabinets

Construction Options and Modifications

PC - Plywood Construction

FX - Wood Dovetail Drawer with Soft Close Feature

RD - Reduce Depth

AD - Added Depth

ND - No Doors/No Drawers

FI - Finished Interior

AE - Applied Overlay Ends

IA - Installed Accessories

BD - Bottom Drawers

How to read item code:



Option Chart Symbols

- Standard
- Ⓢ Available with an Upcharge
- ⚠ Available with Exceptions
- ⊗ Not Available

Reference Modifications Table on Page 0.27

Features:

- ◆ Cabinet interior is laminate with a natural maple grain pattern. White interior will be used on Fairmont and Alpine cabinets. Note, when ordering Fairmont and Alpine in Plywood, interior will be natural maple unless ordered with Finished Interior.
- ◆ Hinges are fully concealed 6-way adjustable.
- ◆ Vanity cabinets are 31-1/2" high standard and 34-1/2" high for Base Height (BH).
- ◆ Right-hand hinging standard on single door cabinets.
- ◆ Arch door styles not available in vanity cabinets.
- ◆ Drawer cabinets with a reduced depth of more than 18" will receive a false drawer front unless upgraded to FX.
- ◆ Standard cabinet has a 3/4 extension, particleboard drawer. Plywood Cabinet (PC) has a 3/4 extension, plywood drawer as standard.
- ◆ Cabinets have unfinished toe kick. A Toe Kick (TK) or Toe Plate (TP) must be ordered to finish.
- ◆ Please refer to Cabinet References (pages 0.09-0.18) for decorative hardware requirements.
- ◆ Soft Close integrated hinge on Full Overlay lines.

Drawer Upgrade Option:

- ◆ FX: Wood dovetail drawer; Full Extension with Soft Close slide (add/subtract \$92 per drawer to list).
- ◆ FX: Can accommodate cabinet depth of 12" deep.
- ◆ FX: Standard in Full Overlay lines.

Options:

Available options are noted beside each cabinet.

- ◆ Depth Change: A reduction in 3" increments with 6" being minimum depth allowable.
- ◆ No Doors: Finished interior is not included standard in this option.
- ◆ Finished Interior: Glazed cabinets will not have a glazed interior.
- ◆ Applied Overlay Ends: Use an Overlay End to flush out an end. This is required when applying a decorative door.
- ◆ Bottom Drawers: Check Options Chart beside cabinet for availability.

- Standard
- Ⓢ Available with an Upcharge
- ⚠ Available with Exceptions
- ⊗ Not Available

Refer to pages 0.21-0.22 for Door and Finish Availability Chart

OPTIONS

- RD Reduce Depth
- AE Applied Overlay Ends
- AD Add Depth
- IA Installed Accessories
- FI Finished Interior
- BD Bottom Drawers
- ND No Doors/No Drawers
- AA ADA Adaptable

21" Deep Vanities

VANITY FULL HEIGHT

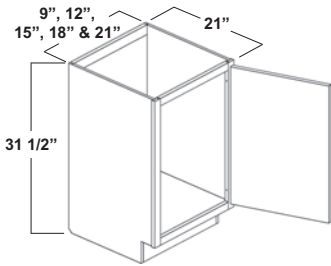

- VFH9
- VFH12
- VFH15
- VFH18
- VFH21

RD	AD	FI	ND	AE	IA	BD	AA
Ⓢ	Ⓢ	Ⓢ	Ⓢ	Ⓢ	⊗	⊗	Ⓢ

One door, no shelves

VANITY FULL HEIGHT, BASE HIGH

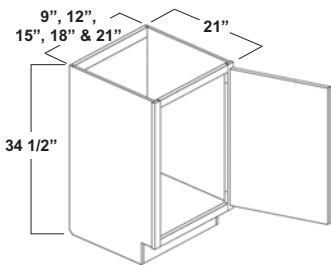

- VFH9BH
- VFH12BH
- VFH15BH
- VFH18BH
- VFH21BH

RD	AD	FI	ND	AE	IA	BD	AA
Ⓢ	⊗	Ⓢ	Ⓢ	Ⓢ	⊗	⊗	Ⓢ

One door, no shelves

VANITY FULL HEIGHT, DOUBLE DOORS

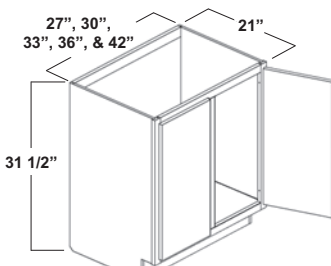

- VFH27
- VFH30
- VFH33
- VFH36
- VFH42

RD	AD	FI	ND	AE	IA	BD	AA
Ⓢ	Ⓢ	Ⓢ	Ⓢ	Ⓢ	⊗	⊗	Ⓢ

Two doors, no shelves
3" center stile

VANITY FULL HEIGHT, DOUBLE DOORS, BASE HIGH

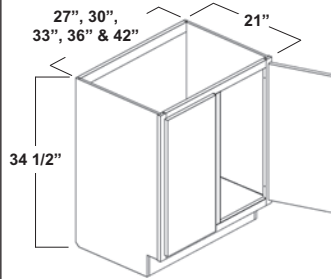

- VFH27BH
- VFH30BH
- VFH33BH
- VFH36BH
- VFH42BH

RD	AD	FI	ND	AE	IA	BD	AA
Ⓢ	⊗	Ⓢ	Ⓢ	Ⓢ	⊗	⊗	Ⓢ

Two doors, no shelves
3" center stile

VANITY FULL HEIGHT, BI-PARTING

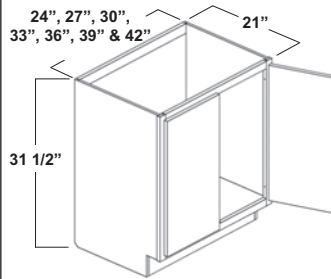

- VFH24BP
- VFH27BP
- VFH30BP
- VFH33BP
- VFH36BP
- VFH39BP
- VFH42BP

RD	AD	FI	ND	AE	IA	BD	AA
Ⓢ	Ⓢ	Ⓢ	Ⓢ	Ⓢ	⊗	⊗	Ⓢ

Two doors, no shelves
No center stile, 1/8" reveal between doors

VANITY FULL HEIGHT, BI-PARTING BASE HIGH

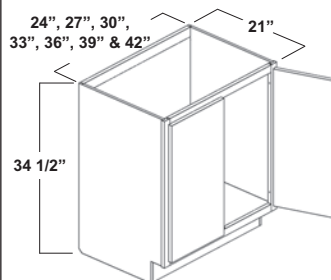

- VFH24BPBH
- VFH27BPBH
- VFH30BPBH
- VFH33BPBH
- VFH36BPBH
- VFH39BPBH
- VFH42BPBH

RD	AD	FI	ND	AE	IA	BD	AA
Ⓢ	⊗	Ⓢ	Ⓢ	Ⓢ	⊗	⊗	Ⓢ

Two doors, no shelves
No center stile, 1/8" reveal between doors

VANITY FULL HEIGHT, BI-PARTING

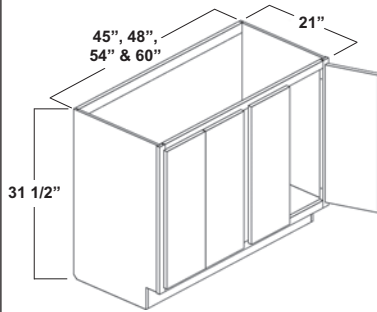

- VFH45BP
- VFH48BP
- VFH54BP
- VFH60BP

RD	AD	FI	ND	AE	IA	BD	AA
\$	\$	\$	\$	\$	⊗	⊗	\$

Four doors, no shelves
No center stile, 1/8" reveal between doors

VANITY FULL HEIGHT, BI-PARTING BASE HIGH

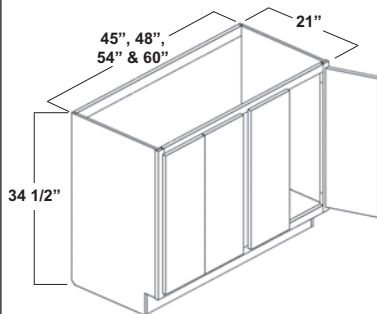

- VFH45BPBH
- VFH48BPBH
- VFH54BPBH
- VFH60BPBH

RD	AD	FI	ND	AE	IA	BD	AA
\$	\$	\$	\$	\$	⊗	⊗	\$

Four doors, no shelves
No center stile, 1/8" reveal between doors

VANITY FULL HEIGHT

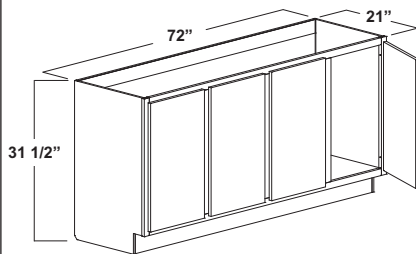

VFH72

RD	AD	FI	ND	AE	IA	BD	AA
\$	\$	\$	\$	\$	⊗	⊗	\$

Four doors, no shelves
3" center stile

VANITY FULL HEIGHT, BASE HIGH

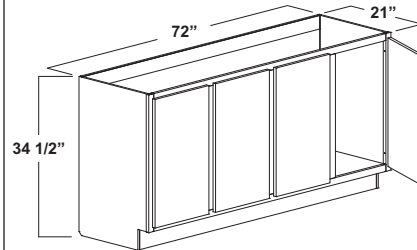

VFH72BH

RD	AD	FI	ND	AE	IA	BD	AA
\$	\$	\$	\$	\$	⊗	⊗	\$

Four doors, no shelves
3" center stile

16" & 18" Deep Vanities

VANITY FULL HEIGHT, 18" & 16" DEEP

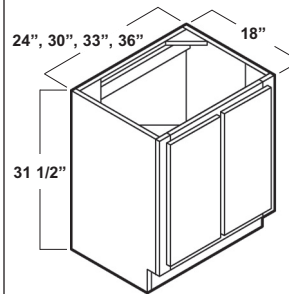

- VFH2418
- VFH3018
- VFH3318
- VFH3618

RD	AD	FI	ND	AE	IA	BD	AA
\$	\$	\$	\$	\$	⊗	⊗	\$

Two full-height doors, no drawers, no shelves
VFH2418 has bi-parting doors

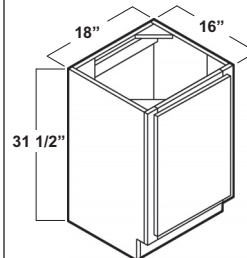

VFH1816

RD	AD	FI	ND	AE	IA	BD	AA
⊗	\$	\$	\$	\$	⊗	⊗	\$

One door, no shelves
Hinged RH (door reversible)

- Standard
- Ⓢ Available with an Upcharge
- ⚠ Available with Exceptions
- ⊗ Not Available

Refer to pages 0.21-0.22 for Door and Finish Availability Chart

OPTIONS

- RD Reduce Depth
- AE Applied Overlay Ends
- AD Add Depth
- IA Installed Accessories
- FI Finished Interior
- BD Bottom Drawers
- ND No Doors/No Drawers
- AA ADA Adaptable

21" Deep Vanities

VANITY SINK

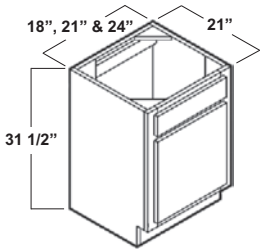

- VS18
- VS21
- VS24

RD	AD	FI	ND	AE	IA	BD	AA
Ⓢ	Ⓢ	Ⓢ	Ⓢ	Ⓢ	⊗	⊗	Ⓢ

One door, one false front
No shelves

VANITY SINK, BASE HIGH

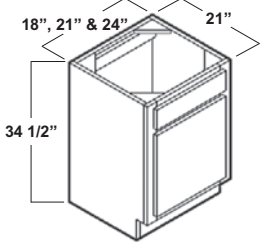

- VS18BH
- VS21BH
- VS24BH

RD	AD	FI	ND	AE	IA	BD	AA
Ⓢ	Ⓢ	Ⓢ	Ⓢ	Ⓢ	⊗	⊗	Ⓢ

One door, one false front
No shelves
For Fronts Only, order BSF in size desired

VANITY SINK

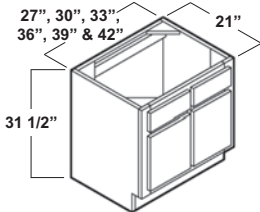

- VS27
- VS30
- VS33
- VS36
- VS39
- VS42

RD	AD	FI	ND	AE	IA	BD	AA
Ⓢ	Ⓢ	Ⓢ	Ⓢ	Ⓢ	⊗	⊗	Ⓢ

Two doors, two false fronts
No shelves

VANITY SINK, BASE HIGH

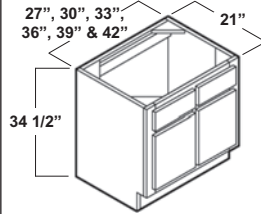

- VS27BH
- VS30BH
- VS33BH
- VS36BH
- VS39BH
- VS42BH

RD	AD	FI	ND	AE	IA	BD	AA
Ⓢ	⊗	Ⓢ	Ⓢ	Ⓢ	⊗	⊗	Ⓢ

Two doors, two false fronts
No shelves
For Fronts Only, order BSF in size desired

VANITY SINK, BI-PARTING

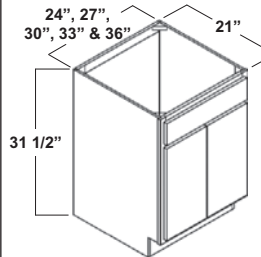

- VS24BP
- VS27BP
- VS30BP
- VS33BP
- VS36BP

RD	AD	FI	ND	AE	IA	BD	AA
Ⓢ	Ⓢ	Ⓢ	Ⓢ	Ⓢ	⊗	⊗	Ⓢ

Two doors, one false front
No center stile, 1/8" reveal between doors
No shelves

VANITY SINK, BI-PARTING BASE HIGH

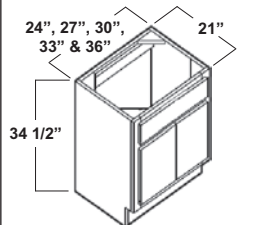

- VS24BPBH
- VS27BPBH
- VS30BPBH
- VS33BPBH
- VS36BPBH

RD	AD	FI	ND	AE	IA	BD	AA
Ⓢ	⊗	Ⓢ	Ⓢ	Ⓢ	⊗	⊗	Ⓢ

Two doors, one false front
No center stile, 1/8" reveal between doors
No shelves

VANITY SINK, BI-PARTING

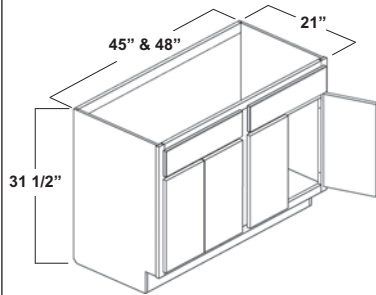

VS45BP
VS48BP

RD	AD	FI	ND	AE	IA	BD	AA
\$	\$	\$	\$	\$	⊗	⊗	\$

Four doors, two false fronts
No center stile, 1/8" reveal between doors
No shelves

VANITY SINK, BI-PARTING BASE HIGH

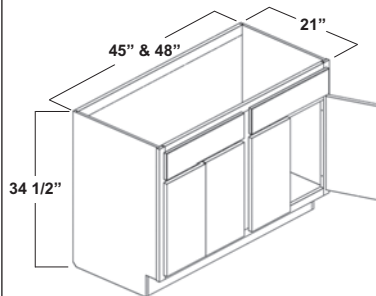

VS45BPBH
VS48BPBH

RD	AD	FI	ND	AE	IA	BD	AA
\$	\$	\$	\$	\$	⊗	⊗	\$

Four doors, two false fronts
No center stile, 1/8" reveal between doors
No shelves

VANITY BASES

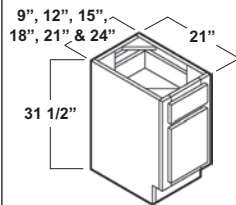

VB9
VB12
VB15
VB18
VB21
VB24

RD	AD	FI	ND	AE	IA	BD	AA
\$	\$	\$	\$	\$	⊗	\$	\$

One door, one drawer
No shelves
All hinged RH (door reversible)
Add FX before Item Code for Drawer Upgrade

VANITY BASES, BASE HIGH

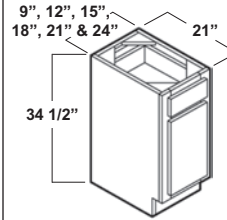

VB9BH
VB12BH
VB15BH
VB18BH
VB21BH
VB24BH

RD	AD	FI	ND	AE	IA	BD	AA
\$	⊗	\$	\$	\$	⊗	\$	\$

One door, one drawer
No shelves
All hinged RH (door reversible)
Add FX before Item Code for Drawer Upgrade
For Fronts Only, order BSF in size desired

VANITY BASES

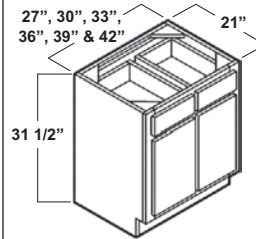

VB27
VB30
VB33
VB36
VB39
VB42

RD	AD	FI	ND	AE	IA	BD	AA
\$	\$	\$	\$	\$	⊗	\$	\$

Two doors, two drawers
No shelves

VANITY BASES, BASE HIGH

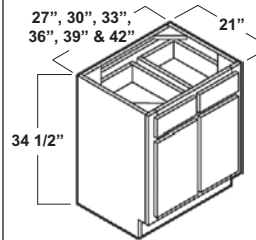

VB27BH
VB30BH
VB33BH
VB36BH
VB39BH
VB42BH

RD	AD	FI	ND	AE	IA	BD	AA
\$	⊗	\$	\$	\$	⊗	\$	\$

Two doors, two drawers
No shelves
For Fronts Only, order BSF in size desired

- Standard
- Ⓢ Available with an Upcharge
- ⚠ Available with Exceptions
- ⊗ Not Available

Refer to pages 0.21-0.22 for Door and Finish Availability Chart

OPTIONS

- RD Reduce Depth
- AE Applied Overlay Ends
- AD Add Depth
- IA Installed Accessories
- FI Finished Interior
- BD Bottom Drawers
- ND No Doors/No Drawers
- AA ADA Adaptable

VANITY BASES, BI-PARTING

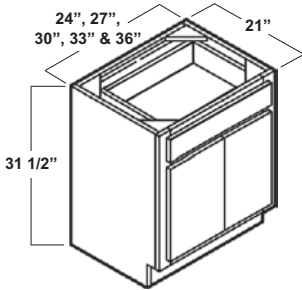

- VB24BP
- VB27BP
- VB30BP
- VB33BP
- VB36BP

RD	AD	FI	ND	AE	IA	BD	AA
Ⓢ	Ⓢ	Ⓢ	Ⓢ	Ⓢ	⊗	Ⓢ	Ⓢ

Two doors, one drawer
No center stile, 1/8" reveal between doors
No shelves

VANITY BASES, BI-PARTING BASE HIGH

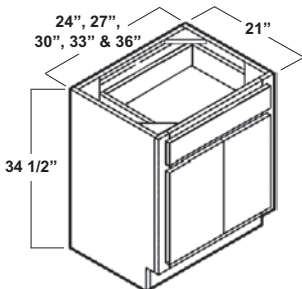

- VB24BPBH
- VB27BPBH
- VB30BPBH
- VB33BPBH
- VB36BPBH

RD	AD	FI	ND	AE	IA	BD	AA
Ⓢ	⊗	Ⓢ	Ⓢ	Ⓢ	⊗	Ⓢ	Ⓢ

Two doors, one drawer
No center stile, 1/8" reveal between doors
No shelves

VANITY BASES, BI-PARTING

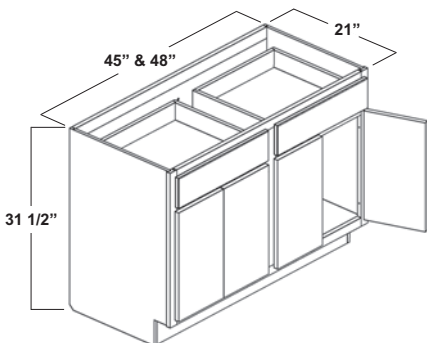

- VB45BP
- VB48BP

RD	AD	FI	ND	AE	IA	BD	AA
Ⓢ	Ⓢ	Ⓢ	Ⓢ	Ⓢ	⊗	Ⓢ	Ⓢ

Four doors, two drawers
No center stile, 1/8" reveal between doors
No shelves

VANITY BASES, BI-PARTING BASE HIGH

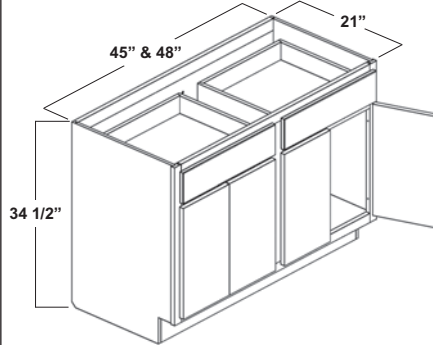

- VB45BPBH
- VB48BPBH

RD	AD	FI	ND	AE	IA	BD	AA
Ⓢ	Ⓢ	Ⓢ	Ⓢ	Ⓢ	⊗	Ⓢ	Ⓢ

Four doors, two drawers
No center stile, 1/8" reveal between doors
No shelves

VANITY SINK DRAWER

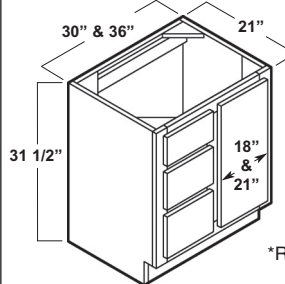

- VSD30LH
- VSD30RH
- VSD36LH
- VSD36RH

*RH as shown

RD	AD	FI	ND	AE	IA	BD	AA
Ⓢ	Ⓢ	Ⓢ	Ⓢ	Ⓢ	⊗	⊗	Ⓢ

One door, two drawers, one false drawer front, no shelves
The basis for determining RH or LH for this cabinet is based on the location of the door. If the door is on the right side of the cabinet and the stack of drawers is on the left side, it would be ordered as a RH (as shown above)
Add FX before Item Code for Drawer Upgrade

VANITY SINK DRAWER, BASE HIGH

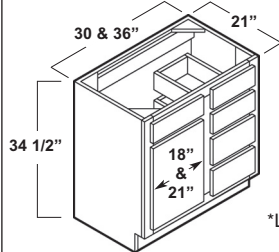

- VSD30BHLH
- VSD30BHRH
- VSD36BHLH
- VSD36BHRH

RD	AD	FI	ND	AE	IA	BD	AA
\$	\$	\$	\$	\$	⊗	⊗	\$

One door, three drawers, two false drawer fronts, no shelves
LH as shown

The basis for determining RH or LH for this cabinet is based on the location of the door. If the door is on the left side of the cabinet and the stack of drawers is on the right side, it would be ordered as a LH (as shown above)
Add FX before Item Code for Drawer Upgrade

VANITY DRAWER LAVATORY

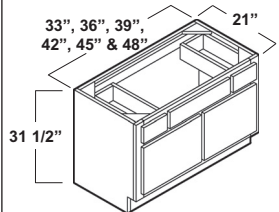

- VDL33
- VDL36
- VDL39
- VDL42
- VDL45
- VDL48

RD	AD	FI	ND	AE	IA	BD	AA
\$	\$	\$	\$	\$	⊗	⊗	\$

Two doors, two drawers, one false drawer front, no shelves
Add FX before Item Code for Drawer Upgrade

VANITY DRAWER LAVATORY, BASE HIGH

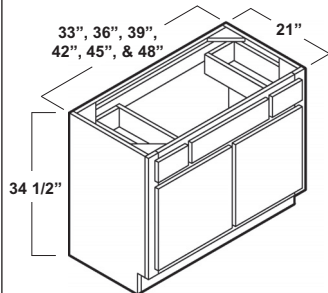

- VDL33BH
- VDL36BH
- VDL39BH
- VDL42BH
- VDL45BH
- VDL48BH

RD	AD	FI	ND	AE	IA	BD	AA
\$	\$	\$	\$	\$	⊗	⊗	\$

Two doors, two drawers, one false drawer front, no shelves
False front in center
Add FX before Item Code for Drawer Upgrade

VANITY DRAWER LAVATORY, BI-PARTING

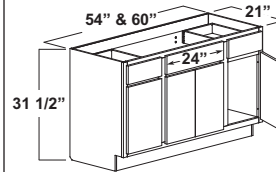

- VDL54BP
- VDL60BP

RD	AD	FI	ND	AE	IA	BD	AA
\$	\$	\$	\$	\$	⊗	⊗	\$

Four doors, two drawers, one false drawer front, no shelves
No center stile, 1/8" reveal between doors
Add FX before Item Code for Drawer Upgrade

VANITY DRAWER LAVATORY, BI-PARTING BASE HIGH

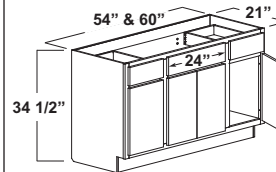

- VDL54BPBH
- VDL60BPBH

RD	AD	FI	ND	AE	IA	BD	AA
\$	\$	\$	\$	\$	⊗	⊗	\$

Four doors, two drawers, one false drawer front, no shelves
No center stile, 1/8" reveal between doors
Add FX before Item Code for Drawer Upgrade

VANITY DRAWER LAVATORY

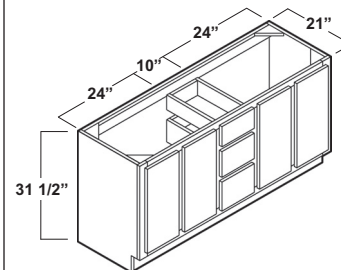

- VDL58

RD	AD	FI	ND	AE	IA	BD	AA
\$	\$	\$	\$	\$	⊗	⊗	\$

Four doors, three drawers, no shelves
Add FX before Item Code for Drawer Upgrade

VANITY CABINETS

- Standard
- Ⓢ Available with an Upcharge
- ⚠ Available with Exceptions
- ⊗ Not Available

Refer to pages 0.21-0.22 for Door and Finish Availability Chart

OPTIONS

- | | |
|-------------------------------|---------------------------------|
| RD Reduce Depth | AE Applied Overlay Ends |
| AD Add Depth | IA Installed Accessories |
| FI Finished Interior | BD Bottom Drawers |
| ND No Doors/No Drawers | AA ADA Adaptable |

VANITY DRAWER LAVATORY, BASE HIGH

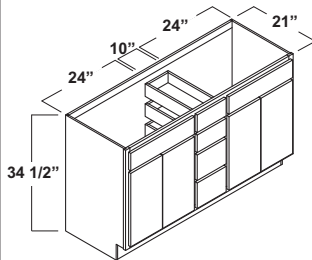

VDL58BH

RD	AD	FI	ND	AE	IA	BD	AA
Ⓢ	Ⓢ	Ⓢ	Ⓢ	Ⓢ	⊗	⊗	Ⓢ

Four doors, four drawers, no shelves
Add FX before Item Code for Drawer Upgrade

VANITY DRAWER LAVATORY

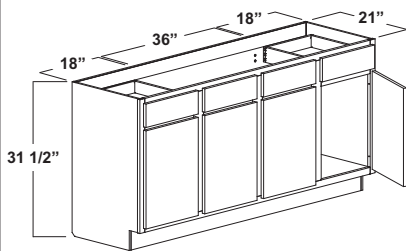

VDL72

RD	AD	FI	ND	AE	IA	BD	AA
Ⓢ	Ⓢ	Ⓢ	Ⓢ	Ⓢ	⊗	⊗	Ⓢ

Four doors, two drawers, two false drawer fronts, no shelves
Add FX before Item Code for Drawer Upgrade

VANITY DRAWER LAVATORY, BASE HIGH

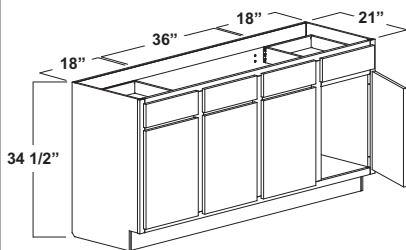

VDL72BH

RD	AD	FI	ND	AE	IA	BD	AA
Ⓢ	Ⓢ	Ⓢ	Ⓢ	Ⓢ	⊗	⊗	Ⓢ

Four doors, two drawers, two false drawer fronts, no shelves
Add FX before Item Code for Drawer Upgrade

VANITY THREE DRAWERS

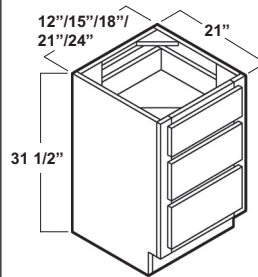

V3D12

V3D15

V3D18

V3D21

V3D24

RD	AD	FI	ND	AE	IA	BD	AA
Ⓢ	Ⓢ	⊗	⊗	Ⓢ	⊗	⊗	Ⓢ

Three drawers
Add FX before Item Code for Drawer Upgrade

VANITY THREE DRAWERS, BASE HIGH

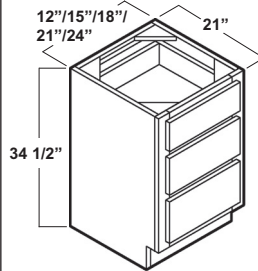

V3D12BH

V3D15BH

V3D18BH

V3D21BH

V3D24BH

RD	AD	FI	ND	AE	IA	BD	AA
Ⓢ	⊗	⊗	⊗	Ⓢ	⊗	⊗	Ⓢ

Three drawers
Add FX before Item Code for Drawer Upgrade
For added depth, order DBP

VANITY FOUR DRAWERS, BASE HIGH

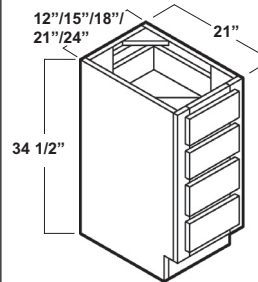

V4D12BH

V4D15BH

V4D18BH

V4D21BH

V4D24BH

RD	AD	FI	ND	AE	IA	BD	AA
Ⓢ	⊗	⊗	⊗	Ⓢ	⊗	⊗	Ⓢ

Four drawers
Add FX before Item Code for Drawer Upgrade
For added depth, order DB

Vanity Bases

VANITY FILE DRAWER

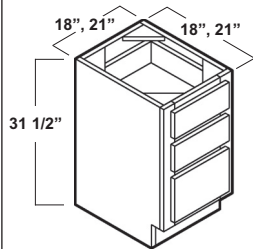

VFD18
VFD21

RD	AD	FI	ND	AE	IA	BD	AA
\$	⊗	⊗	⊗	\$	⊗	⊗	\$

Three drawers
Two shallow height drawers
One deep drawer
Hanging file hardware included
Reducing depth may negate file hardware
Add FX before Item Code for Drawer Upgrade

VANITY FILE DRAWER, BASE HIGH

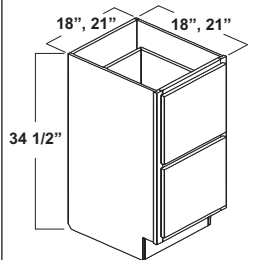

VFD18BH
VFD21BH

RD	AD	FI	ND	AE	IA	BD	AA
\$	⊗	⊗	⊗	\$	⊗	⊗	\$

Two deep drawers
Hanging file hardware included
Reducing depth may negate file hardware
Add FX before Item Code for Drawer Upgrade

Miscellaneous

VANITY LAVATORY FRONT

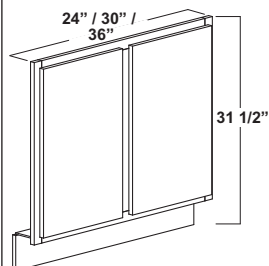

VLF24BP
VLF30
VLF36

Toe plates shipped loose

VANITY DRAWER UNIT

VDU36

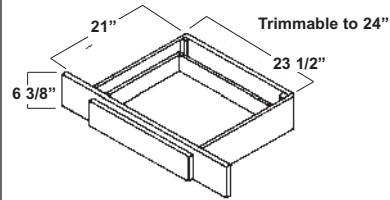

Add FX before Item Code for Drawer Upgrade

VANITY DESK LEG

VLEGF

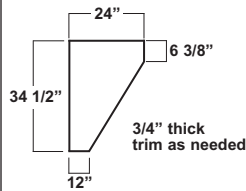

Finished both sides, banded on front edge

Vanity Tops

22" DEEP

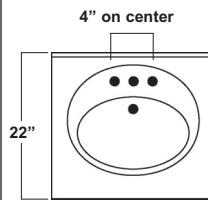

Cultured marble
ORDER SEPARATELY - Integral oval bowl and backsplash. Oval bowl centered with overflow.
White on White

- KC25**
- KC28**
- KC31**
- KC34**
- KC37**
- KC43**
- KC49**
- KC55**
- Left End Splash LES**
- Right End Splash RES**

19" DEEP

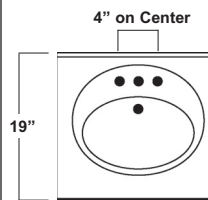

Cultured marble

- MKC2519**
- MKC3119**
- MKC3419**
- MKC3719**

- Standard
- Ⓢ Available with an Upcharge
- ⚠ Available with Exceptions
- ⊗ Not Available

Refer to pages 0.21-0.22 for Door and Finish Availability Chart

OPTIONS

- RD Reduce Depth
- AE Applied Overlay Ends
- AD Add Depth
- IA Installed Accessories
- FI Finished Interior
- BD Bottom Drawers
- ND No Doors/No Drawers
- AA ADA Adaptable

17" DEEP

KC1917

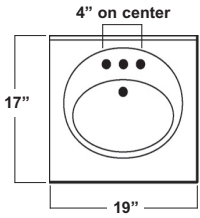

Cultured marble

Wall Cabinets

VANITY WALL CABINET

VWC156

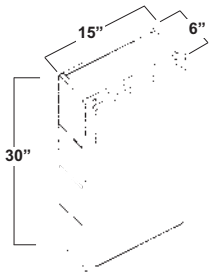

RD	AD	FI	ND	AE	IA	BD	AA
⊗	⊗	Ⓢ	Ⓢ	Ⓢ	⊗	⊗	⊗

One door, two adjustable shelves
Specify RH or LH on Arch styles

VANITY WALL CABINET

VWC2436

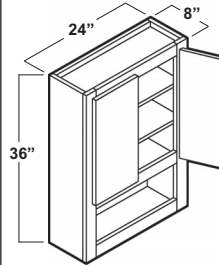

RD	AD	FI	ND	AE	IA	BD	AA
⊗	⊗	●	Ⓢ	Ⓢ	⊗	⊗	⊗

Two doors, two adjustable shelves, one open shelf
Finished Interior

Accessories

Some accessories not available in Birch.
In this case, Maple will be substituted.

Bookcases & Desk Organizers

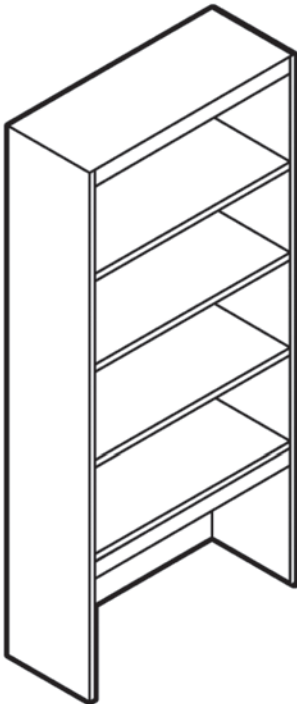

Fillers/
Filler Boxes

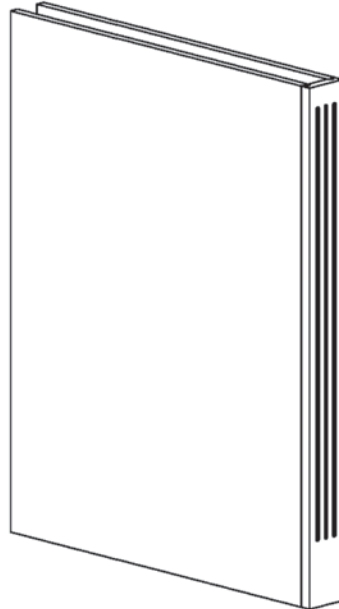

Installed Accessories

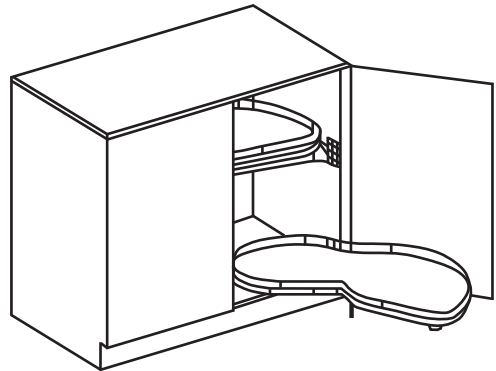

Full & Split
Turnings



Corbels &
Onlays



Decorative Overlay Doors

DECORATIVE OVERLAY DOORS

Representative
of door shown



Overlay door sets for UC's consist of 1 top door and 1 bottom door - 24" deep UC's need 2 sets. It is recommended when using standard overlay doors, that an Overlay End (OE) be used to flush out an end before the decorative overlay door is applied.

An Overlay End is required when using a full overlay door.

OVDW15
OVDW18
OVDW21
OVDW24
OVDW30
OVDW36
OVDW42
OVDB
OVDV
OVDVBH
OVDUC84S
OVDUC90S
OVDUC96S

FINISHED OVERLAY END PANELS

30" x 11-1/4" for Wall Cabinets	OE3011
36" x 11-1/4" for Wall Cabinets	OE3611
42" x 11-1/4" for Wall Cabinets	OE4211
24" x 23-1/4" for Wall Cabinets	OE2423
48" x 11-1/4" for Bookcases	OE4811
52-1/2" x 11-1/4" for Bookcases	OE5211
58-1/2" x 11-1/4" for Bookcases	OE5811
64-1/2" x 11-1/4" for Bookcases	OE6411
84" x 11-1/4" for UC Cabinets	OE8411
90" x 11-1/4" for UC Cabinets	OE9011
96" x 11-1/4" for UC Cabinets	OE9611
84" x 23-1/4" for UC & OC Cabinets	OE8423
90" x 23-1/4" for UC & OC Cabinets	OE9023
96" x 23-1/4" for UC & OC Cabinets	OE9623
31-1/2" x 20-1/4" for Vanity Cabinets	OE3120
34-1/2" x 23-1/4" for Base Cabinets	OE3423

All are 5/32" Veneered Plywood

LOOSE LAMINATED ENDS (FIELD INSTALLED ONLY)

30" x 11-1/4" for Wall Cabinets	LLE3011
36" x 11-1/4" for Wall Cabinets	LLE3611
42" x 11-1/4" for Wall Cabinets	LLE4211
31-1/2" x 20-1/4" for Vanity Cabinets	LLE3120
34-1/2" x 23-1/4" for Base Cabinets	LLE3423
84" x 11-1/4" for UC Cabinets	LLE8411
90" x 11-1/4" for UC Cabinets	LLE9011
96" x 11-1/4" for UC Cabinets	LLE9611
84" x 23-1/4" for UC & OC Cabinets	LLE8423
90" x 23-1/4" for UC & OC Cabinets	LLE9023
96" x 23-1/4" for UC & OC Cabinets	LLE9623
34-1/2" x 48" Standard Panel	LLE3448
48" x 48" Standard Panel	LLE4848

All are 7/32" Laminated Plywood

Filler Boxes

WALL FILLER BOXES - PLAIN

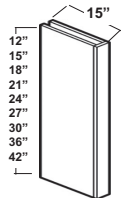

Filler boxes are 5/8" thick veneered plywood end panels joined together with grooved and dado construction
All are 3" wide
Ends are finished
Boxes have flush ends

- WFB12**
- WFB15**
- WFB18**
- WFB21**
- WFB24**
- WFB27**
- WFB30**
- WFB36**
- WFB42**

BASE & VANITY FILLER BOXES - PLAIN

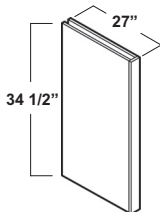

BFB3

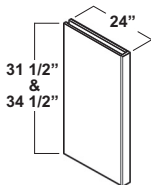

VFB3
VFBBH3

Filler boxes are 5/8" thick veneered plywood end panels joined together with grooved and dado construction
All are 3" wide
Ends are finished

TALL FILLER BOXES - PLAIN

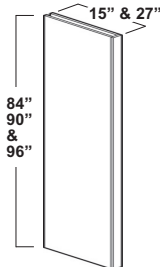

- TFB8415**
- TFB9015**
- TFB9615**
- TFB8427**
- TFB9027**
- TFB9627**

Filler boxes are 5/8" thick veneered plywood end panels joined together with grooved and dado construction
All are 3" wide
Ends are finished
Boxes have flush ends

WALL FILLER BOXES - FLUTED

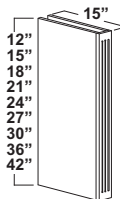

- WFC12**
- WFC15**
- WFC18**
- WFC21**
- WFC24**
- WFC27**
- WFC30**
- WFC36**
- WFC42**

Fluted filler boxes are 5/8" thick veneered plywood end panels joined together with grooved and dado construction. They are the same as plain filler boxes but with a fluted filler
All are 3" wide
Ends are finished
Boxes have flush ends

BASE & VANITY FILLER BOXES - FLUTED

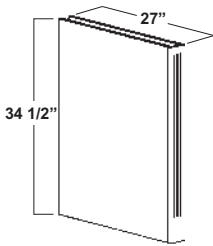

BFC3

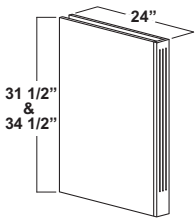

VFC3

VFCBH3

Fluted filler boxes are 5/8" thick veneered plywood end panels joined together with grooved and dado construction. They are the same as plain filler boxes but with a fluted filler

All are 3" wide
Ends are finished
Boxes have flush ends

TALL FILLER BOXES - FLUTED

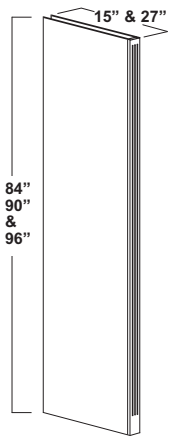

TFC8415

TFC9015

TFC9615

TFC8427

TFC9027

TFC9627

Fluted filler boxes are 5/8" thick veneered plywood end panels joined together with grooved and dado construction. They are the same as plain filler boxes but with a fluted filler

All are 3" wide
Ends are finished
Boxes have flush ends

Wall, Base & Tall Fillers

UNIVERSAL FILLERS (WOOD)

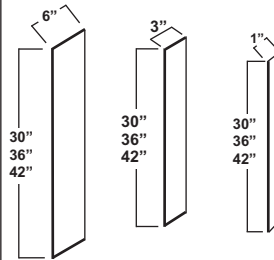

Solid Wood - 3/4" thick

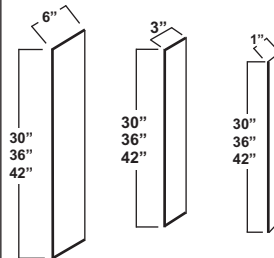

Solid Wood - 3/4" thick

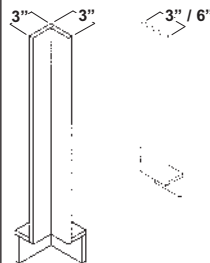

Solid Wood

Base fillers are recommended to assure drawer and door clearance when decorative pulls are added or appliances are adjacent to corner areas

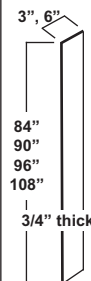

3/4" solid wood

UFWD130

UFWD136

UFWD142

UFWD330

UFWD336

UFWD342

UFWD630

UFWD636

UFWD642

BFWD3

BFWD6

CBFWD3X3

UFWD384

UFWD684

UFWD390

UNIVERSAL FILLERS (WOOD) (continued)

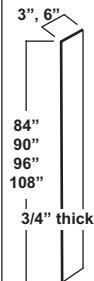

- UFWD690**
- UFWD396**
- UFWD696**
- UFWD3108**
- UFWD6108**

3/4\" solid wood

FLUTED FILLERS

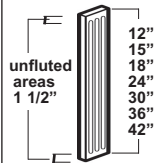

- FS312FL**
- FS315FL**
- FS318FL**
- FS324FL**
- FS330FL**
- FS336FL**
- FS342FL**

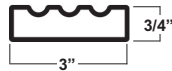

Section View



BF3FL

Base fillers are recommended to assure drawer and door clearance when decorative pulls are added or appliances are adjacent to corner areas

FLUTED FILLERS (continued)

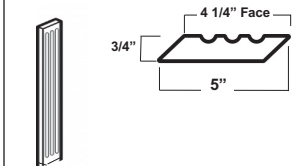

- BAF3FL**
- BAF327FL**

Base fillers are recommended to assure drawer and door clearance when decorative pulls are added or appliances are adjacent to corner areas
Can be used for 27\" high wall cabinets or vanities

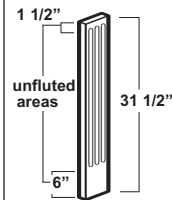

VPF3FL

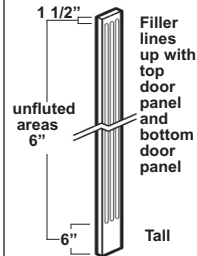

- FS384FL**
- FS390FL**
- FS396FL**

LOOSE UNIVERSAL PROFILED OVERLAY FILLERS*

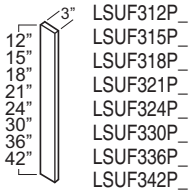

- LSUF312P_
- LSUF315P_
- LSUF318P_
- LSUF321P_
- LSUF324P_
- LSUF330P_
- LSUF336P_
- LSUF342P_

LSUF312P_

LSUF315P_

LSUF318P_

LSUF321P_

LSUF324P_

LSUF330P_

LSUF336P_

LSUF342P_

Profiles Offered



Profile A

*Actual dimensions are 3/8" smaller than shown

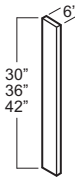

- LSUF630P_
- LSUF636P_
- LSUF642P_

LSUF630P_

LSUF636P_

LSUF642P_

Fillers profiled on four sides



LSCBF3X3P_

LSCBF3X3P_

Fillers profiled on four sides



- LSUF384P_
- LSUF390P_
- LSUF396P_

LSUF384P_

LSUF390P_

LSUF396P_

LSUF3108P_

LSUF6108P_

Fillers profiled and finished on four sides

Profiles Offered



Profile A

LOOSE UNIVERSAL PROFILED OVERLAY FILLERS* (continued)



LSVF3P_

LSVF3P_

Fillers profiled and finished on four sides

Profiles Offered



Profile A

*Actual dimensions are 3/8" smaller than shown

UNIVERSAL FILLERS (WOOD) WITH PROFILED OVERLAY



- UFWD312P_
- UFWD315P_
- UFWD318P_
- UFWD321P_
- UFWD324P_
- UFWD330P_
- UFWD336P_
- UFWD342P_

UFWD312P_

UFWD315P_

UFWD318P_

UFWD321P_

UFWD324P_

UFWD330P_

UFWD336P_

UFWD342P_

Fillers profiled and finished on four sides

Profiles Offered



Profile A

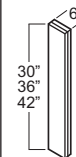

- UFWD630P_
- UFWD636P_
- UFWD642P_

UFWD630P_

UFWD636P_

UFWD642P_

Fillers profiled and finished on four sides

Profiles Offered



Profile A

**UNIVERSAL FILLERS (WOOD)
WITH PROFILED OVERLAY (continued)**

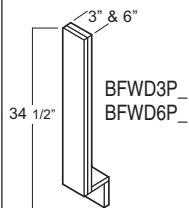

BFWD3P_
BFWD6P_

Fillers profiled and finished on four sides

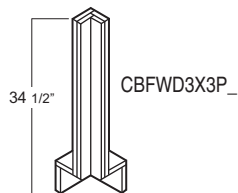

CBFWD3X3P_

Fillers profiled and finished on four sides

Profiles Offered

Profile A

UNIVERSAL FILLERS (WOOD FINISHED ALL EDGES)

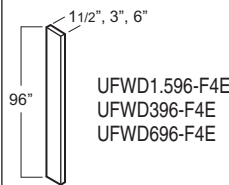

UFWD1.596-F4E
UFWD396-F4E
UFWD696-F4E

Fillers profiled and finished on four sides
Not finished on back side

**UNIVERSAL FILLERS (WOOD)
WITH PROFILED OVERLAY (continued)**

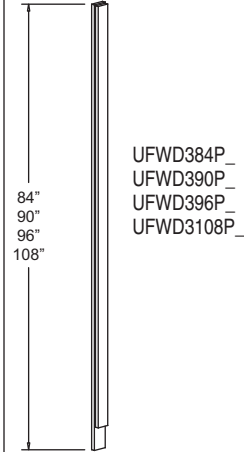

UFWD384P_
UFWD390P_
UFWD396P_
UFWD3108P_
UFWD6108P_

Fillers profiled and finished on four sides

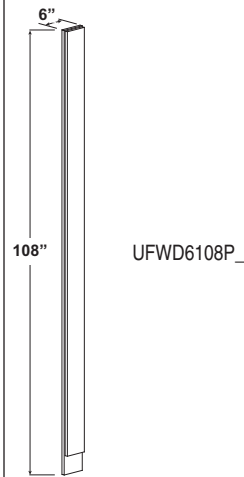

UFWD6108P_

Fillers profiled and finished on four sides

Profiles Offered

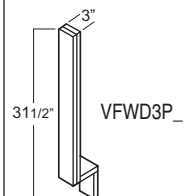
Profile A



VFWD3P_

Fillers profiled and finished on four sides

Profiles Offered

Profile A

Miscellaneous

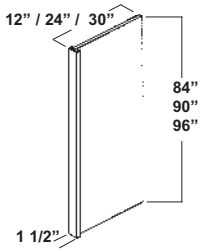
REFRIGERATOR END PANEL



- RP8412**
- RP8424**
- RP8430**
- RP9012**
- RP9024**
- RP9030**

5/8" thick panel
 Birch - contains color laminate on particleboard panels, both sides
 Oak/Maple/Cherry - veneer on particleboard both sides
 Plywood not available in Birch and Thermofoil

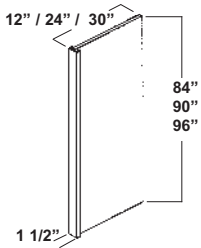

- RP9612**
- RP9624**
- RP9630**

5/8" thick panel
 Birch - contains color laminate on particleboard panels, both sides
 Oak/Maple/Cherry - veneer on particleboard both sides
 Plywood not available in Birch and Thermofoil

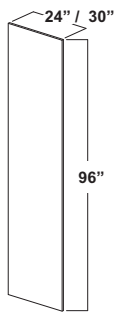

- REP9624**
- REP9630**

3/4" thick panel
 Edge banded two long sides
 Color laminate on particle board both sides

DISHWASHER END PANEL

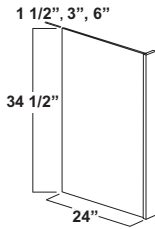

- DWE1.5**
- DWE3**
- DWE3P_**
- DWE6**
- DWE6P_**

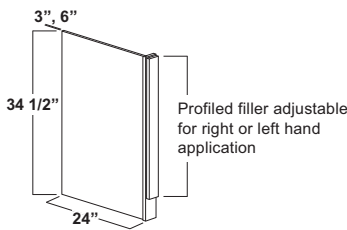

5/8" thick
 One side finished
 DWE3P_ filler profiled on four sides

Profiles Offered

 Profile A

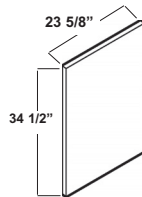
SINK FRONT END



SFE

5/8" thick
 Industrial grade color laminated particleboard both sides
 Edge banded on 34-1/2" side

EDGE MOLDING

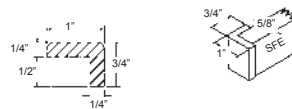

EM34

34-1/2" long
 For use with SFE only, when front of SFE is exposed

Wood Moldings

WOOD MOLDINGS

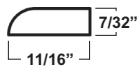

SM96
8' pc. Scribe 11/16"

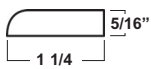

SM96 Box
Box 48' Scribe 11/16"

CM96
8' pc. Cap 1-1/4"

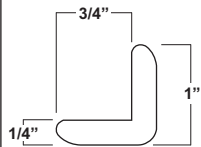

CM96 Box
Box 48' Cap 1-1/4"

CR96
8' pc. Outside Corner 1"

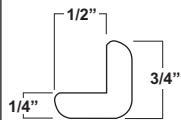

CR96 Box
Box 48' Outside Corner 1"

SCR96
8' pc. Small Outside Corner

SCR96 Box
Box 48' Small Outside Corner

WOOD MOLDINGS

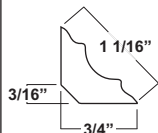

CV96
8' pc. Cove

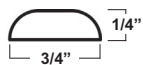

CV96 Box
Box 48' Cove

BM96
8' pc. Batten

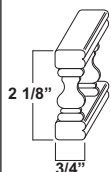

BM96 Box
Box 48' Batten

GR96
8' pc. Galley Rail

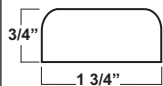

GR96 Box
Box 48' Galley Rail

CTEM96
8' pc. Counter Top Edge

Attaches to countertop

CTEM96 Box
Box 24' Counter Top Edge

WOOD MOLDINGS

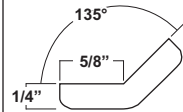

CRA96
8' pc. Angled outside corner

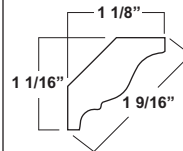

CRA96 Box
Box 48' Angled outside corner

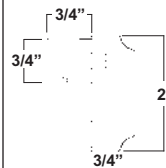

SF96
8' pc. Soffit

SF96 Box
Box 48' Soffit

SF144
12' pc. Soffit

SF144 Box
Box 36' Soffit

LB96
8' pc. Light Bar

LB96 Box
Box 24' Light Bar

WOOD MOLDINGS

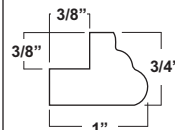

UCT96
8' pc. Under Cabinet Trim

Will not work on Full Overlay

UCT96 Box
Box 48' Under Cabinet Trim

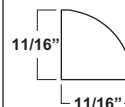

SBM96
8' pc. Shoe Base

SBM96 Box
Box 48' Shoe Base



RM96
8' pc. Rope Strip

RM96 Box
Box 48' Rope Strip

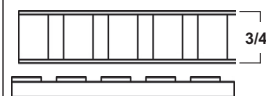

DM96
8' pc. Dentil Strip

DM96 Box
Box 48' Dentil Strip

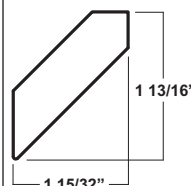

SSCM96
8' pc. Shaker Crown

SSCM96 Box
Box 48' Shaker Crown

WOOD MOLDINGS

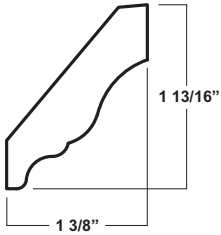

CWN96
8' pc. Crown

CWN96 Box
Box 48' Crown

CWN144
12' pc. Crown

CWN144 Box
Box 36' Crown

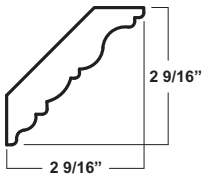

BCWN96
8' pc. Beaded Crown

BCWN96 Box
Box 48' Beaded Crown

BCWN144
12' pc. Beaded Crown

BCWN144 Box
Box 36' Beaded Crown

WOOD MOLDINGS

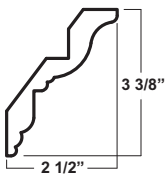

UCWN96
8' pc. Universal Crown

UCWN96 Box
Box 48' Universal Crown

UCWN144
12' pc. Universal Crown

UCWN144 Box
Box 36' Universal Crown

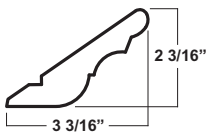

WCWN96
8' pc. Crown

WCWN96 Box
Box 48' Crown

WCWN144
12' pc. Crown

WCWN144 Box
Box 36' Crown

WOOD MOLDINGS

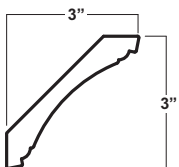

LCV96
8' pc. Large Cove

LCV96 Box
Box 48' Large Cove

LCV144
12' pc. Large Cove

LCV144 Box
Box 36' Large Cove

MOLDINGS FOR FULL OVERLAY DOOR CABINETS

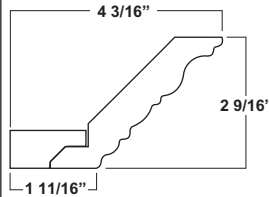

BCWN96C
8' pc. Beaded Crown

BCWN96C Box
Box 24' Beaded Crown

BCWN144C
12' pc. Beaded Crown

BCWN144C Box
Box 36' Beaded Crown

MOLDINGS FOR FULL OVERLAY DOOR CABINETS

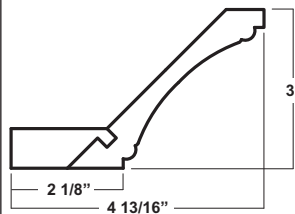

LCV96C
8' pc. Large Cove Crown

LCV96C Box
Box 24' Large Cove Crown

LCV144C
12' pc. Large Cove Crown

LCV144C Box
Box 36' Large Cove Crown

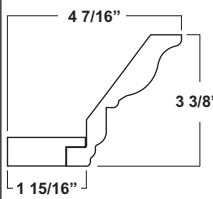

UCWN96C
8' pc. Universal Crown

UCWN96C Box
Box 24' Universal Crown

UCWN144C
12' pc. Universal Crown

UCWN144C Box
Box 36' Universal Crown

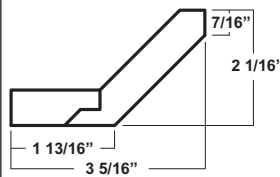

SCM96C
8' pc. Shaker Crown

SCM96C Box
Box 24' Shaker Crown

SCM144C
12' pc. Shaker Crown

SCM144C Box
Box 36' Shaker Crown

WOOD MOLDINGS

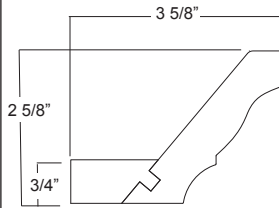

Sold as single pieces only

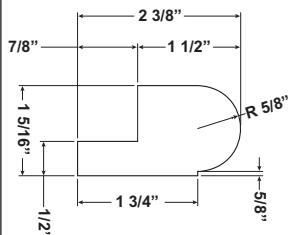

Sold as single pieces only

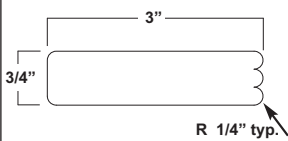

Sold as single pieces only

LCWN96C
8' pc. Large Crown
Molding w/Heel

LCWN144C
12' pc. Large Crown
Molding w/Heel

RLR96
8' pc. Radius Light
Rail Molding

RLR144
12' pc. Radius Light
Rail Molding

TBSM96
8' pc. Triple Bead
Stacked Molding

TBSM144
12' pc. Triple Bead
Stacked Molding

MOLDINGS FOR FULL OVERLAY DOOR CABINETS

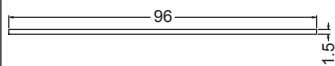

(unfinished) poplar cleat

MLDGCLEAT
8' pc. Molding Cleat

MLDGCLEATBX
Box 48' Molding Cleat

WOOD MOLDINGS - FURNITURE BASE

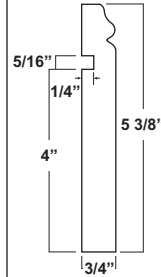

FB96SOL
8' pc. Standard Overlay
Furniture Base
Molding

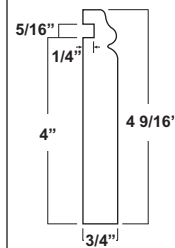

FB96FOL
8' pc. Full Overlay
Furniture Base
Molding

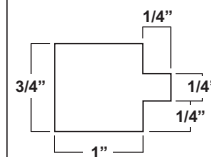

FBMLDGCLEAT
8' pc. Furniture Base
Attachment Cleat

Field cut to fit installation
(unfinished) poplar cleat

WOOD MOLDINGS - STARTER MOLDING

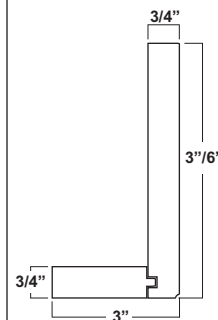

STR396-CV
STR696-CV

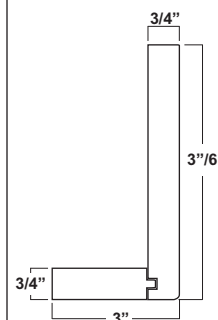

STR396-SH
STR696-SH

Valances & Aprons

SCALLOPED VALANCE



V44
36" to 44"

5/8" Wood Veneer
Available in Oak only
Valances are intended for installation between two walls or a cabinet and a wall
Finished on front and bottom only

V58
44" to 58"

V72
58" to 72"

SOLID WOOD SCALLOPED VALANCE

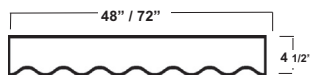

SSCV48
48" x 4-1/2" x 3/4"

SSCV72
72" x 4-1/2" x 3/4"

3/4" Solid Wood
Available in all finishes
Valances are intended for installation between two walls or a cabinet and a wall
Finished on front and bottom only

STRAIGHT VALANCE

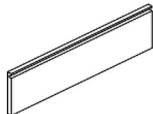

SV48
48" x 6" x 3/4" Solid Wood

SV72
72" x 6" x 3/4" Solid Wood

Thermofoil is painted in MDF
Solid wood is per species
Valances are intended for installation between two walls or a cabinet and a wall
Finished on front and bottom only

See drawing above

SSV48
48" x 6" x 3/4"
Painted MDF

SSV72
72" x 6" x 3/4"
Painted MDF

VSV72
72" x 6" x 3/4"
Veneered MDF

FRIEZE VALANCE

48" Trimmable to 31-1/2"

FV48
48" x 5" x 3/4"

72" Trimmable to 54"

FV72
72" x 5" x 3/4"

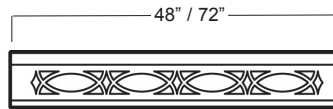

ARCHED VALANCE

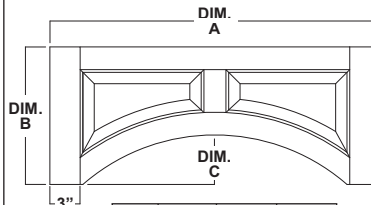

SKU	DIM "A"	DIM "B"	DIM "C"
AV30	30"	12 1/2"	4 1/2"
AV36	36"	12 1/2"	4 1/2"
AV42	42"	15 1/2"	4 1/2"
AV48	48"	15 1/2"	4 1/2"
AV54	54"	15 1/2"	4 1/2"
AV60	60"	18 1/2"	4 1/2"

AV30
AV36
AV42
AV48
AV54
AV60

Trimmable up to 2" on each side

DOUBLE ARCH SCALLOPED FURNITURE APRON

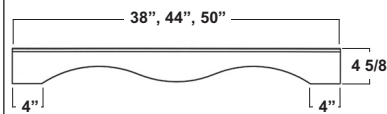

AFA38D
AFA44D
AFA50D

3/4" thick

STRAIGHT FURNITURE APRON



SFA50
SFA74

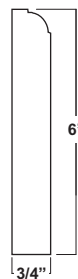

SINGLE ARCHED FURNITURE APRON

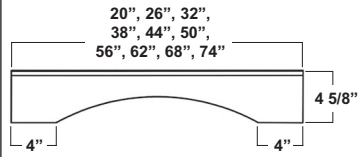

AFA20S

AFA26S

AFA32S

AFA38S

AFA44S

AFA50S

AFA56S

AFA62S

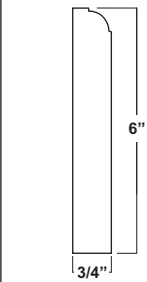

3/4" thick

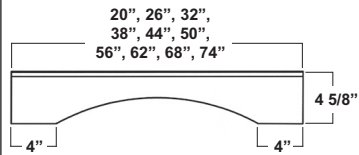

AFA68S

AFA74S



3/4" thick

Onlays & Corbels

ACANTHUS ONLAYS



LONLAYA
Large Onlay

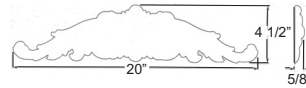

ONLAYA3
Small Ornament

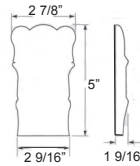

ONLAYA6
Large Ornament

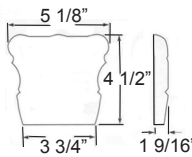

GRAPE ONLAYS

SONLAYGR
Small

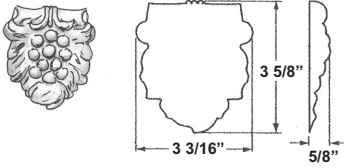

LONLAYGR
Large

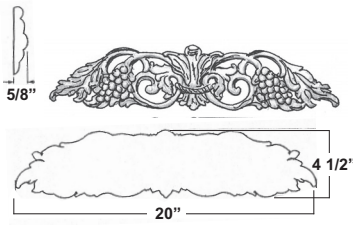

GRCL
Grape Cluster

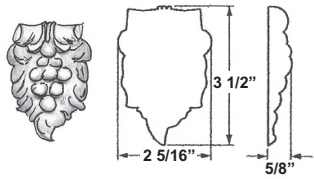

Easy to apply with woodworking glue or a small brad
Available in all finishes

GRAPE CORBELS

GRCOR9
Small

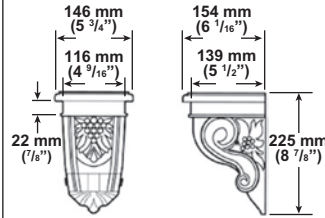

GRCOR13
Medium

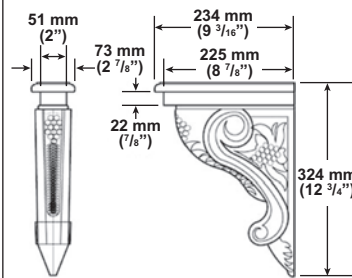

GRCOR24
Large

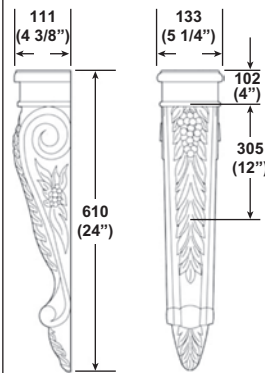

Wood corbels can be mounted with keyhole plates provided and pre-attached
If using the keyhole plates, use #8 or larger screws

SHAKER CORBELS

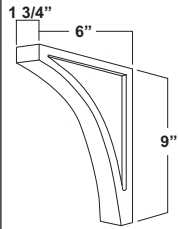

SHCOR9
Small

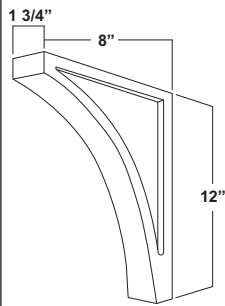

SHCOR12
Medium

ACANTHUS CORBELS

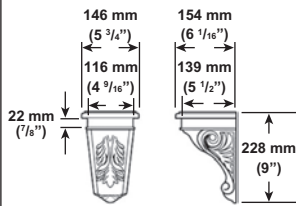

ACOR9
Small

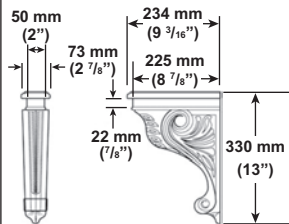

ACOR13
Medium

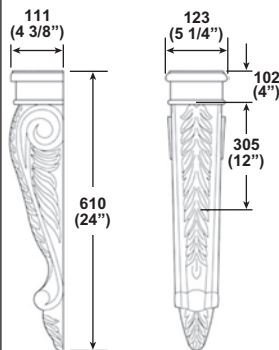

ACOR24
Large

ROSETTE

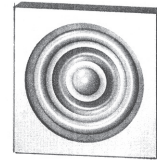

ROS3

3" x 3" x 3/4"
Solid Wood
Smooth on back
No groove to fit on columns

DECORATIVE COUNTER BRACKET

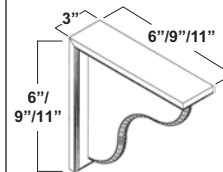

DCB6

DCB9

DCB11

Furniture Feet & Turnings

FURNITURE FEET

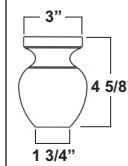

APL

Apple Foot

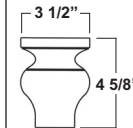

TLL

Tulip Foot

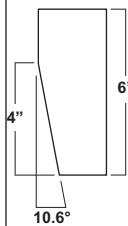

TLG

2-sided Taper Leg
SOLD INDIVIDUALLY

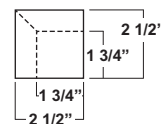

FULL TURNING - PLAIN

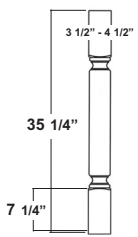

PFT3
3-1/2"

PFT4
4-1/2"

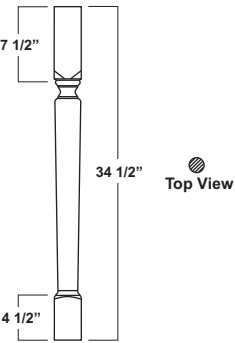

PFT2
2-13/16"

FULL TURNING - REEDED

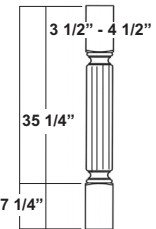

RFT3
3-1/2"

RFT4
4-1/2"

Available in all finishes
16 Reeds on 3-1/2"
20 Reeds on 4-1/2"

SPLIT TURNING

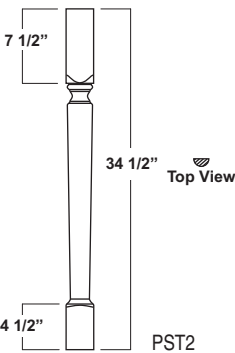

PST2

Turnings & Panels

SPLIT TURNING - PLAIN

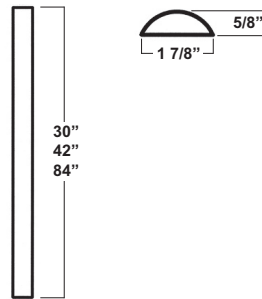

PST30
PST42
PST84

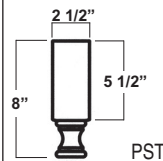

PST

SPLIT TURNING - REEDED

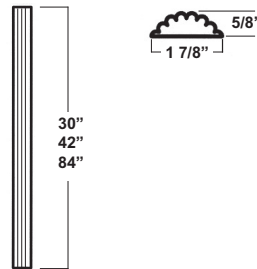

RST30
RST42
RST84

Available in all finishes
Cannot be used by itself

FINISHED PANELS

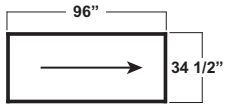
FP96X34
96" x 34-1/2"

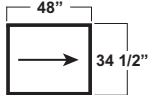
FP48X34
48" x 34-1/2"
Horizontal grain

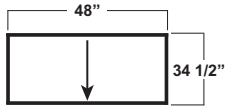
FPC34X48
34-1/2" x 48"
Vertical grain

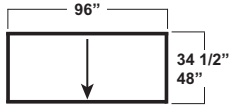
FPC34X96
34-1/2" x 96"
FPC48X96
48" x 96"

All are 3/16" veneered plywood
Painted panels are crossgrain
Run of grain is determined by first dimension

BEAD BOARD PANEL

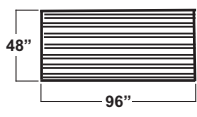
BBP96X48

3/16" veneered plywood

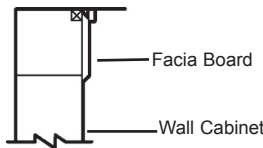
FACIA BOARD PANELS

FB96X12
FB47X12

Facia Board
Wall Cabinet

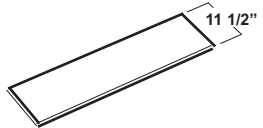
3/16" veneered plywood
One edge rounded and finished
Not available in paints

LOOSE SHELVEING

LS48
48" x 11-1/2" x 3/4"
LS96
96" x 11-1/2" x 3/4"

Finished on two surfaces and front edge
Oak, Birch, Maple, and Cherry are veneered MDF
White is laminated MDF

TOE PLATE COVER - 96" x 4-1/2" x 3/16"

Single 8' pc. **TP96**
Box 48' with 6 pcs. **TP96 BX**

TOE KICK - 96" x 4-1/2" x 1/8"

Single 8' pc. **TK96**
Box 48' with 6 pcs. **TK96 BX**
Laminate Color Match

TOE PLATES

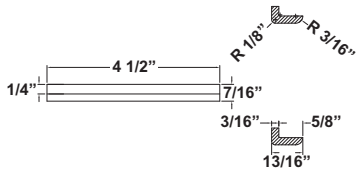
TPEC

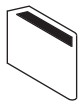
Poly bag - 2 per bag

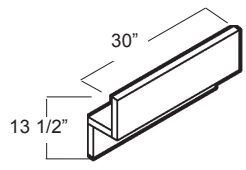
CTP4

Can be attached from front of bases
Particleboard

RTP30F

Base filler for the one piece oven burner units

WOOD SHELF CLEATS

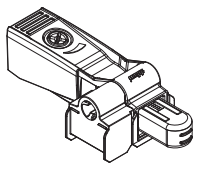
1 per package - need 2 per shelf **LSC1**

DOOR SOFT CLOSE KIT

Blumotion Compact Soft Close **DSCK**

Kit includes mechanism and spacer
For use on doors only

HEAT SHIELDS

18 gauge steel with white powder coat finish **HS2**
 1-9/16" x 30"
 Sold 2 per package

TOUCH-UP AEROSOL SPRAY AND STAIN

PLEASE CONTACT CUSTOMER SERVICE FOR AVAILABILITY
 HAZMAT charges do apply
 Required by DOT, Regulation HM126F
 Hazmat certification is required if an individual is picking up

TOUCH-UP KITS

Contains: Soft filler stick, felt touch-up marker,
 repair pad, and scraper **TUKU**

Contains: Soft filler stick and felt touch-up marker **TUKI**

INSTALLATION ITEMS

*Screw Head Cover - Box 1,000 **BX1MHDCVRS**
 *Only available in natural and white

Edge Band - (25' roll) **EDGEBAND**

5/8" Screws - Box 1,000 (Black) **BX1M58SCREWS**

1-1/8" Screws - Box 1,000 (Nickel) **BX1M118SCREWS**

2" Screws - Box 1,000 (Black) **BX1M2SCREWS**

INSTALLATION ITEMS

2-1/2" Screws - Box 1,000 (Black)
BX1M212SCREWS

3" Screws - Box 1,000 (Black)
BX1M3SCREWS

3-1/2" Screws - Box 1,000 (Black)
BX1M312SCREWS

Angle Brackets - Box 500
 7/8" X 7/8" (5/8" wide) **BX500ANGLEBRACKETS**

Sales Aids

FINISH SAMPLE BOX

Box of Finish Sample Blocks Complete	SBXC
Sample Box Only	SBX
Individual Box Samples	LBM

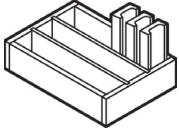
**MINI BASES**

Not shown	Arcadia Maple Tuscany
Note: 12" wide framed Plywood cabinet with Full Extension Soft Close drawer, right end finished	
	Summerfield 1 Maple Café
Note: 12" wide Standard framed cabinet with Full Extension Soft Close drawer	

DOOR PAGERS

Not shown	54 Door Pager
	20 Door Wall Pager

MOLDING CHAINS

Sample Molding Chain	SMC
----------------------	------------

DOOR SAMPLES (DOOR ONLY)

Sample door, no bore	SD3018
Sample door, hinged for pager Specify LH or RH when ordering	PD3018

DOOR SAMPLES BAGS

Small (for SD3018)
Large (for 50s and 45s)

FACE FRAME AND DRAWER SAMPLES

Arch Door (Does not show drawer head)	50
Square Door (Shows drawer head)	45

LITERATURE

Note: Includes Policies and Procedures, literature for Framed and Frameless styles, Price and Specifications books	Dealer Binder
--	----------------------

Note: Call for availability

WOOD SURFACES

For normal cleaning use a clean soft cloth dampened with a mild solution of two drops of dishwashing liquid per one gallon of water.

Dry off thoroughly, removing any excess moisture.

DO NOT USE STRONG DETERGENTS, SOLVENTS, OR ABRASIVE CLEANERS.

Do not use a dish cloth on cabinet surfaces.

THERMOFOIL AND MELAMINE SURFACES

For normal cleaning use a clean soft cloth dampened with a mild solution of two drops of dishwashing liquid per one gallon of water.

Dry off thoroughly, removing any excess moisture.

DO NOT USE STRONG DETERGENTS, SOLVENTS, OR ABRASIVE CLEANERS.

Do not use a dish cloth on cabinet surfaces.

All **non-abrasive** household cleaners may be used. Examples: Simple Green, Formula 409, etc.

When using a self-cleaning oven, opening all the adjacent doors and drawers or using heat shields is recommended. This is to help prevent damage and discoloration of the cabinets.

MOISTURE FROM STEAM AND HOT WATER PRESENT IN KITCHENS SHOULD BE KEPT OFF OF ALL CABINETS. IF CABINETS DO GET WET, DRY THEM BY WIPING WITH A CLEAN SOFT DRY CLOTH TO MAINTAIN FINISH.

NOTE: When using the self cleaning oven function, it is best to remove the drawers/doors from the adjacent cabinet(s) and oven cabinet.



NOTES

NOTES

Door/Drawer Head

Dimensions and Price List

ORDER PARTS REFERENCE

SUPPLY ORDER PARTS REFERENCE—Bases & Vanities

SUPPLY ORDER PARTS REFERENCE

FH / DCB / BTC

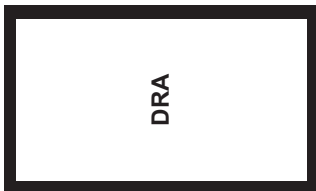

FH BP / WC BP



FH / BEC / RW



PB / VB / BSB / VS / DSB



RPBC

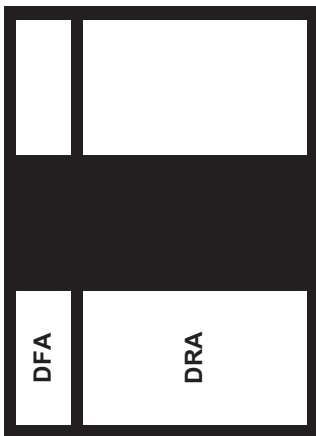

V3D



VFD



D2B / VFDBH



D3B / V3DBH



D4B / V4DBH



MWB / MWB TRM

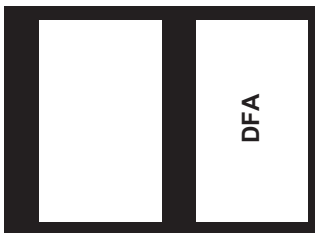

VSD (R & L) Current

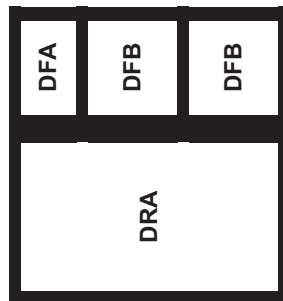

VSDBH (R & L) Current

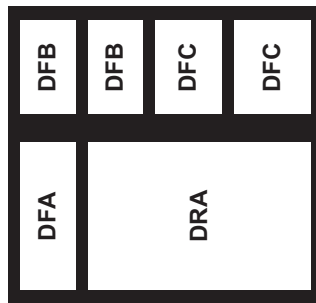

CB



CAR



FSB

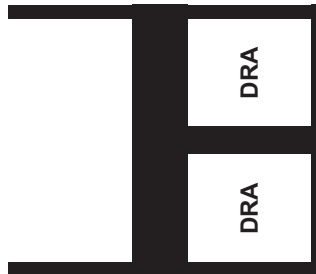

SUPPLY ORDER PARTS REFERENCE—Bases & Vanities

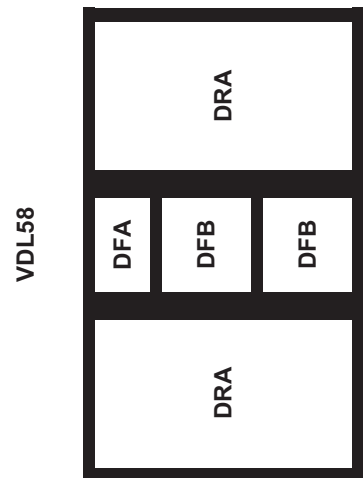
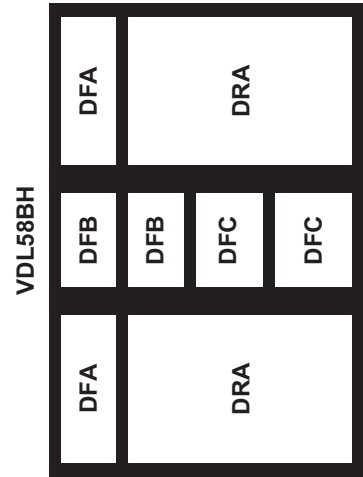
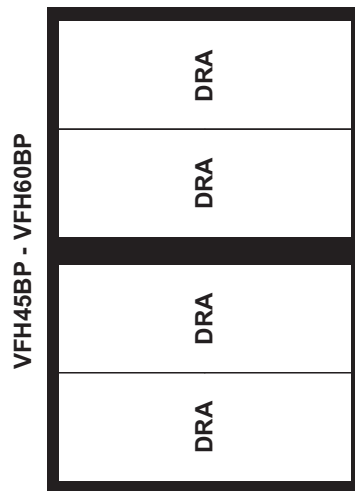
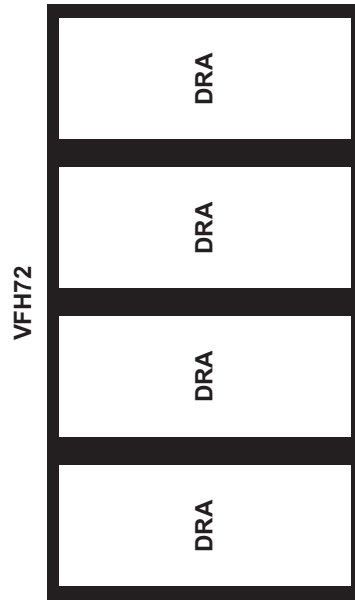
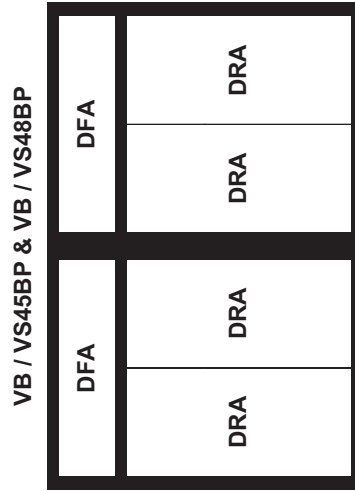
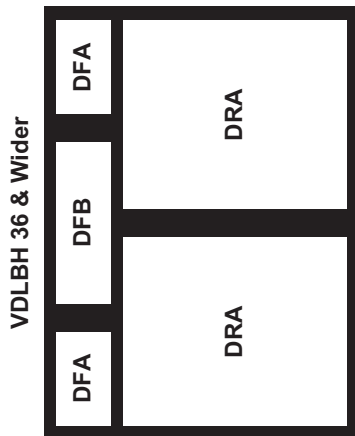
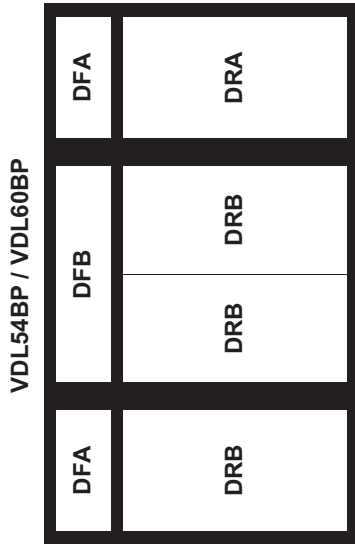
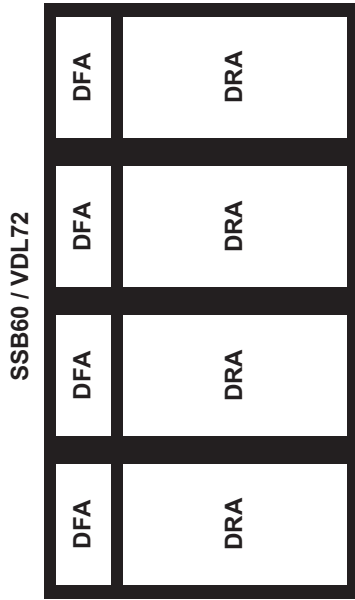

SUPPLY ORDER PARTS REFERENCE—Wall & Tall Cabinets

SUPPLY ORDER PARTS REFERENCE

WC / CWC / WEC

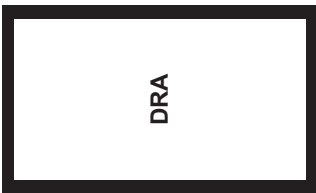

WC / EZCW / WEA



WCC

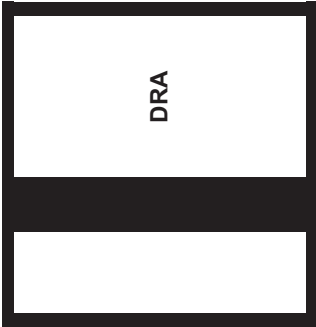

WCC

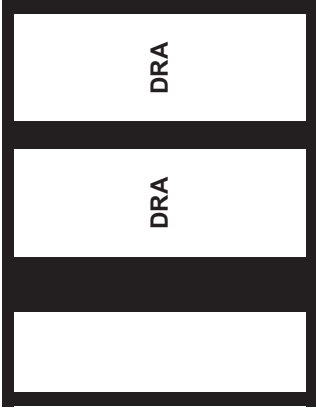

WCMW

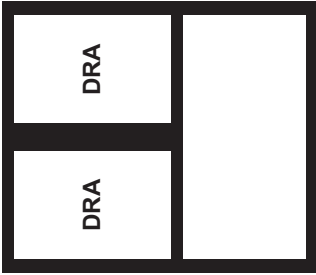

RW45BP & RW48BP

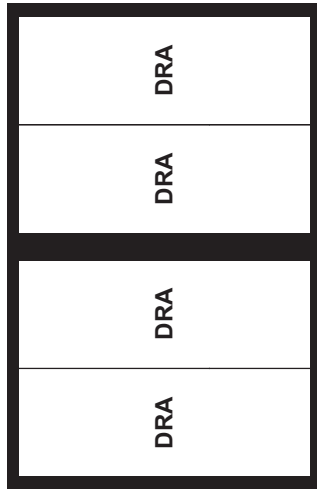

VWC2436

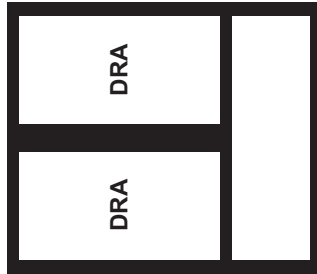

Tall Cabinets

Oven Cabinet



Utility Cabinet

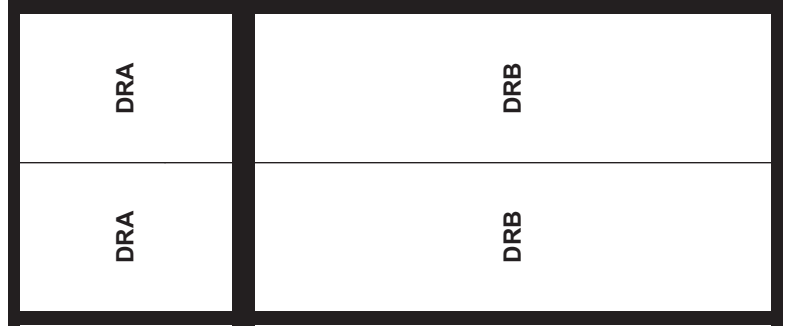

Open Cabinets

BC

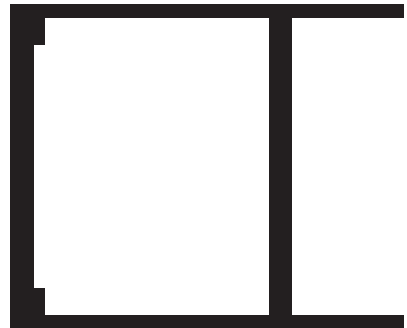

AH



SUPPLEMENTAL PARTS – SOL

SKU	MAP	TYPE	PART ID	QTY	WIDTH	HEIGHT
#45 SAMPLE	DRA	DR	1218	1	10	16
#45 SAMPLE	DFA	DF	PB12	1	10	5 1/4
BEC24	DRA	DR	BEC	2	15 3/4	28
BFH12	DRA	DR	1230	1	10	28
BFH15	DRA	DR	1530	1	13	28
BFH18	DRA	DR	1830	1	16	28
BFH21	DRA	DR	2130	1	19	28
BFH24	DRA	DR	2430	1	22	28
BFH24BP	DRA	DR	2430BP	2	10 15/16	28
BFH27	DRA	DR	2730	2	11 1/2	28
BFH27BP	DRA	DR	2730BP	2	12 7/16	28
BFH30	DRA	DR	1530	2	13	28
BFH30BP	DRA	DR	3030BP	2	13 15/16	28
BFH33	DRA	DR	3330	2	14 1/2	28
BFH33BP	DRA	DR	3330BP	2	15 7/16	28
BFH36	DRA	DR	1830	2	16	28
BFH36BP	DRA	DR	3630BP	2	16 15/16	28
BFH39	DRA	DR	3930	2	17 1/2	28
BFH42	DRA	DR	2130	2	19	28
BFH45	DRA	DR	4530	2	20 1/2	28
BFH48	DRA	DR	2430	2	22	28
BFH9	DRA	DR	930	1	7	28
BSB24	DRA	DR	2424	1	22	22
BSB24	DFA	DF	PB24	1	22	5 1/4
BSB24BP	DRA	DR	2424BP	2	10 15/16	22
BSB24BP	DFA	DF	PB24	1	22	5 1/4
BSB27	DRA	DR	2724	2	11 1/2	22
BSB27	DFA	DF	PB27	2	11 1/2	5 1/4
BSB27BP	DRA	DR	2724BP	2	12 7/16	22
BSB27BP	DFA	DF	PB27BP	1	25	5 1/4
BSB30	DRA	DR	1524	2	13	22
BSB30	DFA	DF	PB15	2	13	5 1/4
BSB30BP	DRA	DR	3024BP	2	13 15/16	22
BSB30BP	DFA	DF	PB30BP	1	28	5 1/4
BSB33	DRA	DR	3324	2	14 1/2	22
BSB33	DFA	DF	PB33	2	14 1/2	5 1/4
BSB33BP	DRA	DR	3324BP	2	15 7/16	22
BSB33BP	DFA	DF	PB33BP	1	31	5 1/4
BSB36	DRA	DR	1824	2	16	22
BSB36	DFA	DF	PB18	2	16	5 1/4
BSB36BP	DRA	DR	3624BP	2	16 15/16	22
BSB36BP	DFA	DF	PB36BP	1	34	5 1/4
BSB39	DRA	DR	3924	2	17 1/2	22
BSB39	DFA	DF	PB39	2	17 1/2	5 1/4
BSB42	DRA	DR	2124	2	19	22
BSB42	DFA	DF	PB21	2	19	5 1/4
BSB45	DRA	DR	4524	2	20 1/2	22
BSB45	DFA	DF	PB45	2	20 1/2	5 1/4
BSB48	DRA	DR	2424	2	22	22
BSB48	DFA	DF	PB24	2	22	5 1/4
BSF12	DRA	DR	1224	1	10	22
BSF12	DFA	DF	PB12	1	10	5 1/4
BSF15	DRA	DR	1524	1	13	22
BSF15	DFA	DF	PB15	1	13	5 1/4
BSF18	DRA	DR	1824	1	16	22
BSF18	DFA	DF	PB18	1	16	5 1/4
BSF21	DRA	DR	2124	1	19	22
BSF21	DFA	DF	PB21	1	19	5 1/4

SUPPLEMENTAL PARTS – SOL

SKU	MAP	TYPE	PART ID	QTY	WIDTH	HEIGHT
BSF24	DRA	DR	2424	1	22	22
BSF24	DFA	DF	PB24	1	22	5 1/4
BSF27	DRA	DR	2724	2	11 1/2	22
BSF27	DFA	DF	PB27	2	11 1/2	5 1/4
BSF30	DRA	DR	1524	2	13	22
BSF30	DFA	DF	PB15	2	13	5 1/4
BSF33	DRA	DR	3324	2	14 1/2	22
BSF33	DFA	DF	PB33	2	14 1/2	5 1/4
BSF36	DRA	DR	1824	2	16	22
BSF36	DFA	DF	PB18	2	16	5 1/4
BSF39	DRA	DR	3924	2	17 1/2	22
BSF39	DFA	DF	PB39	2	17 1/2	5 1/4
BSF42	DRA	DR	2124	2	19	22
BSF42	DFA	DF	PB21	2	19	5 1/4
BSF45	DRA	DR	4524	2	20 1/2	22
BSF45	DFA	DF	PB45	2	20 1/2	5 1/4
BSF48	DRA	DR	2424	2	22	22
BSF48	DFA	DF	PB24	2	22	5 1/4
BSF9	DRA	DR	924	1	7	22
BSF9	DFA	DF	PB9	1	7	5 1/4
BTC12LH	DRA	DR	WEC30	1	13 5/8	28
BTC12RH	DRA	DR	WEC30	1	13 5/8	28
CAR3636	DRA	DR	CARS	1	10 7/16	26 9/16
CAR3636	DRB	DR	CARL	1	10 7/8	26 9/16
CSF165	DRA	DR	1524	1	13	22
CSF165	DFA	DF	PB15	1	13	5 1/4
CSF255	DRA	DR	2424	1	22	22
CSF255	DFA	DF	PB24	1	22	5 1/4
CWC2424	DRA	DR	CW24	1	15	22
CWC2424	DRA	GL	CW24	1	15	22
CWC2424	DRA	MD	CW24	1	15	22
CWC2430	DRA	DR	CW30	1	15	28
CWC2430	DRA	GL	CW30	1	15	28
CWC2430	DRA	MD	CW30	1	15	28
CWC2436	DRA	DR	CW36	1	15	34
CWC2436	DRA	GL	CW36	1	15	34
CWC2436	DRA	MD	CW36	1	15	34
CWC2442	DRA	DR	CW42	1	15	40
CWC2442	DRA	GL	CW42	1	15	40
CWC2442	DRA	MD	CW42	1	15	40
CWC2724	DRA	DR	CW24	1	15	22
CWC2724	DRA	GL	CW24	1	15	22
CWC2724	DRA	MD	CW24	1	15	22
CWC2730	DRA	DR	CW30	1	15	28
CWC2730	DRA	GL	CW30	1	15	28
CWC2730	DRA	MD	CW30	1	15	28
CWC2736	DRA	DR	CW36	1	15	34
CWC2736	DRA	GL	CW36	1	15	34
CWC2736	DRA	MD	CW36	1	15	34
CWC2742	DRA	DR	CW42	1	15	40
CWC2742	DRA	GL	CW42	1	15	40
CWC2742	DRA	MD	CW42	1	15	40
D2B18	DFA	DF	D2B18	2	16	13 7/16
D2B21	DFA	DF	D2B21	2	19	13 7/16
D2B24	DFA	DF	D2B24	2	22	13 7/16
D2B27	DFA	DF	D2B27	2	25	13 7/16
D2B30	DFA	DF	D2B30	2	28	13 7/16
D2B33	DFA	DF	D2B33	2	31	13 7/16

SUPPLEMENTAL PARTS – SOL

SKU	MAP	TYPE	PART ID	QTY	WIDTH	HEIGHT
D2B36	DFA	DF	D2B36	2	34	13 7/16
D3B12	DFA	DF	PB12	1	10	5 1/4
D3B12	DFB	DF	D3B12	2	10	10 1/2
D3B15	DFA	DF	PB15	1	13	5 1/4
D3B15	DFB	DF	D3B15	2	13	10 1/2
D3B18	DFA	DF	PB18	1	16	5 1/4
D3B18	DFB	DF	D3B18	2	16	10 1/2
D3B21	DFA	DF	PB21	1	19	5 1/4
D3B21	DFB	DF	D3B21	2	19	10 1/2
D3B24	DFA	DF	PB24	1	22	5 1/4
D3B24	DFB	DF	D3B24	2	22	10 1/2
D3B27	DFA	DF	PB27BP	1	25	5 1/4
D3B27	DFB	DF	D3B27	2	25	10 1/2
D3B30	DFA	DF	PB30BP	1	28	5 1/4
D3B30	DFB	DF	D3B30	2	28	10 1/2
D3B33	DFA	DF	PB33BP	1	31	5 1/4
D3B33	DFB	DF	D3B33	2	31	10 1/2
D3B36	DFA	DF	PB36BP	1	34	5 1/4
D3B36	DFB	DF	D3B36	2	34	10 1/2
DSB3636	DRA	DR	CW24	1	15	22
DSB3636	DFA	DF	DSB3636	1	15	5 1/4
D4B12	DFA	DF	PB12	2	10	5 1/4
D4B12	DFB	DF	D4B12	2	10	7 5/8
D4B15	DFA	DF	PB15	2	13	5 1/4
D4B15	DFB	DF	D4B15	2	13	7 5/8
D4B18	DFA	DF	PB18	2	16	5 1/4
D4B18	DFB	DF	D4B18	2	16	7 5/8
D4B21	DFA	DF	PB21	2	19	5 1/4
D4B21	DFB	DF	D4B21	2	19	7 5/8
D4B24	DFA	DF	PB24	2	22	5 1/4
D4B24	DFB	DF	D4B24	2	22	7 5/8
D4B27	DFA	DF	PB27BP	2	25	5 1/4
D4B27	DFB	DF	D4B27	2	25	7 5/8
D4B30	DFA	DF	PB30BP	2	28	5 1/4
D4B30	DFB	DF	D4B30	2	28	7 5/8
D4B33	DFA	DF	PB33BP	2	31	5 1/4
D4B33	DFB	DF	D4B33	2	31	7 5/8
D4B36	DFA	DF	PB36BP	2	34	5 1/4
D4B36	DFB	DF	D4B36	2	34	7 5/8
DSB42BP	DRA	DR	DSB42BP	2	11 5/8	22
DSB42BP	DFA	DF	DSB42	1	23 3/8	5 1/4
EZCB3333	DRA	DR	33	2	7 3/8	28
EZCB3636	DRA	DR	CB36	2	10 3/8	28
EZCW24	DRA	DR	CNR24	2	10 3/8	22
EZCW30	DRA	DR	CB36	2	10 3/8	28
EZCW36	DRA	DR	CNR36	2	10 3/8	34
EZCW42	DRA	DR	CNR42	2	10 3/8	40
EZDCB3636	DRA	DR	CW30	1	15	28
FSB30	DRA	DR	1518	2	13	16
FSB30BP	DRA	DR	3018BP	2	13 15/16	16
FSB33	DRA	DR	3318	2	14 1/2	16
FSB33BP	DRA	DR	3318BP	2	15 7/16	16
FSB36	DRA	DR	1818	2	16	16
FSB36BP	DRA	DR	3618BP	2	16 15/16	16
IB24	DRA	DR	2424	2	22	22
IB24	DFA	DF	PB24	2	22	5 1/4
IB24BP	DRA	DR	2424BP	4	10 15/16	22
IB24BP	DFA	DF	PB24	2	22	5 1/4

SUPPLEMENTAL PARTS – SOL

SKU	MAP	TYPE	PART ID	QTY	WIDTH	HEIGHT
IB30	DRA	DR	1524	4	13	22
IB30	DFA	DF	PB15	4	13	5 1/4
IB30BP	DRA	DR	3024BP	4	13 15/16	22
IB30BP	DFA	DF	PB30BP	2	28	5 1/4
IB36	DRA	DR	1824	4	16	22
IB36	DFA	DF	PB18	4	16	5 1/4
IB36BP	DRA	DR	3624BP	4	16 15/16	22
IB36BP	DFA	DF	PB36BP	2	34	5 1/4
IB48	DRA	DR	2424	4	22	22
IB48	DFA	DF	PB24	4	22	5 1/4
IFH24	DRA	DR	2430	2	22	28
IFH24BP	DRA	DR	2430BP	4	10 15/16	28
IFH30	DRA	DR	1530	4	13	28
IFH30BP	DRA	DR	3030BP	4	13 15/16	28
IFH36	DRA	DR	1830	4	16	28
IFH36BP	DRA	DR	3630BP	4	16 15/16	28
IFH48	DRA	DR	2430	4	22	28
ISB24	DRA	DR	2424	2	22	22
ISB24	DFA	DF	PB24	2	22	5 1/4
ISB24BP	DRA	DR	2424BP	4	10 15/16	22
ISB24BP	DFA	DF	PB24	2	22	5 1/4
ISB30	DRA	DR	1524	4	13	22
ISB30	DFA	DF	PB15	4	13	5 1/4
ISB30BP	DRA	DR	3024BP	4	13 15/16	22
ISB30BP	DFA	DF	PB30BP	2	28	5 1/4
ISB36	DRA	DR	1824	4	16	22
ISB36	DFA	DF	PB18	4	16	5 1/4
ISB36BP	DRA	DR	3624BP	4	16 15/16	22
ISB36BP	DFA	DF	PB36BP	2	34	5 1/4
ISB48	DRA	DR	2424	4	22	22
ISB48	DFA	DF	PB24	4	22	5 1/4
IW3018	DRA	DR	1518	4	13	16
IW3018	DRA	GL	1518	4	13	16
IW3018	DRA	MD	1518	4	13	16
IW3018BP	DRA	DR	3018BP	4	13 15/16	16
IW3018BP	DRA	GL	3018BP	4	13 15/16	16
IW3018BP	DRA	MD	3018BP	4	13 15/16	16
IW3030	DRA	DR	1530	4	13	28
IW3030	DRA	GL	1530	4	13	28
IW3030	DRA	MD	1530	4	13	28
IW3030BP	DRA	DR	3030BP	4	13 15/16	28
IW3030BP	DRA	GL	3030BP	4	13 15/16	28
IW3030BP	DRA	MD	3030BP	4	13 15/16	28
LSCB3333	DRA	DR	33	2	7 3/8	28
LSCB3636	DRA	DR	CB36	2	10 3/8	28
LSDCB3636	DRA	DR	CW30	1	15	28
MB12	DRA	DR	1218	1	10	16
MB12	DFA	DF	PB12	1	10	5 1/4
MWB TRM24	DFA	DF	DBP24	1	22	10 1/2
MWB TRM27	DFA	DF	DBP27	1	25	10 1/2
MWB TRM30	DFA	DF	DBP30	1	28	10 1/2
MWB24	DFA	DF	DBP24	1	22	10 1/2
MWB27	DFA	DF	DBP27	1	25	10 1/2
MWB30	DFA	DF	DBP30	1	28	10 1/2
OC3084T	DRA	DR	2718	2	11 1/2	16
OC3084T	DFA	DF	DB27	3	25	7 5/8
OC3090T	DRA	DR	2724	2	11 1/2	22
OC3090T	DFA	DF	DB27	3	25	7 5/8

SUPPLEMENTAL PARTS – SOL

SKU	MAP	TYPE	PART ID	QTY	WIDTH	HEIGHT
OC3096T	DRA	DR	2730	2	11 1/2	28
OC3096T	DFA	DF	DB27	3	25	7 5/8
OC3384T	DRA	DR	1518	2	13	16
OC3384T	DFA	DF	DB30	3	28	7 5/8
OC3390T	DRA	DR	1524	2	13	22
OC3390T	DFA	DF	DB30	3	28	7 5/8
OC3396T	DRA	DR	1530	2	13	28
OC3396T	DFA	DF	DB30	3	28	7 5/8
PB12	DRA	DR	1224	1	10	22
PB12	DFA	DF	PB12	1	10	5 1/4
PB15	DRA	DR	1524	1	13	22
PB15	DFA	DF	PB15	1	13	5 1/4
PB18	DRA	DR	1824	1	16	22
PB18	DFA	DF	PB18	1	16	5 1/4
PB21	DRA	DR	2124	1	19	22
PB21	DFA	DF	PB21	1	19	5 1/4
PB24	DRA	DR	2424	1	22	22
PB24	DFA	DF	PB24	1	22	5 1/4
PB24BP	DRA	DR	2424BP	2	10 15/16	22
PB24BP	DFA	DF	PB24	1	22	5 1/4
PB27	DRA	DR	2724	2	11 1/2	22
PB27	DFA	DF	PB27	2	11 1/2	5 1/4
PB27BP	DRA	DR	2724BP	2	12 7/16	22
PB27BP	DFA	DF	PB27BP	1	25	5 1/4
PB30	DRA	DR	1524	2	13	22
PB30	DFA	DF	PB15	2	13	5 1/4
PB30BP	DRA	DR	3024BP	2	13 15/16	22
PB30BP	DFA	DF	PB30BP	1	28	5 1/4
PB33	DRA	DR	3324	2	14 1/2	22
PB33	DFA	DF	PB33	2	14 1/2	5 1/4
PB33BP	DRA	DR	3324BP	2	15 7/16	22
PB33BP	DFA	DF	PB33BP	1	31	5 1/4
PB36	DRA	DR	1824	2	16	22
PB36	DFA	DF	PB18	2	16	5 1/4
PB36BP	DRA	DR	3624BP	2	16 15/16	22
PB36BP	DFA	DF	PB36BP	1	34	5 1/4
PB39	DRA	DR	3924	2	17 1/2	22
PB39	DFA	DF	PB39	2	17 1/2	5 1/4
PB42	DRA	DR	2124	2	19	22
PB42	DFA	DF	PB21	2	19	5 1/4
PB45	DRA	DR	4524	2	20 1/2	22
PB45	DFA	DF	PB45	2	20 1/2	5 1/4
PB48	DRA	DR	2424	2	22	22
PB48	DFA	DF	PB24	2	22	5 1/4
PB9	DRA	DR	924	1	7	22
PB9	DFA	DF	PB9	1	7	5 1/4
RPBC36	DRA	DR	1224	1	10	22
RPBC36	DFA	DF	PB12	1	10	5 1/4
RPBC39	DRA	DR	1224	1	10	22
RPBC39	DFA	DF	PB12	1	10	5 1/4
RPBC42	DRA	DR	1524	1	13	22
RPBC42	DFA	DF	PB15	1	13	5 1/4
RPBC45	DRA	DR	1824	1	16	22
RPBC45	DFA	DF	PB18	1	16	5 1/4
RPBC48	DRA	DR	2124	1	19	22
RPBC48	DFA	DF	PB21	1	19	5 1/4

SUPPLEMENTAL PARTS – SOL

SKU	MAP	TYPE	PART ID	QTY	WIDTH	HEIGHT
RW3012	DRA	DR	1512	2	13	10
RW3012	DRA	GL	1512	2	13	10
RW3012	DRA	MD	1512	2	13	10
RW3015	DRA	DR	1515	2	13	13
RW3015	DRA	GL	1515	2	13	13
RW3015	DRA	MD	1515	2	13	13
RW3018	DRA	DR	1518	2	13	16
RW3018	DRA	GL	1518	2	13	16
RW3018	DRA	MD	1518	2	13	16
RW3021	DRA	DR	1521	2	13	19
RW3021	DRA	GL	1521	2	13	19
RW3021	DRA	MD	1521	2	13	19
RW3024	DRA	DR	1524	2	13	22
RW3024	DRA	GL	1524	2	13	22
RW3024	DRA	MD	1524	2	13	22
RW3312	DRA	DR	3312	2	14 1/2	10
RW3312	DRA	GL	3312	2	14 1/2	10
RW3312	DRA	MD	3312	2	14 1/2	10
RW3315	DRA	DR	3315	2	14 1/2	13
RW3315	DRA	GL	3315	2	14 1/2	13
RW3315	DRA	MD	3315	2	14 1/2	13
RW3318	DRA	DR	3318	2	14 1/2	16
RW3318	DRA	GL	3318	2	14 1/2	16
RW3318	DRA	MD	3318	2	14 1/2	16
RW3321	DRA	DR	3321	2	14 1/2	19
RW3321	DRA	GL	3321	2	14 1/2	19
RW3321	DRA	MD	3321	2	14 1/2	19
RW3324	DRA	DR	3324	2	14 1/2	22
RW3324	DRA	GL	3324	2	14 1/2	22
RW3324	DRA	MD	3324	2	14 1/2	22
RW3612	DRA	DR	1812	2	16	10
RW3612	DRA	GL	1812	2	16	10
RW3612	DRA	MD	1812	2	16	10
RW3615	DRA	DR	1815	2	16	13
RW3615	DRA	GL	1815	2	16	13
RW3615	DRA	MD	1815	2	16	13
RW3618	DRA	DR	1818	2	16	16
RW3618	DRA	GL	1818	2	16	16
RW3618	DRA	MD	1818	2	16	16
RW3621	DRA	DR	1821	2	16	19
RW3621	DRA	GL	1821	2	16	19
RW3621	DRA	MD	1821	2	16	19
RW3624	DRA	DR	1824	2	16	22
RW3624	DRA	GL	1824	2	16	22
RW3624	DRA	MD	1824	2	16	22
RW3912	DRA	DR	3912	2	17 1/2	10
RW3912	DRA	GL	3912	2	17 1/2	10
RW3912	DRA	MD	3912	2	17 1/2	10
RW3915	DRA	DR	3915	2	17 1/2	13
RW3915	DRA	GL	3915	2	17 1/2	13
RW3915	DRA	MD	3915	2	17 1/2	13
RW3918	DRA	DR	3918	2	17 1/2	16
RW3918	DRA	GL	3918	2	17 1/2	16
RW3918	DRA	MD	3918	2	17 1/2	16
RW3921	DRA	DR	3921	2	17 1/2	19
RW3921	DRA	GL	3921	2	17 1/2	19
RW3921	DRA	MD	3921	2	17 1/2	19

SUPPLEMENTAL PARTS – SOL

SKU	MAP	TYPE	PART ID	QTY	WIDTH	HEIGHT
RW3924	DRA	DR	3924	2	17 1/2	22
RW3924	DRA	GL	3924	2	17 1/2	22
RW3924	DRA	MD	3924	2	17 1/2	22
RW4212	DRA	DR	2112	2	19	10
RW4212	DRA	GL	2112	2	19	10
RW4212	DRA	MD	2112	2	19	10
RW4215	DRA	DR	2115	2	19	13
RW4215	DRA	GL	2115	2	19	13
RW4215	DRA	MD	2115	2	19	13
RW4218	DRA	DR	2118	2	19	16
RW4218	DRA	GL	2118	2	19	16
RW4218	DRA	MD	2118	2	19	16
RW4221	DRA	DR	2121	2	19	19
RW4221	DRA	GL	2121	2	19	19
RW4221	DRA	MD	2121	2	19	19
RW4224	DRA	DR	2124	2	19	22
RW4224	DRA	GL	2124	2	19	22
RW4224	DRA	MD	2124	2	19	22
RW4512BP	DRA	DR	4512BP	4	10 3/16	10
RW4512BP	DRA	GL	4512BP	4	10 3/16	10
RW4512BP	DRA	MD	4512BP	4	10 3/16	10
RW4515BP	DRA	DR	4515BP	4	10 3/16	13
RW4515BP	DRA	GL	4515BP	4	10 3/16	13
RW4515BP	DRA	MD	4515BP	4	10 3/16	13
RW4518BP	DRA	DR	4518BP	4	10 3/16	16
RW4518BP	DRA	GL	4518BP	4	10 3/16	16
RW4518BP	DRA	MD	4518BP	4	10 3/16	16
RW4521BP	DRA	DR	4521BP	4	10 3/16	19
RW4521BP	DRA	GL	4521BP	4	10 3/16	19
RW4521BP	DRA	MD	4521BP	4	10 3/16	19
RW4524BP	DRA	DR	4524BP	4	10 3/16	22
RW4524BP	DRA	GL	4524BP	4	10 3/16	22
RW4524BP	DRA	MD	4524BP	4	10 3/16	22
RW4812BP	DRA	DR	2412BP	4	10 15/16	10
RW4812BP	DRA	GL	2412BP	4	10 15/16	10
RW4812BP	DRA	MD	2412BP	4	10 15/16	10
RW4815BP	DRA	DR	2415BP	4	10 15/16	13
RW4815BP	DRA	GL	2415BP	4	10 15/16	13
RW4815BP	DRA	MD	2415BP	4	10 15/16	13
RW4818BP	DRA	DR	2418BP	4	10 15/16	16
RW4818BP	DRA	GL	2418BP	4	10 15/16	16
RW4818BP	DRA	MD	2418BP	4	10 15/16	16
RW4821BP	DRA	DR	2421BP	4	10 15/16	19
RW4821BP	DRA	GL	2421BP	4	10 15/16	19
RW4821BP	DRA	MD	2421BP	4	10 15/16	19
RW4824BP	DRA	DR	2424BP	4	10 15/16	22
RW4824BP	DRA	GL	2424BP	4	10 15/16	22
RW4824BP	DRA	MD	2424BP	4	10 15/16	22
SSB60	DRA	DR	1524	4	13	22
SSB60	DFA	DF	PB15	4	13	5 1/4
SSCB3636	DRA	DR	CB36	2	10 3/8	28
SSDCB3636	DRA	DR	CW30	1	15	28
UC158412	DRA	DR	1530	1	13	28
UC158412	DRB	DR	15UC	1	13	47 1/2
UC158424	DRA	DR	1530	1	13	28
UC158424	DRB	DR	15UC	1	13	47 1/2
UC159012	DRA	DR	1536	1	13	34
UC159012	DRB	DR	15UC	1	13	47 1/2

SUPPLEMENTAL PARTS – SOL

SKU	MAP	TYPE	PART ID	QTY	WIDTH	HEIGHT
UC159024	DRA	DR	1536	1	13	34
UC159024	DRB	DR	15UC	1	13	47 1/2
UC159612	DRA	DR	1542	1	13	40
UC159612	DRB	DR	15UC	1	13	47 1/2
UC159624	DRA	DR	1542	1	13	40
UC159624	DRB	DR	15UC	1	13	47 1/2
UC188412	DRA	DR	1830	1	16	28
UC188412	DRB	DR	18UC	1	16	47 1/2
UC188424	DRA	DR	1830	1	16	28
UC188424	DRB	DR	18UC	1	16	47 1/2
UC189012	DRA	DR	1836	1	16	34
UC189012	DRB	DR	18UC	1	16	47 1/2
UC189024	DRA	DR	1836	1	16	34
UC189024	DRB	DR	18UC	1	16	47 1/2
UC189612	DRA	DR	1842	1	16	40
UC189612	DRB	DR	18UC	1	16	47 1/2
UC189624	DRA	DR	1842	1	16	40
UC189624	DRB	DR	18UC	1	16	47 1/2
UC248412	DRA	DR	2430BP	2	10 15/16	28
UC248412	DRB	DR	24UC	2	10 15/16	47 1/2
UC248424	DRA	DR	2430BP	2	10 15/16	28
UC248424	DRB	DR	24UC	2	10 15/16	47 1/2
UC249012	DRA	DR	2436BP	2	10 15/16	34
UC249012	DRB	DR	24UC	2	10 15/16	47 1/2
UC249024	DRA	DR	2436BP	2	10 15/16	34
UC249024	DRB	DR	24UC	2	10 15/16	47 1/2
UC249612	DRA	DR	2442BP	2	10 15/16	40
UC249612	DRB	DR	24UC	2	10 15/16	47 1/2
UC249624	DRA	DR	2442BP	2	10 15/16	40
UC249624	DRB	DR	24UC	2	10 15/16	47 1/2
UC308412	DRA	DR	3030BP	2	13 15/16	28
UC308412	DRB	DR	30UC	2	13 15/16	47 1/2
UC308424	DRA	DR	3030BP	2	13 15/16	28
UC308424	DRB	DR	30UC	2	13 15/16	47 1/2
UC309012	DRA	DR	3036BP	2	13 15/16	34
UC309012	DRB	DR	30UC	2	13 15/16	47 1/2
UC309024	DRA	DR	3036BP	2	13 15/16	34
UC309024	DRB	DR	30UC	2	13 15/16	47 1/2
UC309612	DRA	DR	3042BP	2	13 15/16	40
UC309612	DRB	DR	30UC	2	13 15/16	47 1/2
UC309624	DRA	DR	3042BP	2	13 15/16	40
UC309624	DRB	DR	30UC	2	13 15/16	47 1/2
UC368412	DRA	DR	3630BP	2	16 15/16	28
UC368412	DRB	DR	36UC	2	16 15/16	47 1/2
UC368424	DRA	DR	3630BP	2	16 15/16	28
UC368424	DRB	DR	36UC	2	16 15/16	47 1/2
UC369012	DRA	DR	3636BP	2	16 15/16	34
UC369012	DRB	DR	36UC	2	16 15/16	47 1/2
UC369024	DRA	DR	3636BP	2	16 15/16	34
UC369024	DRB	DR	36UC	2	16 15/16	47 1/2
UC369612	DRA	DR	3642BP	2	16 15/16	40
UC369612	DRB	DR	36UC	2	16 15/16	47 1/2
UC369624	DRA	DR	3642BP	2	16 15/16	40
UC369624	DRB	DR	36UC	2	16 15/16	47 1/2
V3D12	DFA	DF	PB12	1	10	5 1/4
V3D12	DFB	DF	V3D12	2	10	9 1/8
V3D15	DFA	DF	PB15	1	13	5 1/4
V3D15	DFB	DF	V3D15	2	13	9 1/8

SUPPLEMENTAL PARTS – SOL

SKU	MAP	TYPE	PART ID	QTY	WIDTH	HEIGHT
V3D18	DFA	DF	PB18	1	16	5 1/4
V3D18	DFB	DF	V3D18	2	16	9 1/8
V3D21	DFA	DF	PB21	1	19	5 1/4
V3D21	DFB	DF	V3D21	2	19	9 1/8
V3D24	DFA	DF	PB24	1	22	5 1/4
V3D24	DFB	DF	V3D24	2	22	9 1/8
V3D12BH	DFA	DF	PB12	1	10	5 1/4
V3D12BH	DFB	DF	DBP12	2	10	10 1/2
V3D15BH	DFA	DF	PB15	1	13	5 1/4
V3D15BH	DFB	DF	DBP15	2	13	10 1/2
V3D18BH	DFA	DF	PB18	1	16	5 1/4
V3D18BH	DFB	DF	DBP18	2	16	10 1/2
V3D21BH	DFA	DF	PB21	1	19	5 1/4
V3D21BH	DFB	DF	DBP21	2	19	10 1/2
V3D24BH	DFA	DF	PB24	1	22	5 1/4
V3D24BH	DFB	DF	DBP24	2	22	10 1/2
V4D12BH	DFA	DF	PB12	2	10	5 1/4
V4D12BH	DFB	DF	D4B12	2	10	7 5/8
V4D15BH	DFA	DF	PB15	2	13	5 1/4
V4D15BH	DFB	DF	D4B15	2	13	7 5/8
V4D18BH	DFA	DF	PB18	2	16	5 1/4
V4D18BH	DFB	DF	D4B18	2	16	7 5/8
V4D21BH	DFA	DF	PB21	2	19	5 1/4
V4D21BH	DFB	DF	D4B21	2	19	7 5/8
V4D24BH	DFA	DF	PB24	2	22	5 1/4
V4D24BH	DFB	DF	D4B24	2	22	7 5/8
VB12	DRA	DR	1221	1	10	19
VB12	DFA	DF	PB12	1	10	5 1/4
VB12BH	DRA	DR	1224	1	10	22
VB12BH	DFA	DF	PB12	1	10	5 1/4
VB15	DRA	DR	1521	1	13	19
VB15	DFA	DF	PB15	1	13	5 1/4
VB15BH	DRA	DR	1524	1	13	22
VB15BH	DFA	DF	PB15	1	13	5 1/4
VB18	DRA	DR	1821	1	16	19
VB18	DFA	DF	PB18	1	16	5 1/4
VB18BH	DRA	DR	1824	1	16	22
VB18BH	DFA	DF	PB18	1	16	5 1/4
VB21	DRA	DR	2121	1	19	19
VB21	DFA	DF	PB21	1	19	5 1/4
VB21BH	DRA	DR	2124	1	19	22
VB21BH	DFA	DF	PB21	1	19	5 1/4
VB24	DRA	DR	2421	1	22	19
VB24	DFA	DF	PB24	1	22	5 1/4
VB24BH	DRA	DR	2424	1	22	22
VB24BH	DFA	DF	PB24	1	22	5 1/4
VB24BHBP	DRA	DR	2424BP	2	10 15/16	22
VB24BHBP	DFA	DF	PB24	1	22	5 1/4
VB24BP	DRA	DR	2421BP	2	10 15/16	19
VB24BP	DFA	DF	PB24	1	22	5 1/4
VB27	DRA	DR	2721	2	11 1/2	19
VB27	DFA	DF	PB27	2	11 1/2	5 1/4
VB27BH	DRA	DR	2724	2	11 1/2	22
VB27BH	DFA	DF	PB27	2	11 1/2	5 1/4
VB27BHBP	DRA	DR	2724BP	2	12 7/16	22
VB27BHBP	DFA	DF	PB27BP	1	25	5 1/4
VB27BP	DRA	DR	2721BP	2	12 7/16	19
VB27BP	DFA	DF	PB27BP	1	25	5 1/4

SUPPLEMENTAL PARTS – SOL

SKU	MAP	TYPE	PART ID	QTY	WIDTH	HEIGHT
VB30	DRA	DR	1521	2	13	19
VB30	DFA	DF	PB15	2	13	5 1/4
VB30BH	DRA	DR	1524	2	13	22
VB30BH	DFA	DF	PB15	2	13	5 1/4
VB30BHBP	DRA	DR	3024BP	2	13 15/16	22
VB30BHBP	DFA	DF	PB30BP	1	28	5 1/4
VB30BP	DRA	DR	3021BP	2	13 15/16	19
VB30BP	DFA	DF	PB30BP	1	28	5 1/4
VB33	DRA	DR	3321	2	14 1/2	19
VB33	DFA	DF	PB33	2	14 1/2	5 1/4
VB33BH	DRA	DR	3324	2	14 1/2	22
VB33BH	DFA	DF	PB33	2	14 1/2	5 1/4
VB33BHBP	DRA	DR	3324BP	2	15 7/16	22
VB33BHBP	DFA	DF	PB33BP	1	31	5 1/4
VB33BP	DRA	DR	3321BP	2	15 7/16	19
VB33BP	DFA	DF	PB33BP	1	31	5 1/4
VB36	DRA	DR	1821	2	16	19
VB36	DFA	DF	PB18	2	16	5 1/4
VB36BH	DRA	DR	1824	2	16	22
VB36BH	DFA	DF	PB18	2	16	5 1/4
VB36BHBP	DRA	DR	3624BP	2	16 15/16	22
VB36BHBP	DFA	DF	PB36BP	1	34	5 1/4
VB36BP	DRA	DR	3621BP	2	16 15/16	19
VB36BP	DFA	DF	PB36BP	1	34	5 1/4
VB39	DRA	DR	3921	2	17 1/2	19
VB39	DFA	DF	PB39	2	17 1/2	5 1/4
VB39BH	DRA	DR	3924	2	17 1/2	22
VB39BH	DFA	DF	PB39	2	17 1/2	5 1/4
VB42	DRA	DR	2121	2	19	19
VB42	DFA	DF	PB21	2	19	5 1/4
VB42BH	DRA	DR	2124	2	19	22
VB42BH	DFA	DF	PB21	2	19	5 1/4
VB45BHBP	DRA	DR	4524BP	4	10 3/16	22
VB45BHBP	DFA	DF	PB45	2	20 1/2	5 1/4
VB45BP	DRA	DR	4521BP	4	10 3/16	19
VB45BP	DFA	DF	PB45	2	20 1/2	5 1/4
VB48BHBP	DRA	DR	2424BP	4	10 15/16	22
VB48BHBP	DFA	DF	PB24	2	22	5 1/4
VB48BP	DRA	DR	2421BP	4	10 15/16	19
VB48BP	DFA	DF	PB24	2	22	5 1/4
VB9	DRA	DR	921	1	7	19
VB9	DFA	DF	PB9	1	7	5 1/4
VB9BH	DRA	DR	924	1	7	22
VB9BH	DFA	DF	PB9	1	7	5 1/4
VDL33	DRA	DR	3321	2	14 1/2	19
VDL33	DFA	DF	PB9	2	7	5 1/4
VDL33	DFB	DF	PB15	1	13	5 1/4
VDL33BH	DRA	DR	3324	2	14 1/2	22
VDL33BH	DFA	DF	PB9	2	7	5 1/4
VDL33BH	DFB	DF	PB15	1	13	5 1/4
VDL36	DRA	DR	1821	2	16	19
VDL36	DFA	DF	PB9	2	7	5 1/4
VDL36	DFB	DF	PB18	1	16	5 1/4
VDL36BH	DRA	DR	1824	2	16	22
VDL36BH	DFA	DF	PB9	2	7	5 1/4
VDL36BH	DFB	DF	PB18	1	16	5 1/4

SUPPLEMENTAL PARTS – SOL

SKU	MAP	TYPE	PART ID	QTY	WIDTH	HEIGHT
VDL39	DRA	DR	3921	2	17 1/2	19
VDL39	DFA	DF	PB9	2	7	5 1/4
VDL39	DFB	DF	PB21	1	19	5 1/4
VDL39BH	DRA	DR	3924	2	17 1/2	22
VDL39BH	DFA	DF	PB9	2	7	5 1/4
VDL39BH	DFB	DF	PB21	1	19	5 1/4
VDL42	DRA	DR	2121	2	19	19
VDL42	DFA	DF	PB12	2	10	5 1/4
VDL42	DFB	DF	PB18	1	16	5 1/4
VDL42BH	DRA	DR	2124	2	19	22
VDL42BH	DFA	DF	PB12	2	10	5 1/4
VDL42BH	DFB	DF	PB18	1	16	5 1/4
VDL45	DRA	DR	4521	2	20 1/2	19
VDL45	DFA	DF	PB12	2	10	5 1/4
VDL45	DFB	DF	PB21	1	19	5 1/4
VDL45BH	DRA	DR	4524	2	20 1/2	22
VDL45BH	DFA	DF	PB12	2	10	5 1/4
VDL45BH	DFB	DF	PB21	1	19	5 1/4
VDL48	DRA	DR	2421	2	22	19
VDL48	DFA	DF	PB15	2	13	5 1/4
VDL48	DFB	DF	PB18	1	16	5 1/4
VDL48BH	DRA	DR	2424	2	22	22
VDL48BH	DFA	DF	PB15	2	13	5 1/4
VDL48BH	DFB	DF	PB18	1	16	5 1/4
VDL54BHBP	DRA	DR	2424BP	2	10 15/16	22
VDL54BHBP	DRB	DR	1524	2	13	22
VDL54BHBP	DFA	DF	PB15	2	13	5 1/4
VDL54BHBP	DFB	DF	PB24	1	22	5 1/4
VDL54BP	DRA	DR	2421BP	2	10 15/16	19
VDL54BP	DRB	DR	1521	2	13	19
VDL54BP	DFA	DF	PB15	2	13	5 1/4
VDL54BP	DFB	DF	PB24	1	22	5 1/4
VDL58	DRA	DR	2427BP	4	10 15/16	25
VDL58	DFA	DF	PB12	1	10	5 1/4
VDL58	DFB	DF	VD12	2	10	9 1/8
VDL58BH	DRA	DR	2424BP	4	10 15/16	22
VDL58BH	DFA	DF	PB24	2	22	5 1/4
VDL58BH	DFB	DF	PB12	2	10	5 1/4
VDL58BH	DFC	DF	DB12	2	10	7 5/8
VDL60BHBP	DRA	DR	2424BP	2	10 15/16	22
VDL60BHBP	DRB	DR	1824	2	16	22
VDL60BHBP	DFA	DF	PB18	2	16	5 1/4
VDL60BHBP	DFB	DF	PB24	1	22	5 1/4
VDL60BP	DRA	DR	2421BP	2	10 15/16	19
VDL60BP	DRB	DR	1821	2	16	19
VDL60BP	DFA	DF	PB18	2	16	5 1/4
VDL60BP	DFB	DF	PB24	1	22	5 1/4
VDL72	DRA	DR	1821	4	16	19
VDL72	DFA	DF	PB18	4	16	5 1/4
VDL72BH	DRA	DR	1824	4	16	22
VDL72BH	DFA	DF	PB18	4	16	5 1/4
VDU36	DFA	DF	PB24	1	22	5 1/4
VFD18	DFA	DF	PB18	2	16	5 1/4
VFD18	DFB	DF	VFD18	1	16	13
VFD18BH	DFA	DF	D2B18	2	16	13 7/16
VFD21	DFA	DF	PB18	2	19	5 1/4
VFD21	DFB	DF	VFD21	1	19	13
VFD21BH	DFA	DF	D2B21	2	19	13 7/16

SUPPLEMENTAL PARTS – SOL

SKU	MAP	TYPE	PART ID	QTY	WIDTH	HEIGHT
VFH12	DRA	DR	1227	1	10	25
VFH12BH	DRA	DR	1230	1	10	28
VFH15	DRA	DR	1527	1	13	25
VFH15BH	DRA	DR	1530	1	13	28
VFH18	DRA	DR	1827	1	16	25
VFH1816	DRA	DR	1827	1	16	25
VFH18BH	DRA	DR	1830	1	16	28
VFH21	DRA	DR	2127	1	19	25
VFH21BH	DRA	DR	2130	1	19	28
VFH2418	DRA	DR	2427BP	2	10 15/16	25
VFH24BHBP	DRA	DR	2430BP	2	10 15/16	28
VFH24BP	DRA	DR	2427BP	2	10 15/16	25
VFH27	DRA	DR	2727	2	11 1/2	25
VFH27BH	DRA	DR	2730	2	11 1/2	28
VFH27BHBP	DRA	DR	2730BP	2	12 7/16	28
VFH27BP	DRA	DR	2727BP	2	12 7/16	25
VFH30	DRA	DR	1527	2	13	25
VFH3018	DRA	DR	1527	2	13	25
VFH30BH	DRA	DR	1530	2	13	28
VFH30BHBP	DRA	DR	3030BP	2	13 15/16	28
VFH30BP	DRA	DR	3027BP	2	13 15/16	25
VFH33	DRA	DR	3327	2	14 1/2	25
VFH3318	DRA	DR	3327	2	14 1/2	25
VFH33BH	DRA	DR	3330	2	14 1/2	28
VFH33BHBP	DRA	DR	3330BP	2	15 7/16	28
VFH33BP	DRA	DR	3327BP	2	15 7/16	25
VFH36	DRA	DR	1827	2	16	25
VFH3618	DRA	DR	1827	2	16	25
VFH36BH	DRA	DR	1830	2	16	28
VFH36BHBP	DRA	DR	3630BP	2	16 15/16	28
VFH36BP	DRA	DR	3627BP	2	16 15/16	25
VFH39BHBP	DRA	DR	3930BP	2	18 7/16	28
VFH39BP	DRA	DR	3927BP	2	18 7/16	25
VFH42	DRA	DR	2127	2	19	25
VFH42BH	DRA	DR	2130	2	19	28
VFH42BHBP	DRA	DR	4230BP	2	19 15/16	28
VFH42BP	DRA	DR	4227BP	2	19 15/16	25
VFH45BHBP	DRA	DR	4530BP	4	10 3/16	28
VFH45BP	DRA	DR	4527BP	4	10 3/16	25
VFH48BHBP	DRA	DR	2430BP	4	10 15/16	28
VFH48BP	DRA	DR	2427BP	4	10 15/16	25
VFH54BHBP	DRA	DR	2730BP	4	12 7/16	28
VFH54BP	DRA	DR	2727BP	4	12 7/16	25
VFH60BHBP	DRA	DR	3030BP	4	13 15/16	28
VFH60BP	DRA	DR	3027BP	4	13 15/16	25
VFH72	DRA	DR	1827	4	16	25
VFH72BH	DRA	DR	1830	4	16	28
VFH9	DRA	DR	927	1	7	25
VFH9BH	DRA	DR	930	1	7	28
VLF24	DRA	DR	2427BP	2	10 15/16	25
VLF30	DRA	DR	1527	2	13	25
VLF36	DRA	DR	1827	2	16	25
VS18	DRA	DR	1821	1	16	19
VS18	DFA	DF	PB18	1	16	5 1/4
VS18BH	DRA	DR	1824	1	16	22
VS18BH	DFA	DF	PB18	1	16	5 1/4
VS21	DRA	DR	2121	1	19	19
VS21	DFA	DF	PB21	1	19	5 1/4

SUPPLEMENTAL PARTS – SOL

SKU	MAP	TYPE	PART ID	QTY	WIDTH	HEIGHT
VS21BH	DRA	DR	2124	1	19	22
VS21BH	DFA	DF	PB21	1	19	5 1/4
VS24	DRA	DR	2421	1	22	19
VS24	DFA	DF	PB24	1	22	5 1/4
VS24BH	DRA	DR	2424	1	22	22
VS24BH	DFA	DF	PB24	1	22	5 1/4
VS24BHBP	DRA	DR	2424BP	2	10 15/16	22
VS24BHBP	DFA	DF	PB24	1	22	5 1/4
VS24BP	DRA	DR	2421BP	2	10 15/16	19
VS24BP	DFA	DF	PB24	1	22	5 1/4
VS27	DRA	DR	2721	2	11 1/2	19
VS27	DFA	DF	PB27	2	11 1/2	5 1/4
VS27BH	DRA	DR	2724	2	11 1/2	22
VS27BH	DFA	DF	PB27	2	11 1/2	5 1/4
VS27BHBP	DRA	DR	2724BP	2	12 7/16	22
VS27BHBP	DFA	DF	PB27BP	1	25	5 1/4
VS27BP	DRA	DR	2721BP	2	12 7/16	19
VS27BP	DFA	DF	PB27BP	1	25	5 1/4
VS30	DRA	DR	1521	2	13	19
VS30	DFA	DF	PB15	2	13	5 1/4
VS30BH	DRA	DR	1524	2	13	22
VS30BH	DFA	DF	PB15	2	13	5 1/4
VS30BHBP	DRA	DR	3024BP	2	13 15/16	22
VS30BHBP	DFA	DF	PB30BP	1	28	5 1/4
VS30BP	DRA	DR	3021BP	2	13 15/16	19
VS30BP	DFA	DF	PB30BP	1	28	5 1/4
VS33	DRA	DR	3321	2	14 1/2	19
VS33	DFA	DF	PB33	2	14 1/2	5 1/4
VS33BH	DRA	DR	3324	2	14 1/2	22
VS33BH	DFA	DF	PB33	2	14 1/2	5 1/4
VS33BHBP	DRA	DR	3324BP	2	15 7/16	22
VS33BHBP	DFA	DF	PB33BP	1	31	5 1/4
VS33BP	DRA	DR	3321BP	2	15 7/16	19
VS33BP	DFA	DF	PB33BP	1	31	5 1/4
VS36	DRA	DR	1821	2	16	19
VS36	DFA	DF	PB18	2	16	5 1/4
VS36BH	DRA	DR	1824	2	16	22
VS36BH	DFA	DF	PB18	2	16	5 1/4
VS36BHBP	DRA	DR	3624BP	2	16 15/16	22
VS36BHBP	DFA	DF	PB36BP	1	34	5 1/4
VS36BP	DRA	DR	3621BP	2	16 15/16	19
VS36BP	DFA	DF	PB36BP	1	34	5 1/4
VS39	DRA	DR	3921	2	17 1/2	19
VS39	DFA	DF	PB39	2	17 1/2	5 1/4
VS39BH	DRA	DR	3924	2	17 1/2	22
VS39BH	DFA	DF	PB39	2	17 1/2	5 1/4
VS42	DRA	DR	2121	2	19	19
VS42	DFA	DF	PB21	2	19	5 1/4
VS42BH	DRA	DR	2124	2	19	22
VS42BH	DFA	DF	PB21	2	19	5 1/4
VS45BHBP	DRA	DR	4524BP	4	10 3/16	22
VS45BHBP	DFA	DF	PB45	2	20 1/2	5 1/4
VS45BP	DRA	DR	4521BP	4	10 3/16	19
VS45BP	DFA	DF	PB45	2	20 1/2	5 1/4
VS48BHBP	DRA	DR	2424BP	4	10 15/16	22
VS48BHBP	DFA	DF	PB24	2	22	5 1/4
VS48BP	DRA	DR	2421BP	4	10 15/16	19
VS48BP	DFA	DF	PB24	2	22	5 1/4

SUPPLEMENTAL PARTS – SOL

SKU	MAP	TYPE	PART ID	QTY	WIDTH	HEIGHT
VSD30BHLH	DRA	DR	1824	1	16	22
VSD30BHLH	DFA	DF	PB18	1	16	5 1/4
VSD30BHLH	DFB	DF	PB12	2	10	5 1/4
VSD30BHLH	DFC	DF	DB12	2	10	7 5/8
VSD30BHRH	DRA	DR	1824	1	16	22
VSD30BHRH	DFA	DF	PB18	1	16	5 1/4
VSD30BHRH	DFB	DF	PB12	2	10	5 1/4
VSD30BHRH	DFC	DF	DB12	2	10	7 5/8
VSD30LH	DRA	DR	1827	1	16	25
VSD30LH	DFA	DF	VD12	2	10	9 1/8
VSD30LH	DFB	DF	PB12	1	10	5 1/4
VSD30RH	DRA	DR	1827	1	16	25
VSD30RH	DFA	DF	VD12	2	10	9 1/8
VSD30RH	DFB	DF	PB12	1	10	5 1/4
VSD36BHLH	DRA	DR	2124	1	19	22
VSD36BHLH	DFA	DF	PB21	1	19	5 1/4
VSD36BHLH	DFB	DF	PB15	2	13	5 1/4
VSD36BHLH	DFC	DF	DB15	2	13	7 5/8
VSD36BHRH	DRA	DR	2124	1	19	22
VSD36BHRH	DFA	DF	PB21	1	19	5 1/4
VSD36BHRH	DFB	DF	PB15	2	13	5 1/4
VSD36BHRH	DFC	DF	DB15	2	13	7 5/8
VSD36LH	DRA	DR	2127	1	19	25
VSD36LH	DFA	DF	PB15	1	13	5 1/4
VSD36LH	DFB	DF	VD15	2	13	9 1/8
VSD36RH	DRA	DR	2127	1	19	25
VSD36RH	DFA	DF	PB15	1	13	5 1/4
VSD36RH	DFB	DF	VD15	2	13	9 1/8
VWC156	DRA	DR	1530	1	13	28
VWC2436	DRA	DR	2424BP	2	10 15/16	22
WC1224	DRA	DR	1224	1	10	22
WC1224	DRA	GL	1224	1	10	22
WC1224	DRA	MD	1224	1	10	22
WC1230	DRA	DR	1230	1	10	28
WC1230	DRA	GL	1230	1	10	28
WC1230	DRA	MD	1230	1	10	28
WC1236	DRA	DR	1236	1	10	34
WC1236	DRA	GL	1236	1	10	34
WC1236	DRA	MD	1236	1	10	34
WC1242	DRA	DR	1242	1	10	40
WC1242	DRA	GL	1242	1	10	40
WC1242	DRA	MD	1242	1	10	40
WC1524	DRA	DR	1524	1	13	22
WC1524	DRA	GL	1524	1	13	22
WC1524	DRA	MD	1524	1	13	22
WC1530	DRA	DR	1530	1	13	28
WC1530	DRA	GL	1530	1	13	28
WC1530	DRA	MD	1530	1	13	28
WC1536	DRA	DR	1536	1	13	34
WC1536	DRA	GL	1536	1	13	34
WC1536	DRA	MD	1536	1	13	34
WC1542	DRA	DR	1542	1	13	40
WC1542	DRA	GL	1542	1	13	40
WC1542	DRA	MD	1542	1	13	40
WC1824	DRA	DR	1824	1	16	22
WC1824	DRA	GL	1824	1	16	22
WC1824	DRA	MD	1824	1	16	22

SUPPLEMENTAL PARTS – SOL

SKU	MAP	TYPE	PART ID	QTY	WIDTH	HEIGHT
WC1830	DRA	DR	1830	1	16	28
WC1830	DRA	GL	1830	1	16	28
WC1830	DRA	MD	1830	1	16	28
WC1836	DRA	DR	1836	1	16	34
WC1836	DRA	GL	1836	1	16	34
WC1836	DRA	MD	1836	1	16	34
WC1842	DRA	DR	1842	1	16	40
WC1842	DRA	GL	1842	1	16	40
WC1842	DRA	MD	1842	1	16	40
WC2118	DRA	DR	2118	1	19	16
WC2118	DRA	GL	2118	1	19	16
WC2118	DRA	MD	2118	1	19	16
WC2124	DRA	DR	2124	1	19	22
WC2124	DRA	GL	2124	1	19	22
WC2124	DRA	MD	2124	1	19	22
WC2130	DRA	DR	2130	1	19	28
WC2130	DRA	GL	2130	1	19	28
WC2130	DRA	MD	2130	1	19	28
WC2136	DRA	DR	2136	1	19	34
WC2136	DRA	GL	2136	1	19	34
WC2136	DRA	MD	2136	1	19	34
WC2142	DRA	DR	2142	1	19	40
WC2142	DRA	GL	2142	1	19	40
WC2142	DRA	MD	2142	1	19	40
WC2418	DRA	DR	2418	1	22	16
WC2418	DRA	GL	2418	1	22	16
WC2418	DRA	MD	2418	1	22	16
WC2418BP	DRA	DR	2418BP	2	10 15/16	16
WC2418BP	DRA	GL	2418BP	2	10 15/16	16
WC2418BP	DRA	MD	2418BP	2	10 15/16	16
WC2424	DRA	DR	2424	1	22	22
WC2424	DRA	GL	2424	1	22	22
WC2424	DRA	MD	2424	1	22	22
WC2424BP	DRA	DR	2424BP	2	10 15/16	22
WC2424BP	DRA	GL	2424BP	2	10 15/16	22
WC2424BP	DRA	MD	2424BP	2	10 15/16	22
WC2430	DRA	DR	2430	1	22	28
WC2430	DRA	GL	2430	1	22	28
WC2430	DRA	MD	2430	1	22	28
WC2430BP	DRA	DR	2430BP	2	10 15/16	28
WC2430BP	DRA	GL	2430BP	2	10 15/16	28
WC2430BP	DRA	MD	2430BP	2	10 15/16	28
WC2436	DRA	DR	2436	1	22	34
WC2436	DRA	GL	2436	1	22	34
WC2436	DRA	MD	2436	1	22	34
WC2436BP	DRA	DR	2436BP	2	10 15/16	34
WC2436BP	DRA	GL	2436BP	2	10 15/16	34
WC2436BP	DRA	MD	2436BP	2	10 15/16	34
WC2442	DRA	DR	2442	1	22	40
WC2442	DRA	GL	2442	1	22	40
WC2442	DRA	MD	2442	1	22	40
WC2442BP	DRA	DR	2442BP	2	10 15/16	40
WC2442BP	DRA	GL	2442BP	2	10 15/16	40
WC2442BP	DRA	MD	2442BP	2	10 15/16	40
WC2718	DRA	DR	2718	2	11 1/2	16
WC2718	DRA	GL	2718	2	11 1/2	16
WC2718	DRA	MD	2718	2	11 1/2	16

SUPPLEMENTAL PARTS – SOL

SKU	MAP	TYPE	PART ID	QTY	WIDTH	HEIGHT
WC2718BP	DRA	DR	2718BP	2	12 7/16	16
WC2718BP	DRA	GL	2718BP	2	12 7/16	16
WC2718BP	DRA	MD	2718BP	2	12 7/16	16
WC2724	DRA	DR	2724	2	11 1/2	22
WC2724	DRA	GL	2724	2	11 1/2	22
WC2724	DRA	MD	2724	2	11 1/2	22
WC2724BP	DRA	DR	2724BP	2	12 7/16	22
WC2724BP	DRA	GL	2724BP	2	12 7/16	22
WC2724BP	DRA	MD	2724BP	2	12 7/16	22
WC2730	DRA	DR	2730	2	11 1/2	28
WC2730	DRA	GL	2730	2	11 1/2	28
WC2730	DRA	MD	2730	2	11 1/2	28
WC2730BP	DRA	DR	2730BP	2	12 7/16	28
WC2730BP	DRA	GL	2730BP	2	12 7/16	28
WC2730BP	DRA	MD	2730BP	2	12 7/16	28
WC2736	DRA	DR	2736	2	11 1/2	34
WC2736	DRA	GL	2736	2	11 1/2	34
WC2736	DRA	MD	2736	2	11 1/2	34
WC2736BP	DRA	DR	2736BP	2	12 7/16	34
WC2736BP	DRA	GL	2736BP	2	12 7/16	34
WC2736BP	DRA	MD	2736BP	2	12 7/16	34
WC2742	DRA	DR	2742	2	11 1/2	40
WC2742	DRA	GL	2742	2	11 1/2	40
WC2742	DRA	MD	2742	2	11 1/2	40
WC2742BP	DRA	DR	2742BP	2	12 7/16	40
WC2742BP	DRA	GL	2742BP	2	12 7/16	40
WC2742BP	DRA	MD	2742BP	2	12 7/16	40
WC3012	DRA	DR	1512	2	13	10
WC3012	DRA	GL	1512	2	13	10
WC3012	DRA	MD	1512	2	13	10
WC3012BP	DRA	DR	3012BP	2	13 15/16	10
WC3012BP	DRA	GL	3012BP	2	13 15/16	10
WC3012BP	DRA	MD	3012BP	2	13 15/16	10
WC3015	DRA	DR	1515	2	13	13
WC3015	DRA	GL	1515	2	13	13
WC3015	DRA	MD	1515	2	13	13
WC3015BP	DRA	DR	3015BP	2	13 15/16	13
WC3015BP	DRA	GL	3015BP	2	13 15/16	13
WC3015BP	DRA	MD	3015BP	2	13 15/16	13
WC3018	DRA	DR	1518	2	13	16
WC3018	DRA	GL	1518	2	13	16
WC3018	DRA	MD	1518	2	13	16
WC3018BP	DRA	DR	3018BP	2	13 15/16	16
WC3018BP	DRA	GL	3018BP	2	13 15/16	16
WC3018BP	DRA	MD	3018BP	2	13 15/16	16
WC3021	DRA	DR	1521	2	13	19
WC3021	DRA	GL	1521	2	13	19
WC3021	DRA	MD	1521	2	13	19
WC3021BP	DRA	DR	3021BP	2	13 15/16	19
WC3021BP	DRA	GL	3021BP	2	13 15/16	19
WC3021BP	DRA	MD	3021BP	2	13 15/16	19
WC3024	DRA	DR	1524	2	13	22
WC3024	DRA	GL	1524	2	13	22
WC3024	DRA	MD	1524	2	13	22
WC3024BP	DRA	DR	3024BP	2	13 15/16	22
WC3024BP	DRA	GL	3024BP	2	13 15/16	22
WC3024BP	DRA	MD	3024BP	2	13 15/16	22

SUPPLEMENTAL PARTS – SOL

SKU	MAP	TYPE	PART ID	QTY	WIDTH	HEIGHT
WC3027	DRA	DR	1527	2	13	25
WC3027	DRA	GL	1527	2	13	25
WC3027	DRA	MD	1527	2	13	25
WC3030	DRA	DR	1530	2	13	28
WC3030	DRA	GL	1530	2	13	28
WC3030	DRA	MD	1530	2	13	28
WC3030BP	DRA	DR	3030BP	2	13 15/16	28
WC3030BP	DRA	GL	3030BP	2	13 15/16	28
WC3030BP	DRA	MD	3030BP	2	13 15/16	28
WC3036	DRA	DR	1536	2	13	34
WC3036	DRA	GL	1536	2	13	34
WC3036	DRA	MD	1536	2	13	34
WC3036BP	DRA	DR	3036BP	2	13 15/16	34
WC3036BP	DRA	GL	3036BP	2	13 15/16	34
WC3036BP	DRA	MD	3036BP	2	13 15/16	34
WC3042	DRA	DR	1542	2	13	40
WC3042	DRA	GL	1542	2	13	40
WC3042	DRA	MD	1542	2	13	40
WC3042BP	DRA	DR	3042BP	2	13 15/16	40
WC3042BP	DRA	GL	3042BP	2	13 15/16	40
WC3042BP	DRA	MD	3042BP	2	13 15/16	40
WC3312	DRA	DR	3312	2	14 1/2	10
WC3312	DRA	GL	3312	2	14 1/2	10
WC3312	DRA	MD	3312	2	14 1/2	10
WC3312BP	DRA	DR	3312BP	2	15 7/16	10
WC3312BP	DRA	GL	3312BP	2	15 7/16	10
WC3312BP	DRA	MD	3312BP	2	15 7/16	10
WC3315	DRA	DR	3315	2	14 1/2	13
WC3315	DRA	GL	3315	2	14 1/2	13
WC3315	DRA	MD	3315	2	14 1/2	13
WC3315BP	DRA	DR	3315BP	2	15 7/16	13
WC3315BP	DRA	GL	3315BP	2	15 7/16	13
WC3315BP	DRA	MD	3315BP	2	15 7/16	13
WC3318	DRA	DR	3318	2	14 1/2	16
WC3318	DRA	GL	3318	2	14 1/2	16
WC3318	DRA	MD	3318	2	14 1/2	16
WC3318BP	DRA	DR	3318BP	2	15 7/16	16
WC3318BP	DRA	GL	3318BP	2	15 7/16	16
WC3318BP	DRA	MD	3318BP	2	15 7/16	16
WC3321	DRA	DR	3321	2	14 1/2	19
WC3321	DRA	GL	3321	2	14 1/2	19
WC3321	DRA	MD	3321	2	14 1/2	19
WC3321BP	DRA	DR	3321BP	2	15 7/16	19
WC3321BP	DRA	GL	3321BP	2	15 7/16	19
WC3321BP	DRA	MD	3321BP	2	15 7/16	19
WC3324	DRA	DR	3324	2	14 1/2	22
WC3324	DRA	GL	3324	2	14 1/2	22
WC3324	DRA	MD	3324	2	14 1/2	22
WC3324BP	DRA	DR	3324BP	2	15 7/16	22
WC3324BP	DRA	GL	3324BP	2	15 7/16	22
WC3324BP	DRA	MD	3324BP	2	15 7/16	22
WC3330	DRA	DR	3330	2	14 1/2	28
WC3330	DRA	GL	3330	2	14 1/2	28
WC3330	DRA	MD	3330	2	14 1/2	28
WC3330BP	DRA	DR	3330BP	2	15 7/16	28
WC3330BP	DRA	GL	3330BP	2	15 7/16	28
WC3330BP	DRA	MD	3330BP	2	15 7/16	28

SUPPLEMENTAL PARTS – SOL

SKU	MAP	TYPE	PART ID	QTY	WIDTH	HEIGHT
WC3336	DRA	DR	3336	2	14 1/2	34
WC3336	DRA	GL	3336	2	14 1/2	34
WC3336	DRA	MD	3336	2	14 1/2	34
WC3336BP	DRA	DR	3336BP	2	15 7/16	34
WC3336BP	DRA	GL	3336BP	2	15 7/16	34
WC3336BP	DRA	MD	3336BP	2	15 7/16	34
WC3342	DRA	DR	3342	2	14 1/2	40
WC3342	DRA	GL	3342	2	14 1/2	40
WC3342	DRA	MD	3342	2	14 1/2	40
WC3342BP	DRA	DR	3342BP	2	15 7/16	40
WC3342BP	DRA	GL	3342BP	2	15 7/16	40
WC3342BP	DRA	MD	3342BP	2	15 7/16	40
WC3612	DRA	DR	1812	2	16	10
WC3612	DRA	GL	1812	2	16	10
WC3612	DRA	MD	1812	2	16	10
WC3612BP	DRA	DR	3612BP	2	16 15/16	10
WC3612BP	DRA	GL	3612BP	2	16 15/16	10
WC3612BP	DRA	MD	3612BP	2	16 15/16	10
WC3615	DRA	DR	1815	2	16	13
WC3615	DRA	GL	1815	2	16	13
WC3615	DRA	MD	1815	2	16	13
WC3615BP	DRA	DR	3615BP	2	16 15/16	13
WC3615BP	DRA	GL	3615BP	2	16 15/16	13
WC3615BP	DRA	MD	3615BP	2	16 15/16	13
WC3618	DRA	DR	1818	2	16	16
WC3618	DRA	GL	1818	2	16	16
WC3618	DRA	MD	1818	2	16	16
WC3618BP	DRA	DR	3618BP	2	16 15/16	16
WC3618BP	DRA	GL	3618BP	2	16 15/16	16
WC3618BP	DRA	MD	3618BP	2	16 15/16	16
WC3621	DRA	DR	1821	2	16	19
WC3621	DRA	GL	1821	2	16	19
WC3621	DRA	MD	1821	2	16	19
WC3621BP	DRA	DR	3621BP	2	16 15/16	19
WC3621BP	DRA	GL	3621BP	2	16 15/16	19
WC3621BP	DRA	MD	3621BP	2	16 15/16	19
WC3624	DRA	DR	1824	2	16	22
WC3624	DRA	GL	1824	2	16	22
WC3624	DRA	MD	1824	2	16	22
WC3624BP	DRA	DR	3624BP	2	16 15/16	22
WC3624BP	DRA	GL	3624BP	2	16 15/16	22
WC3624BP	DRA	MD	3624BP	2	16 15/16	22
WC3630	DRA	DR	1830	2	16	28
WC3630	DRA	GL	1830	2	16	28
WC3630	DRA	MD	1830	2	16	28
WC3630BP	DRA	DR	3630BP	2	16 15/16	28
WC3630BP	DRA	GL	3630BP	2	16 15/16	28
WC3630BP	DRA	MD	3630BP	2	16 15/16	28
WC3636	DRA	DR	1836	2	16	34
WC3636	DRA	GL	1836	2	16	34
WC3636	DRA	MD	1836	2	16	34
WC3636BP	DRA	DR	3636BP	2	16 15/16	34
WC3636BP	DRA	GL	3636BP	2	16 15/16	34
WC3636BP	DRA	MD	3636BP	2	16 15/16	34
WC3642	DRA	DR	1842	2	16	40
WC3642	DRA	GL	1842	2	16	40
WC3642	DRA	MD	1842	2	16	40

SUPPLEMENTAL PARTS – SOL

SKU	MAP	TYPE	PART ID	QTY	WIDTH	HEIGHT
WC3642BP	DRA	DR	3642BP	2	16 15/16	40
WC3642BP	DRA	GL	3642BP	2	16 15/16	40
WC3642BP	DRA	MD	3642BP	2	16 15/16	40
WC3912	DRA	DR	3912	2	17 1/2	10
WC3912	DRA	GL	3912	2	17 1/2	10
WC3912	DRA	MD	3912	2	17 1/2	10
WC3912BP	DRA	DR	3912BP	2	18 7/16	10
WC3912BP	DRA	GL	3912BP	2	18 7/16	10
WC3912BP	DRA	MD	3912BP	2	18 7/16	10
WC3915	DRA	DR	3915	2	17 1/2	13
WC3915	DRA	GL	3915	2	17 1/2	13
WC3915	DRA	MD	3915	2	17 1/2	13
WC3915BP	DRA	DR	3915BP	2	18 7/16	13
WC3915BP	DRA	GL	3915BP	2	18 7/16	13
WC3915BP	DRA	MD	3915BP	2	18 7/16	13
WC3918	DRA	DR	3918	2	17 1/2	16
WC3918	DRA	GL	3918	2	17 1/2	16
WC3918	DRA	MD	3918	2	17 1/2	16
WC3918BP	DRA	DR	3918BP	2	18 7/16	16
WC3918BP	DRA	GL	3918BP	2	18 7/16	16
WC3918BP	DRA	MD	3918BP	2	18 7/16	16
WC3921	DRA	DR	3921	2	17 1/2	19
WC3921	DRA	GL	3921	2	17 1/2	19
WC3921	DRA	MD	3921	2	17 1/2	19
WC3921BP	DRA	DR	3921BP	2	18 7/16	19
WC3921BP	DRA	GL	3921BP	2	18 7/16	19
WC3921BP	DRA	MD	3921BP	2	18 7/16	19
WC3924	DRA	DR	3924	2	17 1/2	22
WC3924	DRA	GL	3924	2	17 1/2	22
WC3924	DRA	MD	3924	2	17 1/2	22
WC3924BP	DRA	DR	3924BP	2	18 7/16	22
WC3924BP	DRA	GL	3924BP	2	18 7/16	22
WC3924BP	DRA	MD	3924BP	2	18 7/16	22
WC3930	DRA	DR	3930	2	17 1/2	28
WC3930	DRA	GL	3930	2	17 1/2	28
WC3930	DRA	MD	3930	2	17 1/2	28
WC3936	DRA	DR	3936	2	17 1/2	34
WC3936	DRA	GL	3936	2	17 1/2	34
WC3936	DRA	MD	3936	2	17 1/2	34
WC3942	DRA	DR	3942	2	17 1/2	40
WC3942	DRA	GL	3942	2	17 1/2	40
WC3942	DRA	MD	3942	2	17 1/2	40
WC4218	DRA	DR	2118	2	19	16
WC4218	DRA	GL	2118	2	19	16
WC4218	DRA	MD	2118	2	19	16
WC4224	DRA	DR	2124	2	19	22
WC4224	DRA	GL	2124	2	19	22
WC4224	DRA	MD	2124	2	19	22
WC4230	DRA	DR	2130	2	19	28
WC4230	DRA	GL	2130	2	19	28
WC4230	DRA	MD	2130	2	19	28
WC4236	DRA	DR	2136	2	19	34
WC4236	DRA	GL	2136	2	19	34
WC4236	DRA	MD	2136	2	19	34
WC4242	DRA	DR	2142	2	19	40
WC4242	DRA	GL	2142	2	19	40
WC4242	DRA	MD	2142	2	19	40

SUPPLEMENTAL PARTS – SOL

SKU	MAP	TYPE	PART ID	QTY	WIDTH	HEIGHT
WC4524	DRA	DR	4524	2	20 1/2	22
WC4524	DRA	GL	4524	2	20 1/2	22
WC4524	DRA	MD	4524	2	20 1/2	22
WC4530	DRA	DR	4530	2	20 1/2	28
WC4530	DRA	GL	4530	2	20 1/2	28
WC4530	DRA	MD	4530	2	20 1/2	28
WC4536	DRA	DR	4536	2	20 1/2	34
WC4536	DRA	GL	4536	2	20 1/2	34
WC4536	DRA	MD	4536	2	20 1/2	34
WC4542	DRA	DR	4542	2	20 1/2	40
WC4542	DRA	GL	4542	2	20 1/2	40
WC4542	DRA	MD	4542	2	20 1/2	40
WC4824	DRA	DR	2424	2	22	22
WC4824	DRA	GL	2424	2	22	22
WC4824	DRA	MD	2424	2	22	22
WC4830	DRA	DR	2430	2	22	28
WC4830	DRA	GL	2430	2	22	28
WC4830	DRA	MD	2430	2	22	28
WC4836	DRA	DR	2436	2	22	34
WC4836	DRA	GL	2436	2	22	34
WC4836	DRA	MD	2436	2	22	34
WC4842	DRA	DR	2442	2	22	40
WC4842	DRA	GL	2442	2	22	40
WC4842	DRA	MD	2442	2	22	40
WC924	DRA	DR	924	1	7	22
WC924	DRA	GL	924	1	7	22
WC930	DRA	DR	930	1	7	28
WC930	DRA	GL	930	1	7	28
WC936	DRA	DR	936	1	7	34
WC936	DRA	GL	936	1	7	34
WC942	DRA	DR	942	1	7	40
WC942	DRA	GL	942	1	7	40
WCC2424	DRA	DR	1224	1	10	22
WCC2424	DRA	GL	1224	1	10	22
WCC2424	DRA	MD	1224	1	10	22
WCC2430	DRA	DR	1230	1	10	28
WCC2430	DRA	GL	1230	1	10	28
WCC2430	DRA	MD	1230	1	10	28
WCC2436	DRA	DR	1236	1	10	34
WCC2436	DRA	GL	1236	1	10	34
WCC2436	DRA	MD	1236	1	10	34
WCC2442	DRA	DR	1242	1	10	40
WCC2442	DRA	GL	1242	1	10	40
WCC2442	DRA	MD	1242	1	10	40
WCC3024	DRA	DR	1824	1	16	22
WCC3024	DRA	GL	1824	1	16	22
WCC3024	DRA	MD	1824	1	16	22
WCC3030	DRA	DR	1830	1	16	28
WCC3030	DRA	GL	1830	1	16	28
WCC3030	DRA	MD	1830	1	16	28
WCC3036	DRA	DR	1836	1	16	34
WCC3036	DRA	GL	1836	1	16	34
WCC3036	DRA	MD	1836	1	16	34
WCC3042	DRA	DR	1842	1	16	40
WCC3042	DRA	GL	1842	1	16	40
WCC3042	DRA	MD	1842	1	16	40

SUPPLEMENTAL PARTS – SOL

SKU	MAP	TYPE	PART ID	QTY	WIDTH	HEIGHT
WCC3624	DRA	DR	2424	1	22	22
WCC3624	DRA	GL	2424	1	22	22
WCC3624	DRA	MD	2424	1	22	22
WCC3630	DRA	DR	2430	1	22	28
WCC3630	DRA	GL	2430	1	22	28
WCC3630	DRA	MD	2430	1	22	28
WCC3636	DRA	DR	2436	1	22	34
WCC3636	DRA	GL	2436	1	22	34
WCC3636	DRA	MD	2436	1	22	34
WCC3642	DRA	DR	2442	1	22	40
WCC3642	DRA	GL	2442	1	22	40
WCC3642	DRA	MD	2442	1	22	40
WCC4230	DRA	DR	1530	2	13	28
WCC4230	DRA	GL	1530	2	13	28
WCC4230	DRA	MD	1530	2	13	28
WCC4236	DRA	DR	1536	2	13	34
WCC4236	DRA	GL	1536	2	13	34
WCC4236	DRA	MD	1536	2	13	34
WCC4242	DRA	DR	1542	2	13	40
WCC4242	DRA	GL	1542	2	13	40
WCC4242	DRA	MD	1542	2	13	40
WCC4830	DRA	DR	1830	2	16	28
WCC4830	DRA	GL	1830	2	16	28
WCC4830	DRA	MD	1830	2	16	28
WCC4836	DRA	DR	1836	2	16	34
WCC4836	DRA	GL	1836	2	16	34
WCC4836	DRA	MD	1836	2	16	34
WCC4842	DRA	DR	1842	2	16	40
WCC4842	DRA	GL	1842	2	16	40
WCC4842	DRA	MD	1842	2	16	40
WCMW2730	DRA	DR	2712	2	11 1/2	10
WCMW2730	DRA	GL	2712	2	11 1/2	10
WCMW2730	DRA	MD	2712	2	11 1/2	10
WCMW2730BP	DRA	DR	2712BP	2	12 7/16	10
WCMW2730BP	DRA	GL	2712BP	2	12 7/16	10
WCMW2730BP	DRA	MD	2712BP	2	12 7/16	10
WCMW2736	DRA	DR	2718	2	11 1/2	16
WCMW2736	DRA	GL	2718	2	11 1/2	16
WCMW2736	DRA	MD	2718	2	11 1/2	16
WCMW2736BP	DRA	DR	2718BP	2	12 7/16	16
WCMW2736BP	DRA	GL	2718BP	2	12 7/16	16
WCMW2736BP	DRA	MD	2718BP	2	12 7/16	16
WCMW2742	DRA	DR	2724	2	11 1/2	22
WCMW2742	DRA	GL	2724	2	11 1/2	22
WCMW2742	DRA	MD	2724	2	11 1/2	22
WCMW2742BP	DRA	DR	2724BP	2	12 7/16	22
WCMW2742BP	DRA	GL	2724BP	2	12 7/16	22
WCMW2742BP	DRA	MD	2724BP	2	12 7/16	22
WCMW3030	DRA	DR	1512	2	13	10
WCMW3030	DRA	GL	1512	2	13	10
WCMW3030	DRA	MD	1512	2	13	10
WCMW3030BP	DRA	DR	3012BP	2	13 15/16	10
WCMW3030BP	DRA	GL	3012BP	2	13 15/16	10
WCMW3030BP	DRA	MD	3012BP	2	13 15/16	10
WCMW3036	DRA	DR	1518	2	13	16
WCMW3036	DRA	GL	1518	2	13	16
WCMW3036	DRA	MD	1518	2	13	16

SUPPLEMENTAL PARTS – SOL

SKU	MAP	TYPE	PART ID	QTY	WIDTH	HEIGHT
WCMW3036BP	DRA	DR	3018BP	2	13 15/16	16
WCMW3036BP	DRA	GL	3018BP	2	13 15/16	16
WCMW3036BP	DRA	MD	3018BP	2	13 15/16	16
WCMW3042	DRA	DR	1524	2	13	22
WCMW3042	DRA	GL	1524	2	13	22
WCMW3042	DRA	MD	1524	2	13	22
WCMW3042BP	DRA	DR	3024BP	2	13 15/16	22
WCMW3042BP	DRA	GL	3024BP	2	13 15/16	22
WCMW3042BP	DRA	MD	3024BP	2	13 15/16	22
WEA1224	DRA	DR	924	2	7	22
WEA1224	DRA	GL	924	2	7	22
WEA1230	DRA	DR	930	2	7	28
WEA1230	DRA	GL	930	2	7	28
WEA1236	DRA	DR	936	2	7	34
WEA1236	DRA	GL	936	2	7	34
WEA1242	DRA	DR	942	2	7	40
WEA1242	DRA	GL	942	2	7	40
WEC1224	DRA	DR	WEC24	1	13 5/8	22
WEC1224	DRA	GL	WEC24	1	13 5/8	22
WEC1224	DRA	MD	WEC24	1	13 5/8	22
WEC1230	DRA	DR	WEC30	1	13 5/8	28
WEC1230	DRA	GL	WEC30	1	13 5/8	28
WEC1230	DRA	MD	WEC30	1	13 5/8	28
WEC1236	DRA	DR	WEC36	1	13 5/8	34
WEC1236	DRA	GL	WEC36	1	13 5/8	34
WEC1236	DRA	MD	WEC36	1	13 5/8	34
WEC1242	DRA	DR	WEC42	1	13 5/8	40
WEC1242	DRA	GL	WEC42	1	13 5/8	40
WEC1242	DRA	MD	WEC42	1	13 5/8	40

SUPPLEMENTAL PARTS – FOL

SKU	MAP	TYPE	PART ID	QTY	WIDTH	HEIGHT
#45 SAMPLE	DRA	DR	1218	1	11 5/8	17 5/8
#45 SAMPLE	DFA	DF	PB12	1	11 5/8	5 13/16
BEC24	DRA	DR	BEC	2	17 3/8	29 5/8
BFH12	DRA	DR	1230	1	11 5/8	29 5/8
BFH15	DRA	DR	1530	1	14 5/8	29 5/8
BFH18	DRA	DR	1830	1	17 5/8	29 5/8
BFH21	DRA	DR	2130	1	20 5/8	29 5/8
BFH24	DRA	DR	2430	1	23 5/8	29 5/8
BFH24BP	DRA	DR	2430BP	2	11 3/4	29 5/8
BFH27	DRA	DR	2730	2	13 1/8	29 5/8
BFH27BP	DRA	DR	2730BP	2	13 1/4	29 5/8
BFH30	DRA	DR	1530	2	14 5/8	29 5/8
BFH30BP	DRA	DR	3030BP	2	14 3/4	29 5/8
BFH33	DRA	DR	3330	2	16 1/8	29 5/8
BFH33BP	DRA	DR	3330BP	2	16 1/4	29 5/8
BFH36	DRA	DR	1830	2	17 5/8	29 5/8
BFH36BP	DRA	DR	3630BP	2	17 3/4	29 5/8
BFH39	DRA	DR	3930	2	19 1/8	29 5/8
BFH42	DRA	DR	2130	2	20 5/8	29 5/8
BFH45	DRA	DR	4530	2	22 1/8	29 5/8
BFH48	DRA	DR	2430	2	23 5/8	29 5/8
BFH9	DRA	DR	930	1	8 5/8	29 5/8
BSB24	DRA	DR	2424	1	23 5/8	23 5/8
BSB24	DFA	DF	PB24	1	23 5/8	5 13/16
BSB24BP	DRA	DR	2424BP	2	11 3/4	23 5/8
BSB24BP	DFA	DF	PB24	1	23 5/8	5 13/16
BSB27	DRA	DR	2724	2	13 1/8	23 5/8
BSB27	DFA	DF	PB27	2	13 1/8	5 13/16
BSB27BP	DRA	DR	2724BP	2	13 1/4	23 5/8
BSB27BP	DFA	DF	PB27BP	1	26 5/8	5 13/16
BSB30	DRA	DR	1524	2	14 5/8	23 5/8
BSB30	DFA	DF	PB15	2	14 5/8	5 13/16
BSB30BP	DRA	DR	3024BP	2	14 3/4	23 5/8
BSB30BP	DFA	DF	PB30BP	1	29 5/8	5 13/16
BSB33	DRA	DR	3324	2	16 1/8	23 5/8
BSB33	DFA	DF	PB33	2	16 1/8	5 13/16
BSB33BP	DRA	DR	3324BP	2	16 1/4	23 5/8
BSB33BP	DFA	DF	PB33BP	1	32 5/8	5 13/16
BSB36	DRA	DR	1824	2	17 5/8	23 5/8
BSB36	DFA	DF	PB18	2	17 5/8	5 13/16
BSB36BP	DRA	DR	3624BP	2	17 3/4	23 5/8
BSB36BP	DFA	DF	PB36BP	1	35 5/8	5 13/16
BSB39	DRA	DR	3924	2	19 1/8	23 5/8
BSB39	DFA	DF	PB39	2	19 1/8	5 13/16
BSB42	DRA	DR	2124	2	20 5/8	23 5/8
BSB42	DFA	DF	PB21	2	20 5/8	5 13/16
BSB45	DRA	DR	4524	2	22 1/8	23 5/8
BSB45	DFA	DF	PB45	2	22 1/8	5 13/16
BSB48	DRA	DR	2424	2	23 5/8	23 5/8
BSB48	DFA	DF	PB24	2	23 5/8	5 13/16
BSF12	DRA	DR	1224	1	11 5/8	23 5/8
BSF12	DFA	DF	PB12	1	11 5/8	5 13/16
BSF15	DRA	DR	1524	1	14 5/8	23 5/8
BSF15	DFA	DF	PB15	1	14 5/8	5 13/16
BSF18	DRA	DR	1824	1	17 5/8	23 5/8
BSF18	DFA	DF	PB18	1	17 5/8	5 13/16
BSF21	DRA	DR	2124	1	20 5/8	23 5/8
BSF21	DFA	DF	PB21	1	20 5/8	5 13/16

SUPPLEMENTAL PARTS – FOL

SKU	MAP	TYPE	PART ID	QTY	WIDTH	HEIGHT
BSF24	DRA	DR	2424	1	23 5/8	23 5/8
BSF24	DFA	DF	PB24	1	23 5/8	5 13/16
BSF27	DRA	DR	2724	2	13 1/8	23 5/8
BSF27	DFA	DF	PB27	2	13 1/8	5 13/16
BSF30	DRA	DR	1524	2	14 5/8	23 5/8
BSF30	DFA	DF	PB15	2	14 5/8	5 13/16
BSF33	DRA	DR	3324	2	16 1/8	23 5/8
BSF33	DFA	DF	PB33	2	16 1/8	5 13/16
BSF36	DRA	DR	1824	2	17 5/8	23 5/8
BSF36	DFA	DF	PB18	2	17 5/8	5 13/16
BSF39	DRA	DR	3924	2	19 1/8	23 5/8
BSF39	DFA	DF	PB39	2	19 1/8	5 13/16
BSF42	DRA	DR	2124	2	20 5/8	23 5/8
BSF42	DFA	DF	PB21	2	20 5/8	5 13/16
BSF45	DRA	DR	4524	2	22 1/8	23 5/8
BSF45	DFA	DF	PB45	2	22 1/8	5 13/16
BSF48	DRA	DR	2424	2	23 5/8	23 5/8
BSF48	DFA	DF	PB24	2	23 5/8	5 13/16
BSF9	DRA	DR	924	1	8 5/8	23 5/8
BSF9	DFA	DF	PB9	1	8 5/8	5 13/16
BTC12LH	DRA	DR	WEC30	1	15 1/4	29 5/8
BTC12RH	DRA	DR	WEC30	1	15 1/4	29 5/8
CSF165	DRA	DR	1524	1	14 5/8	23 5/8
CSF165	DFA	DF	PB15	1	14 5/8	5 13/16
CSF255	DRA	DR	2424	1	23 5/8	23 5/8
CSF255	DFA	DF	PB24	1	23 5/8	5 13/16
CWC2424	DRA	DR	CW24	1	15 1/8	23 5/8
CWC2424	DRA	GL	CW24	1	15 1/8	23 5/8
CWC2424	DRA	MD	CW24	1	15 1/8	23 5/8
CWC2430	DRA	DR	CW30	1	15 1/8	29 5/8
CWC2430	DRA	GL	CW30	1	15 1/8	29 5/8
CWC2430	DRA	MD	CW30	1	15 1/8	29 5/8
CWC2436	DRA	DR	CW36	1	15 1/8	35 5/8
CWC2436	DRA	GL	CW36	1	15 1/8	35 5/8
CWC2436	DRA	MD	CW36	1	15 1/8	35 5/8
CWC2442	DRA	DR	CW42	1	15 1/8	41 5/8
CWC2442	DRA	GL	CW42	1	15 1/8	41 5/8
CWC2442	DRA	MD	CW42	1	15 1/8	41 5/8
CWC2724	DRA	DR	CW24	1	15 1/8	23 5/8
CWC2724	DRA	GL	CW24	1	15 1/8	23 5/8
CWC2724	DRA	MD	CW24	1	15 1/8	23 5/8
CWC2730	DRA	DR	CW30	1	15 1/8	29 5/8
CWC2730	DRA	GL	CW30	1	15 1/8	29 5/8
CWC2730	DRA	MD	CW30	1	15 1/8	29 5/8
CWC2736	DRA	DR	CW36	1	15 1/8	35 5/8
CWC2736	DRA	GL	CW36	1	15 1/8	35 5/8
CWC2736	DRA	MD	CW36	1	15 1/8	35 5/8
CWC2742	DRA	DR	CW42	1	15 1/8	41 5/8
CWC2742	DRA	GL	CW42	1	15 1/8	41 5/8
CWC2742	DRA	MD	CW42	1	15 1/8	41 5/8
D2B18	DFA	DF	D2B18	2	17 5/8	14 23/32
D2B21	DFA	DF	D2B21	2	20 5/8	14 23/32
D2B24	DFA	DF	D2B24	2	23 5/8	14 23/32
D2B27	DFA	DF	D2B27	2	26 5/8	14 23/32
D2B30	DFA	DF	D2B30	2	29 5/8	14 23/32
D2B33	DFA	DF	D2B33	2	32 5/8	14 23/32
D2B36	DFA	DF	D2B36	2	35 5/8	14 23/32

SUPPLEMENTAL PARTS – FOL

SKU	MAP	TYPE	PART ID	QTY	WIDTH	HEIGHT
D3B12	DFA	DF	PB12	1	11 5/8	5 13/16
D3B12	DFB	DF	D3B12	2	11 5/8	11 23/32
D3B15	DFA	DF	PB15	1	14 5/8	5 13/16
D3B15	DFB	DF	D3B15	2	14 5/8	11 23/32
D3B18	DFA	DF	PB18	1	17 5/8	5 13/16
D3B18	DFB	DF	D3B18	2	17 5/8	11 23/32
D3B21	DFA	DF	PB21	1	20 5/8	5 13/16
D3B21	DFB	DF	D3B21	2	20 5/8	11 23/32
D3B24	DFA	DF	PB24	1	23 5/8	5 13/16
D3B24	DFB	DF	D3B24	2	23 5/8	11 23/32
D3B27	DFA	DF	PB27BP	1	26 5/8	5 13/16
D3B27	DFB	DF	D3B27	2	26 5/8	11 23/32
D3B30	DFA	DF	PB30BP	1	29 5/8	5 13/16
D3B30	DFB	DF	D3B30	2	29 5/8	11 23/32
D3B33	DFA	DF	PB33BP	1	32 5/8	5 13/16
D3B33	DFB	DF	D3B33	2	32 5/8	11 23/32
D3B36	DFA	DF	PB36BP	1	35 5/8	5 13/16
D3B36	DFB	DF	D3B36	2	35 5/8	11 23/32
DSB36	DRA	DR	CW24	1	15 1/8	23 5/8
DSB36	DFA	DF	DSB42	1	15 1/8	5 13/16
D4B12	DFA	DF	PB12	2	11 5/8	5 13/16
D4B12	DFB	DF	D4B12	2	11 5/8	8 23/32
D4B15	DFA	DF	PB15	2	14 5/8	5 13/16
D4B15	DFB	DF	D4B15	2	14 5/8	8 23/32
D4B18	DFA	DF	PB18	2	17 5/8	5 13/16
D4B18	DFB	DF	D4B18	2	17 5/8	8 23/32
D4B21	DFA	DF	PB21	2	20 5/8	5 13/16
D4B21	DFB	DF	D4B21	2	20 5/8	8 23/32
D4B24	DFA	DF	PB24	2	23 5/8	5 13/16
D4B24	DFB	DF	D4B24	2	23 5/8	8 23/32
D4B27	DFA	DF	PB27BP	2	26 5/8	5 13/16
D4B27	DFB	DF	D4B27	2	26 5/8	8 23/32
D4B30	DFA	DF	PB30BP	2	29 5/8	5 13/16
D4B30	DFB	DF	D4B30	2	29 5/8	8 23/32
D4B33	DFA	DF	PB33BP	2	32 5/8	5 13/16
D4B33	DFB	DF	D4B33	2	32 5/8	8 23/32
D4B36	DFA	DF	PB36BP	2	35 5/8	5 13/16
D4B36	DFB	DF	D4B36	2	35 5/8	8 23/32
DSB42BP	DRA	DR	2424BP	2	11 3/4	23 5/8
DSB42BP	DFA	DF	PB24	1	23 5/8	5 13/16
EZCB3333LH	DRA	DR	33	2	7 13/16	29 5/8
EZCB3333RH	DRA	DR	33	2	7 13/16	29 5/8
EZCB3636LH	DRA	DR	CB36	2	10 13/16	29 5/8
EZCB3636RH	DRA	DR	CB36	2	10 13/16	29 5/8
EZCW24LH	DRA	DR	CNR24	2	10 13/16	23 5/8
EZCW24RH	DRA	DR	CNR24	2	10 13/16	23 5/8
EZCW30LH	DRA	DR	CB36	2	10 13/16	29 5/8
EZCW30RH	DRA	DR	CB36	2	10 13/16	29 5/8
EZCW36LH	DRA	DR	CNR36	2	10 13/16	35 5/8
EZCW36RH	DRA	DR	CNR36	2	10 13/16	35 5/8
EZCW42LH	DRA	DR	CNR42	2	10 13/16	41 5/8
EZCW42RH	DRA	DR	CNR42	2	10 13/16	41 5/8
EZDCB3636	DRA	DR	CW30	1	15 1/8	29 5/8
FSB30	DRA	DR	1518	2	14 5/8	17 5/8
FSB30BP	DRA	DR	3018BP	2	14 3/4	17 5/8
FSB33	DRA	DR	3318	2	16 1/8	17 5/8
FSB33BP	DRA	DR	3318BP	2	16 1/4	17 5/8
FSB36	DRA	DR	1818	2	17 5/8	17 5/8

SUPPLEMENTAL PARTS – FOL

SKU	MAP	TYPE	PART ID	QTY	WIDTH	HEIGHT
FSB36BP	DRA	DR	3618BP	2	17 3/4	17 5/8
IB24	DRA	DR	2424	2	23 5/8	23 5/8
IB24	DFA	DF	PB24	2	23 5/8	5 13/16
IB24BP	DRA	DR	2424BP	4	11 3/4	23 5/8
IB24BP	DFA	DF	PB24	2	23 5/8	5 13/16
IB30	DRA	DR	1524	4	14 5/8	23 5/8
IB30	DFA	DF	PB15	4	14 5/8	5 13/16
IB30BP	DRA	DR	3024BP	4	14 3/4	23 5/8
IB30BP	DFA	DF	PB30BP	2	29 5/8	5 13/16
IB36	DRA	DR	1824	4	17 5/8	23 5/8
IB36	DFA	DF	PB18	4	17 5/8	5 13/16
IB36BP	DRA	DR	3624BP	4	17 3/4	23 5/8
IB36BP	DFA	DF	PB36BP	2	35 5/8	5 13/16
IB48	DRA	DR	2424	4	23 5/8	23 5/8
IB48	DFA	DF	PB24	4	23 5/8	5 13/16
IFH24	DRA	DR	2430	2	23 5/8	29 5/8
IFH24BP	DRA	DR	2430BP	4	11 3/4	29 5/8
IFH30	DRA	DR	1530	4	14 5/8	29 5/8
IFH30BP	DRA	DR	3030BP	4	14 3/4	29 5/8
IFH36	DRA	DR	1830	4	17 5/8	29 5/8
IFH36BP	DRA	DR	3630BP	4	17 3/4	29 5/8
IFH48	DRA	DR	2430	4	23 5/8	29 5/8
ISB24	DRA	DR	2424	2	23 5/8	23 5/8
ISB24	DFA	DF	PB24	2	23 5/8	5 13/16
ISB24BP	DRA	DR	2424BP	4	11 3/4	23 5/8
ISB24BP	DFA	DF	PB24	2	23 5/8	5 13/16
ISB30	DRA	DR	1524	4	14 5/8	23 5/8
ISB30	DFA	DF	PB15	4	14 5/8	5 13/16
ISB30BP	DRA	DR	3024BP	4	14 3/4	23 5/8
ISB30BP	DFA	DF	PB30BP	2	29 5/8	5 13/16
ISB36	DRA	DR	1824	4	17 5/8	23 5/8
ISB36	DFA	DF	PB18	4	17 5/8	5 13/16
ISB36BP	DRA	DR	3624BP	4	17 3/4	23 5/8
ISB36BP	DFA	DF	PB36BP	2	35 5/8	5 13/16
ISB48	DRA	DR	2424	4	23 5/8	23 5/8
ISB48	DFA	DF	PB24	4	23 5/8	5 13/16
IW3018	DRA	DR	1518	4	14 5/8	17 5/8
IW3018	DRA	GL	1518	4	14 5/8	17 5/8
IW3018	DRA	MD	1518	4	14 5/8	17 5/8
IW3018BP	DRA	DR	3018BP	4	14 3/4	17 5/8
IW3018BP	DRA	GL	3018BP	4	14 3/4	17 5/8
IW3018BP	DRA	MD	3018BP	4	14 3/4	17 5/8
IW3030	DRA	DR	1530	4	14 5/8	29 5/8
IW3030	DRA	GL	1530	4	14 5/8	29 5/8
IW3030	DRA	MD	1530	4	14 5/8	29 5/8
IW3030BP	DRA	DR	3030BP	4	14 3/4	29 5/8
IW3030BP	DRA	GL	3030BP	4	14 3/4	29 5/8
IW3030BP	DRA	MD	3030BP	4	14 3/4	29 5/8
LSCB3333LH	DRA	DR	33	2	7 13/16	29 5/8
LSCB3333RH	DRA	DR	33	2	7 13/16	29 5/8
LSCB3636LH	DRA	DR	CB36	2	10 13/16	29 5/8
LSCB3636RH	DRA	DR	CB36	2	10 13/16	29 5/8
LSDCB3636	DRA	DR	CW30	1	15 1/8	29 5/8
MB12	DRA	DR	1218	1	11 5/8	17 5/8
MB12	DFA	DF	PB12	1	11 5/8	5 13/16
MWB TRM24	DFA	DF	DBP24	1	23 5/8	11 23/32
MWB TRM27	DFA	DF	DBP27	1	26 5/8	11 23/32
MWB TRM30	DFA	DF	DBP30	1	29 5/8	11 23/32

SUPPLEMENTAL PARTS – FOL

SKU	MAP	TYPE	PART ID	QTY	WIDTH	HEIGHT
MWB24	DFA	DF	DBP24	1	23 5/8	11 23/32
MWB27	DFA	DF	DBP27	1	26 5/8	11 23/32
MWB30	DFA	DF	DBP30	1	29 5/8	11 23/32
OC3084T	DRA	DR	1518	2	14 5/8	17 5/8
OC3084T	DFA	DF	DB27	3	26 5/8	8 23/32
OC3090T	DRA	DR	1524	2	14 5/8	23 5/8
OC3090T	DFA	DF	DB27	3	26 5/8	8 23/32
OC3096T	DRA	DR	1530	2	14 5/8	29 5/8
OC3096T	DFA	DF	DB27	3	26 5/8	8 23/32
OC3384T	DRA	DR	3318	2	16 1/8	17 5/8
OC3384T	DFA	DF	DB30	3	29 5/8	8 23/32
OC3390T	DRA	DR	3324	2	16 1/8	23 5/8
OC3390T	DFA	DF	DB30	3	29 5/8	8 23/32
OC3396T	DRA	DR	3330	2	16 1/8	29 5/8
OC3396T	DFA	DF	DB30	3	29 5/8	8 23/32
PB12	DRA	DR	1224	1	11 5/8	23 5/8
PB12	DFA	DF	PB12	1	11 5/8	5 13/16
PB15	DRA	DR	1524	1	14 5/8	23 5/8
PB15	DFA	DF	PB15	1	14 5/8	5 13/16
PB18	DRA	DR	1824	1	17 5/8	23 5/8
PB18	DFA	DF	PB18	1	17 5/8	5 13/16
PB21	DRA	DR	2124	1	20 5/8	23 5/8
PB21	DFA	DF	PB21	1	20 5/8	5 13/16
PB24	DRA	DR	2424	1	23 5/8	23 5/8
PB24	DFA	DF	PB24	1	23 5/8	5 13/16
PB24BP	DRA	DR	2424BP	2	11 3/4	23 5/8
PB24BP	DFA	DF	PB24	1	23 5/8	5 13/16
PB27	DRA	DR	2724	2	13 1/8	23 5/8
PB27	DFA	DF	PB27	2	13 1/8	5 13/16
PB27BP	DRA	DR	2724BP	2	13 1/4	23 5/8
PB27BP	DFA	DF	PB27BP	1	26 5/8	5 13/16
PB30	DRA	DR	1524	2	14 5/8	23 5/8
PB30	DFA	DF	PB15	2	14 5/8	5 13/16
PB30BP	DRA	DR	3024BP	2	14 3/4	23 5/8
PB30BP	DFA	DF	PB30BP	1	29 5/8	5 13/16
PB33	DRA	DR	3324	2	16 1/8	23 5/8
PB33	DFA	DF	PB33	2	16 1/8	5 13/16
PB33BP	DRA	DR	3324BP	2	16 1/4	23 5/8
PB33BP	DFA	DF	PB33BP	1	32 5/8	5 13/16
PB36	DRA	DR	1824	2	17 5/8	23 5/8
PB36	DFA	DF	PB18	2	17 5/8	5 13/16
PB36BP	DRA	DR	3624BP	2	17 3/4	23 5/8
PB36BP	DFA	DF	PB36BP	1	35 5/8	5 13/16
PB39	DRA	DR	3924	2	19 1/8	23 5/8
PB39	DFA	DF	PB39	2	19 1/8	5 13/16
PB42	DRA	DR	2124	2	20 5/8	23 5/8
PB42	DFA	DF	PB21	2	20 5/8	5 13/16
PB45	DRA	DR	4524	2	22 1/8	23 5/8
PB45	DFA	DF	PB45	2	22 1/8	5 13/16
PB48	DRA	DR	2424	2	23 5/8	23 5/8
PB48	DFA	DF	PB24	2	23 5/8	5 13/16
PB9	DRA	DR	924	1	8 5/8	23 5/8
PB9	DFA	DF	PB9	1	8 5/8	5 13/16
RPBC36	DRA	DR	1224	1	11 5/8	23 5/8
RPBC36	DFA	DF	PB12	1	11 5/8	5 13/16
RPBC39	DRA	DR	1224	1	11 5/8	23 5/8
RPBC39	DFA	DF	PB12	1	11 5/8	5 13/16

SUPPLEMENTAL PARTS – FOL

SKU	MAP	TYPE	PART ID	QTY	WIDTH	HEIGHT
RPBC42	DRA	DR	1524	1	14 5/8	23 5/8
RPBC42	DFA	DF	PB15	1	14 5/8	5 13/16
RPBC45	DRA	DR	1824	1	17 5/8	23 5/8
RPBC45	DFA	DF	PB18	1	17 5/8	5 13/16
RPBC48	DRA	DR	2124	1	20 5/8	23 5/8
RPBC48	DFA	DF	PB21	1	20 5/8	5 13/16
RW3012	DRA	DR	1512	2	14 5/8	11 5/8
RW3012	DRA	GL	1512	2	14 5/8	11 5/8
RW3012	DRA	MD	1512	2	14 5/8	11 5/8
RW3015	DRA	DR	1515	2	14 5/8	14 5/8
RW3015	DRA	GL	1515	2	14 5/8	14 5/8
RW3015	DRA	MD	1515	2	14 5/8	14 5/8
RW3018	DRA	DR	1518	2	14 5/8	17 5/8
RW3018	DRA	GL	1518	2	14 5/8	17 5/8
RW3018	DRA	MD	1518	2	14 5/8	17 5/8
RW3021	DRA	DR	1521	2	14 5/8	20 5/8
RW3021	DRA	GL	1521	2	14 5/8	20 5/8
RW3021	DRA	MD	1521	2	14 5/8	20 5/8
RW3024	DRA	DR	1524	2	14 5/8	23 5/8
RW3024	DRA	GL	1524	2	14 5/8	23 5/8
RW3024	DRA	MD	1524	2	14 5/8	23 5/8
RW3312	DRA	DR	3312	2	16 1/8	11 5/8
RW3312	DRA	GL	3312	2	16 1/8	11 5/8
RW3312	DRA	MD	3312	2	16 1/8	11 5/8
RW3315	DRA	DR	3315	2	16 1/8	14 5/8
RW3315	DRA	GL	3315	2	16 1/8	14 5/8
RW3315	DRA	MD	3315	2	16 1/8	14 5/8
RW3318	DRA	DR	3318	2	16 1/8	17 5/8
RW3318	DRA	GL	3318	2	16 1/8	17 5/8
RW3318	DRA	MD	3318	2	16 1/8	17 5/8
RW3321	DRA	DR	3321	2	16 1/8	20 5/8
RW3321	DRA	GL	3321	2	16 1/8	20 5/8
RW3321	DRA	MD	3321	2	16 1/8	20 5/8
RW3324	DRA	DR	3324	2	16 1/8	23 5/8
RW3324	DRA	GL	3324	2	16 1/8	23 5/8
RW3324	DRA	MD	3324	2	16 1/8	23 5/8
RW3612	DRA	DR	1812	2	17 5/8	11 5/8
RW3612	DRA	GL	1812	2	17 5/8	11 5/8
RW3612	DRA	MD	1812	2	17 5/8	11 5/8
RW3615	DRA	DR	1815	2	17 5/8	14 5/8
RW3615	DRA	GL	1815	2	17 5/8	14 5/8
RW3615	DRA	MD	1815	2	17 5/8	14 5/8
RW3618	DRA	DR	1818	2	17 5/8	17 5/8
RW3618	DRA	GL	1818	2	17 5/8	17 5/8
RW3618	DRA	MD	1818	2	17 5/8	17 5/8
RW3621	DRA	DR	1821	2	17 5/8	20 5/8
RW3621	DRA	GL	1821	2	17 5/8	20 5/8
RW3621	DRA	MD	1821	2	17 5/8	20 5/8
RW3624	DRA	DR	1824	2	17 5/8	23 5/8
RW3624	DRA	GL	1824	2	17 5/8	23 5/8
RW3624	DRA	MD	1824	2	17 5/8	23 5/8
RW3912	DRA	DR	3912	2	19 1/8	11 5/8
RW3912	DRA	GL	3912	2	19 1/8	11 5/8
RW3912	DRA	MD	3912	2	19 1/8	11 5/8
RW3915	DRA	DR	3915	2	19 1/8	14 5/8
RW3915	DRA	GL	3915	2	19 1/8	14 5/8
RW3915	DRA	MD	3915	2	19 1/8	14 5/8

SUPPLEMENTAL PARTS – FOL

SKU	MAP	TYPE	PART ID	QTY	WIDTH	HEIGHT
RW3918	DRA	DR	3918	2	19 1/8	17 5/8
RW3918	DRA	GL	3918	2	19 1/8	17 5/8
RW3918	DRA	MD	3918	2	19 1/8	17 5/8
RW3921	DRA	DR	3921	2	19 1/8	20 5/8
RW3921	DRA	GL	3921	2	19 1/8	20 5/8
RW3921	DRA	MD	3921	2	19 1/8	20 5/8
RW3924	DRA	DR	3924	2	19 1/8	23 5/8
RW3924	DRA	GL	3924	2	19 1/8	23 5/8
RW3924	DRA	MD	3924	2	19 1/8	23 5/8
RW4212	DRA	DR	2112	2	20 5/8	11 5/8
RW4212	DRA	GL	2112	2	20 5/8	11 5/8
RW4212	DRA	MD	2112	2	20 5/8	11 5/8
RW4215	DRA	DR	2115	2	20 5/8	14 5/8
RW4215	DRA	GL	2115	2	20 5/8	14 5/8
RW4215	DRA	MD	2115	2	20 5/8	14 5/8
RW4218	DRA	DR	2118	2	20 5/8	17 5/8
RW4218	DRA	GL	2118	2	20 5/8	17 5/8
RW4218	DRA	MD	2118	2	20 5/8	17 5/8
RW4221	DRA	DR	2121	2	20 5/8	20 5/8
RW4221	DRA	GL	2121	2	20 5/8	20 5/8
RW4221	DRA	MD	2121	2	20 5/8	20 5/8
RW4224	DRA	DR	2124	2	20 5/8	23 5/8
RW4224	DRA	GL	2124	2	20 5/8	23 5/8
RW4224	DRA	MD	2124	2	20 5/8	23 5/8
RW4512BP	DRA	DR	4512BP	4	11	11 5/8
RW4512BP	DRA	GL	4512BP	4	11	11 5/8
RW4512BP	DRA	MD	4512BP	4	11	11 5/8
RW4515BP	DRA	DR	4515BP	4	11	14 5/8
RW4515BP	DRA	GL	4515BP	4	11	14 5/8
RW4515BP	DRA	MD	4515BP	4	11	14 5/8
RW4518BP	DRA	DR	4518BP	4	11	17 5/8
RW4518BP	DRA	GL	4518BP	4	11	17 5/8
RW4518BP	DRA	MD	4518BP	4	11	17 5/8
RW4521BP	DRA	DR	4521BP	4	11	20 5/8
RW4521BP	DRA	GL	4521BP	4	11	20 5/8
RW4521BP	DRA	MD	4521BP	4	11	20 5/8
RW4524BP	DRA	DR	4524BP	4	11	23 5/8
RW4524BP	DRA	GL	4524BP	4	11	23 5/8
RW4524BP	DRA	MD	4524BP	4	11	23 5/8
RW4812BP	DRA	DR	2412BP	4	11 3/4	11 5/8
RW4812BP	DRA	GL	2412BP	4	11 3/4	11 5/8
RW4812BP	DRA	MD	2412BP	4	11 3/4	11 5/8
RW4815BP	DRA	DR	2415BP	4	11 3/4	14 5/8
RW4815BP	DRA	GL	2415BP	4	11 3/4	14 5/8
RW4815BP	DRA	MD	2415BP	4	11 3/4	14 5/8
RW4818BP	DRA	DR	2418BP	4	11 3/4	17 5/8
RW4818BP	DRA	GL	2418BP	4	11 3/4	17 5/8
RW4818BP	DRA	MD	2418BP	4	11 3/4	17 5/8
RW4821BP	DRA	DR	2421BP	4	11 3/4	20 5/8
RW4821BP	DRA	GL	2421BP	4	11 3/4	20 5/8
RW4821BP	DRA	MD	2421BP	4	11 3/4	20 5/8
RW4824BP	DRA	DR	2424BP	4	11 3/4	23 5/8
RW4824BP	DRA	GL	2424BP	4	11 3/4	23 5/8
RW4824BP	DRA	MD	2424BP	4	11 3/4	23 5/8
SSCB3636LH	DRA	DR	CB36	2	10 13/16	29 5/8
SSCB3636RH	DRA	DR	CB36	2	10 13/16	29 5/8
SSDCB3636	DRA	DR	CW30	1	15 1/8	29 5/8

SUPPLEMENTAL PARTS – FOL

SKU	MAP	TYPE	PART ID	QTY	WIDTH	HEIGHT
UC158412	DRA	DR	1530	1	14 5/8	29 5/8
UC158412	DRB	DR	15UC	1	14 5/8	49 1/8
UC158424	DRA	DR	1530	1	14 5/8	29 5/8
UC158424	DRB	DR	15UC	1	14 5/8	49 1/8
UC159012	DRA	DR	1536	1	14 5/8	35 5/8
UC159012	DRB	DR	15UC	1	14 5/8	49 1/8
UC159024	DRA	DR	1536	1	14 5/8	35 5/8
UC159024	DRB	DR	15UC	1	14 5/8	49 1/8
UC159612	DRA	DR	1542	1	14 5/8	41 5/8
UC159612	DRB	DR	15UC	1	14 5/8	49 1/8
UC159624	DRA	DR	1542	1	14 5/8	41 5/8
UC159624	DRB	DR	15UC	1	14 5/8	49 1/8
UC188412	DRA	DR	1830	1	17 5/8	29 5/8
UC188412	DRB	DR	18UC	1	17 5/8	49 1/8
UC188424	DRA	DR	1830	1	17 5/8	29 5/8
UC188424	DRB	DR	18UC	1	17 5/8	49 1/8
UC189012	DRA	DR	1836	1	17 5/8	35 5/8
UC189012	DRB	DR	18UC	1	17 5/8	49 1/8
UC189024	DRA	DR	1836	1	17 5/8	35 5/8
UC189024	DRB	DR	18UC	1	17 5/8	49 1/8
UC189612	DRA	DR	1842	1	17 5/8	41 5/8
UC189612	DRB	DR	18UC	1	17 5/8	49 1/8
UC189624	DRA	DR	1842	1	17 5/8	41 5/8
UC189624	DRB	DR	18UC	1	17 5/8	49 1/8
UC248412	DRA	DR	2430BP	2	11 3/4	29 5/8
UC248412	DRB	DR	24UC	2	11 3/4	49 1/8
UC248424	DRA	DR	2430BP	2	11 3/4	29 5/8
UC248424	DRB	DR	24UC	2	11 3/4	49 1/8
UC249012	DRA	DR	2436BP	2	11 3/4	35 5/8
UC249012	DRB	DR	24UC	2	11 3/4	49 1/8
UC249024	DRA	DR	2436BP	2	11 3/4	35 5/8
UC249024	DRB	DR	24UC	2	11 3/4	49 1/8
UC249612	DRA	DR	2442BP	2	11 3/4	41 5/8
UC249612	DRB	DR	24UC	2	11 3/4	49 1/8
UC249624	DRA	DR	2442BP	2	11 3/4	41 5/8
UC249624	DRB	DR	24UC	2	11 3/4	49 1/8
UC308412	DRA	DR	3030BP	2	14 3/4	29 5/8
UC308412	DRB	DR	30UC	2	14 3/4	49 1/8
UC308424	DRA	DR	3030BP	2	14 3/4	29 5/8
UC308424	DRB	DR	30UC	2	14 3/4	49 1/8
UC309012	DRA	DR	3036BP	2	14 3/4	35 5/8
UC309012	DRB	DR	30UC	2	14 3/4	49 1/8
UC309024	DRA	DR	3036BP	2	14 3/4	35 5/8
UC309024	DRB	DR	30UC	2	14 3/4	49 1/8
UC309612	DRA	DR	3042BP	2	14 3/4	41 5/8
UC309612	DRB	DR	30UC	2	14 3/4	49 1/8
UC309624	DRA	DR	3042BP	2	14 3/4	41 5/8
UC309624	DRB	DR	30UC	2	14 3/4	49 1/8
UC368412	DRA	DR	3630BP	2	17 3/4	29 5/8
UC368412	DRB	DR	36UC	2	17 3/4	49 1/8
UC368424	DRA	DR	3630BP	2	17 3/4	29 5/8
UC368424	DRB	DR	36UC	2	17 3/4	49 1/8
UC369012	DRA	DR	3636BP	2	17 3/4	35 5/8
UC369012	DRB	DR	36UC	2	17 3/4	49 1/8
UC369024	DRA	DR	3636BP	2	17 3/4	35 5/8
UC369024	DRB	DR	36UC	2	17 3/4	49 1/8
UC369612	DRA	DR	3642BP	2	17 3/4	41 5/8
UC369612	DRB	DR	36UC	2	17 3/4	49 1/8

SUPPLEMENTAL PARTS – FOL

SKU	MAP	TYPE	PART ID	QTY	WIDTH	HEIGHT
UC369624	DRA	DR	3642BP	2	17 3/4	41 5/8
UC369624	DRB	DR	36UC	2	17 3/4	49 1/8
V3D12	DFA	DF	PB12	1	11 5/8	5 13/16
V3D12	DFB	DF	V3D12	2	11 5/8	10 7/32
V3D15	DFA	DF	PB15	1	14 5/8	5 13/16
V3D15	DFB	DF	V3D15	2	14 5/8	10 7/32
V3D18	DFA	DF	PB18	1	17 5/8	5 13/16
V3D18	DFB	DF	V3D18	2	17 5/8	10 7/32
V3D21	DFA	DF	PB21	1	20 5/8	5 13/16
V3D21	DFB	DF	V3D21	2	20 5/8	10 7/32
V3D24	DFA	DF	PB24	1	23 5/8	5 13/16
V3D24	DFB	DF	V3D24	2	23 5/8	10 7/32
V3D12BH	DFA	DF	PB12	1	11 5/8	5 13/16
V3D12BH	DFB	DF	DBP12	2	11 5/8	11 23/32
V3D15BH	DFA	DF	PB15	1	14 5/8	5 13/16
V3D15BH	DFB	DF	DBP15	2	14 5/8	11 23/32
V3D18BH	DFA	DF	PB18	1	17 5/8	5 13/16
V3D18BH	DFB	DF	DBP18	2	17 5/8	11 23/32
V3D21BH	DFA	DF	PB21	1	20 5/8	5 13/16
V3D21BH	DFB	DF	DBP21	2	20 5/8	11 23/32
V3D24BH	DFA	DF	PB24	1	23 5/8	5 13/16
V3D24BH	DFB	DF	DBP24	2	23 5/8	11 23/32
V4D12BH	DFA	DF	PB12	2	11 5/8	5 13/16
V4D12BH	DFB	DF	D4B12	2	11 5/8	8 23/32
V4D15BH	DFA	DF	PB15	2	14 5/8	5 13/16
V4D15BH	DFB	DF	D4B15	2	14 5/8	8 23/32
V4D18BH	DFA	DF	PB18	2	17 5/8	5 13/16
V4D18BH	DFB	DF	D4B18	2	17 5/8	8 23/32
V4D21BH	DFA	DF	PB21	2	20 5/8	5 13/16
V4D21BH	DFB	DF	D4B21	2	20 5/8	8 23/32
V4D24BH	DFA	DF	PB24	2	23 5/8	5 13/16
V4D24BH	DFB	DF	D4B24	2	23 5/8	8 23/32
VB12	DRA	DR	1221	1	11 5/8	20 5/8
VB12	DFA	DF	PB12	1	11 5/8	5 13/16
VB12BH	DRA	DR	1224	1	11 5/8	23 5/8
VB12BH	DFA	DF	PB12	1	11 5/8	5 13/16
VB15	DRA	DR	1521	1	14 5/8	20 5/8
VB15	DFA	DF	PB15	1	14 5/8	5 13/16
VB15BH	DRA	DR	1524	1	14 5/8	23 5/8
VB15BH	DFA	DF	PB15	1	14 5/8	5 13/16
VB18	DRA	DR	1821	1	17 5/8	20 5/8
VB18	DFA	DF	PB18	1	17 5/8	5 13/16
VB18BH	DRA	DR	1824	1	17 5/8	23 5/8
VB18BH	DFA	DF	PB18	1	17 5/8	5 13/16
VB21	DRA	DR	2121	1	20 5/8	20 5/8
VB21	DFA	DF	PB21	1	20 5/8	5 13/16
VB21BH	DRA	DR	2124	1	20 5/8	23 5/8
VB21BH	DFA	DF	PB21	1	20 5/8	5 13/16
VB24	DRA	DR	2421	1	23 5/8	20 5/8
VB24	DFA	DF	PB24	1	23 5/8	5 13/16
VB24BH	DRA	DR	2424	1	23 5/8	23 5/8
VB24BH	DFA	DF	PB24	1	23 5/8	5 13/16
VB24BHBP	DRA	DR	2424BP	2	11 3/4	23 5/8
VB24BHBP	DFA	DF	PB24	1	23 5/8	5 13/16
VB24BP	DRA	DR	2421BP	2	11 3/4	20 5/8
VB24BP	DFA	DF	PB24	1	23 5/8	5 13/16
VB27	DRA	DR	2721	2	13 1/8	20 5/8
VB27	DFA	DF	PB27	2	13 1/8	5 13/16

SUPPLEMENTAL PARTS – FOL

SKU	MAP	TYPE	PART ID	QTY	WIDTH	HEIGHT
VB27BH	DRA	DR	2724	2	13 1/8	23 5/8
VB27BH	DFA	DF	PB27	2	13 1/8	5 13/16
VB27BHBP	DRA	DR	2724BP	2	13 1/4	23 5/8
VB27BHBP	DFA	DF	PB27BP	1	26 5/8	5 13/16
VB27BP	DRA	DR	2721BP	2	13 1/4	20 5/8
VB27BP	DFA	DF	PB27BP	1	26 5/8	5 13/16
VB30	DRA	DR	1521	2	14 5/8	20 5/8
VB30	DFA	DF	PB15	2	14 5/8	5 13/16
VB30BH	DRA	DR	1524	2	14 5/8	23 5/8
VB30BH	DFA	DF	PB15	2	14 5/8	5 13/16
VB30BHBP	DRA	DR	3024BP	2	14 3/4	23 5/8
VB30BHBP	DFA	DF	PB30BP	1	29 5/8	5 13/16
VB30BP	DRA	DR	3021BP	2	14 3/4	20 5/8
VB30BP	DFA	DF	PB30BP	1	29 5/8	5 13/16
VB33	DRA	DR	3321	2	16 1/8	20 5/8
VB33	DFA	DF	PB33	2	16 1/8	5 13/16
VB33BH	DRA	DR	3324	2	16 1/8	23 5/8
VB33BH	DFA	DF	PB33	2	16 1/8	5 13/16
VB33BHBP	DRA	DR	3324BP	2	16 1/4	23 5/8
VB33BHBP	DFA	DF	PB33BP	1	32 5/8	5 13/16
VB33BP	DRA	DR	3321BP	2	16 1/4	20 5/8
VB33BP	DFA	DF	PB33BP	1	32 5/8	5 13/16
VB36	DRA	DR	1821	2	17 5/8	20 5/8
VB36	DFA	DF	PB18	2	17 5/8	5 13/16
VB36BH	DRA	DR	1824	2	17 5/8	23 5/8
VB36BH	DFA	DF	PB18	2	17 5/8	5 13/16
VB36BHBP	DRA	DR	3624BP	2	17 3/4	23 5/8
VB36BHBP	DFA	DF	PB36BP	1	35 5/8	5 13/16
VB36BP	DRA	DR	3621BP	2	17 3/4	20 5/8
VB36BP	DFA	DF	PB36BP	1	35 5/8	5 13/16
VB39	DRA	DR	3921	2	19 1/8	20 5/8
VB39	DFA	DF	PB39	2	19 1/8	5 13/16
VB39BH	DRA	DR	3924	2	19 1/8	23 5/8
VB39BH	DFA	DF	PB39	2	19 1/8	5 13/16
VB42	DRA	DR	2121	2	20 5/8	20 5/8
VB42	DFA	DF	PB21	2	20 5/8	5 13/16
VB42BH	DRA	DR	2124	2	20 5/8	23 5/8
VB42BH	DFA	DF	PB21	2	20 5/8	5 13/16
VB45BHBP	DRA	DR	4524BP	4	11	23 5/8
VB45BHBP	DFA	DF	PB45	2	22 1/8	5 13/16
VB45BP	DRA	DR	4521BP	4	11	20 5/8
VB45BP	DFA	DF	PB45	2	22 1/8	5 13/16
VB48BHBP	DRA	DR	2424BP	4	11 3/4	23 5/8
VB48BHBP	DFA	DF	PB24	2	23 5/8	5 13/16
VB48BP	DRA	DR	2421BP	4	11 3/4	20 5/8
VB48BP	DFA	DF	PB24	2	23 5/8	5 13/16
VB9	DRA	DR	921	1	8 5/8	20 5/8
VB9	DFA	DF	PB9	1	8 5/8	5 13/16
VB9BH	DRA	DR	924	1	8 5/8	23 5/8
VB9BH	DFA	DF	PB9	1	8 5/8	5 13/16
VDL33	DRA	DR	3321	2	16 1/8	20 5/8
VDL33	DFA	DF	PB9	2	8 5/8	5 13/16
VDL33	DFB	DF	PB15	1	14 5/8	5 13/16
VDL33BH	DRA	DR	3324	2	16 1/8	23 5/8
VDL33BH	DFA	DF	PB9	2	8 5/8	5 13/16
VDL33BH	DFB	DF	PB15	1	14 5/8	5 13/16

SUPPLEMENTAL PARTS – FOL

SKU	MAP	TYPE	PART ID	QTY	WIDTH	HEIGHT
VDL36	DRA	DR	1821	2	17 5/8	20 5/8
VDL36	DFA	DF	PB9	2	8 5/8	5 13/16
VDL36	DFB	DF	PB18	1	17 5/8	5 13/16
VDL36BH	DRA	DR	1824	2	17 5/8	23 5/8
VDL36BH	DFA	DF	PB9	2	8 5/8	5 13/16
VDL36BH	DFB	DF	PB18	1	17 5/8	5 13/16
VDL39	DRA	DR	3921	2	19 1/8	20 5/8
VDL39	DFA	DF	PB9	2	8 5/8	5 13/16
VDL39	DFB	DF	PB21	1	20 5/8	5 13/16
VDL39BH	DRA	DR	3924	2	19 1/8	23 5/8
VDL39BH	DFA	DF	PB9	2	8 5/8	5 13/16
VDL39BH	DFB	DF	PB21	1	20 5/8	5 13/16
VDL42	DRA	DR	2121	2	20 5/8	20 5/8
VDL42	DFA	DF	PB12	2	11 5/8	5 13/16
VDL42	DFB	DF	PB18	1	17 5/8	5 13/16
VDL42BH	DRA	DR	2124	2	20 5/8	23 5/8
VDL42BH	DFA	DF	PB12	2	11 5/8	5 13/16
VDL42BH	DFB	DF	PB18	1	17 5/8	5 13/16
VDL45	DRA	DR	4521	2	22 1/8	20 5/8
VDL45	DFA	DF	PB12	2	11 5/8	5 13/16
VDL45	DFB	DF	PB21	1	20 5/8	5 13/16
VDL45BH	DRA	DR	4524	2	22 1/8	23 5/8
VDL45BH	DFA	DF	PB12	2	11 5/8	5 13/16
VDL45BH	DFB	DF	PB21	1	20 5/8	5 13/16
VDL48	DRA	DR	2421	2	23 5/8	20 5/8
VDL48	DFA	DF	PB15	2	14 5/8	5 13/16
VDL48	DFB	DF	PB18	1	17 5/8	5 13/16
VDL48BH	DRA	DR	2424	2	23 5/8	23 5/8
VDL48BH	DFA	DF	PB15	2	14 5/8	5 13/16
VDL48BH	DFB	DF	PB18	1	17 5/8	5 13/16
VDL54BHBP	DRA	DR	2424BP	2	11 3/4	23 5/8
VDL54BHBP	DRB	DR	1524	2	14 5/8	23 5/8
VDL54BHBP	DFA	DF	PB15	2	14 5/8	5 13/16
VDL54BHBP	DFB	DF	PB24	1	23 5/8	5 13/16
VDL54BP	DRA	DR	2421BP	2	11 3/4	20 5/8
VDL54BP	DRB	DR	1521	2	14 5/8	20 5/8
VDL54BP	DFA	DF	PB15	2	14 5/8	5 13/16
VDL54BP	DFB	DF	PB24	1	23 5/8	5 13/16
VDL58	DRA	DR	2427BP	4	11 3/4	26 5/8
VDL58	DFA	DF	VDL58	1	9 5/8	5 13/16
VDL58	DFB	DF	VDL58BT	2	9 5/8	10 7/32
VDL58BH	DRA	DR	2424BP	4	11 3/4	23 5/8
VDL58BH	DFA	DF	PB24	2	23 5/8	5 13/16
VDL58BH	DFB	DF	VDL58	2	9 5/8	5 13/16
VDL58BH	DFC	DF	VDL58BH	2	9 5/8	8 23/32
VDL60BHBP	DRA	DR	2424BP	2	11 3/4	23 5/8
VDL60BHBP	DRB	DR	1824	2	17 5/8	23 5/8
VDL60BHBP	DFA	DF	PB18	2	17 5/8	5 13/16
VDL60BHBP	DFB	DF	PB24	1	23 5/8	5 13/16
VDL60BP	DRA	DR	2421BP	2	11 3/4	20 5/8
VDL60BP	DRB	DR	1821	2	17 5/8	20 5/8
VDL60BP	DFA	DF	PB18	2	17 5/8	5 13/16
VDL60BP	DFB	DF	PB24	1	23 5/8	5 13/16
VDL72	DRA	DR	1821	4	17 5/8	20 5/8
VDL72	DFA	DF	PB18	4	17 5/8	5 13/16
VDL72BH	DRA	DR	1824	4	17 5/8	23 5/8
VDL72BH	DFA	DF	PB18	4	17 5/8	5 13/16
VDU36	DFA	DF	PB24	1	23 5/8	5 13/16

SUPPLEMENTAL PARTS – FOL

SKU	MAP	TYPE	PART ID	QTY	WIDTH	HEIGHT
VFD18	DFA	DF	PB18	2	17 5/8	5 13/16
VFD18	DFB	DF	VFD18	1	17 5/8	14 5/8
VFD18BH	DFA	DF	D2B18	2	17 5/8	14 23/32
VFD21	DFA	DF	PB18	2	20 5/8	5 13/16
VFD21	DFB	DF	VFD21	1	20 5/8	14 23/32
VFD21BH	DFA	DF	D2B21	2	20 5/8	14 23/32
VFH12	DRA	DR	1227	1	11 5/8	26 5/8
VFH12BH	DRA	DR	1230	1	11 5/8	29 5/8
VFH15	DRA	DR	1527	1	14 5/8	26 5/8
VFH15BH	DRA	DR	1530	1	14 5/8	29 5/8
VFH18	DRA	DR	1827	1	17 5/8	26 5/8
VFH1816	DRA	DR	1827	1	17 5/8	26 5/8
VFH18BH	DRA	DR	1830	1	17 5/8	29 5/8
VFH21	DRA	DR	2127	1	20 5/8	26 5/8
VFH21BH	DRA	DR	2130	1	20 5/8	29 5/8
VFH2418	DRA	DR	2427BP	2	11 3/4	26 5/8
VFH24BHBP	DRA	DR	2430BP	2	11 3/4	29 5/8
VFH24BP	DRA	DR	2427BP	2	11 3/4	26 5/8
VFH27	DRA	DR	2727	2	13 1/8	26 5/8
VFH27BH	DRA	DR	2730	2	13 1/8	29 5/8
VFH27BHBP	DRA	DR	2730BP	2	13 1/4	29 5/8
VFH27BP	DRA	DR	2727BP	2	13 1/4	26 5/8
VFH30	DRA	DR	1527	2	14 5/8	26 5/8
VFH3018	DRA	DR	1527	2	14 5/8	26 5/8
VFH30BH	DRA	DR	1530	2	14 5/8	29 5/8
VFH30BHBP	DRA	DR	3030BP	2	14 3/4	29 5/8
VFH30BP	DRA	DR	3027BP	2	14 3/4	26 5/8
VFH33	DRA	DR	3327	2	16 1/8	26 5/8
VFH3318	DRA	DR	3327	2	16 1/8	26 5/8
VFH33BH	DRA	DR	3330	2	16 1/8	29 5/8
VFH33BHBP	DRA	DR	3330BP	2	16 1/4	29 5/8
VFH33BP	DRA	DR	3327BP	2	16 1/4	26 5/8
VFH36	DRA	DR	1827	2	17 5/8	26 5/8
VFH3618	DRA	DR	1827	2	17 5/8	26 5/8
VFH36BH	DRA	DR	1830	2	17 5/8	29 5/8
VFH36BHBP	DRA	DR	3630BP	2	17 3/4	29 5/8
VFH36BP	DRA	DR	3627BP	2	17 3/4	26 5/8
VFH39BHBP	DRA	DR	3930BP	2	19 1/4	29 5/8
VFH39BP	DRA	DR	3927BP	2	19 1/4	26 5/8
VFH42	DRA	DR	2127	2	20 5/8	26 5/8
VFH42BH	DRA	DR	2130	2	20 5/8	29 5/8
VFH42BHBP	DRA	DR	4230BP	2	20 3/4	29 5/8
VFH42BP	DRA	DR	4227BP	2	20 3/4	26 5/8
VFH45BHBP	DRA	DR	4530BP	4	11	29 5/8
VFH45BP	DRA	DR	4527BP	4	11	26 5/8
VFH48BHBP	DRA	DR	2430BP	4	11 3/4	29 5/8
VFH48BP	DRA	DR	2427BP	4	11 3/4	26 5/8
VFH54BHBP	DRA	DR	2730BP	4	13 1/4	29 5/8
VFH54BP	DRA	DR	2727BP	4	13 1/4	26 5/8
VFH60BHBP	DRA	DR	3030BP	4	14 3/4	29 5/8
VFH60BP	DRA	DR	3027BP	4	14 3/4	26 5/8
VFH72	DRA	DR	1827	4	17 5/8	26 5/8
VFH72BH	DRA	DR	1830	4	17 5/8	29 5/8
VFH9	DRA	DR	927	1	8 5/8	26 5/8
VFH9BH	DRA	DR	930	1	8 5/8	29 5/8
VLF24	DRA	DR	2427BP	2	11 3/4	26 5/8
VLF30	DRA	DR	1527	2	14 5/8	26 5/8
VLF36	DRA	DR	1827	2	17 5/8	26 5/8

SUPPLEMENTAL PARTS – FOL

SKU	MAP	TYPE	PART ID	QTY	WIDTH	HEIGHT
VS18	DRA	DR	1821	1	17 5/8	20 5/8
VS18	DFA	DF	PB18	1	17 5/8	5 13/16
VS18BH	DRA	DR	1824	1	17 5/8	23 5/8
VS18BH	DFA	DF	PB18	1	17 5/8	5 13/16
VS21	DRA	DR	2121	1	20 5/8	20 5/8
VS21	DFA	DF	PB21	1	20 5/8	5 13/16
VS21BH	DRA	DR	2124	1	20 5/8	23 5/8
VS21BH	DFA	DF	PB21	1	20 5/8	5 13/16
VS24	DRA	DR	2421	1	23 5/8	20 5/8
VS24	DFA	DF	PB24	1	23 5/8	5 13/16
VS24BH	DRA	DR	2424	1	23 5/8	23 5/8
VS24BH	DFA	DF	PB24	1	23 5/8	5 13/16
VS24BHBP	DRA	DR	2424BP	2	11 3/4	23 5/8
VS24BHBP	DFA	DF	PB24	1	23 5/8	5 13/16
VS24BP	DRA	DR	2421BP	2	11 3/4	20 5/8
VS24BP	DFA	DF	PB24	1	23 5/8	5 13/16
VS27	DRA	DR	2721	2	13 1/8	20 5/8
VS27	DFA	DF	PB27	2	13 1/8	5 13/16
VS27BH	DRA	DR	2724	2	13 1/8	23 5/8
VS27BH	DFA	DF	PB27	2	13 1/8	5 13/16
VS27BHBP	DRA	DR	2724BP	2	13 1/4	23 5/8
VS27BHBP	DFA	DF	PB27BP	1	26 5/8	5 13/16
VS27BP	DRA	DR	2721BP	2	13 1/4	20 5/8
VS27BP	DFA	DF	PB27BP	1	26 5/8	5 13/16
VS30	DRA	DR	1521	2	14 5/8	20 5/8
VS30	DFA	DF	PB15	2	14 5/8	5 13/16
VS30BH	DRA	DR	1524	2	14 5/8	23 5/8
VS30BH	DFA	DF	PB15	2	14 5/8	5 13/16
VS30BHBP	DRA	DR	3024BP	2	14 3/4	23 5/8
VS30BHBP	DFA	DF	PB30BP	1	29 5/8	5 13/16
VS30BP	DRA	DR	3021BP	2	14 3/4	20 5/8
VS30BP	DFA	DF	PB30BP	1	29 5/8	5 13/16
VS33	DRA	DR	3321	2	16 1/8	20 5/8
VS33	DFA	DF	PB33	2	16 1/8	5 13/16
VS33BH	DRA	DR	3324	2	16 1/8	23 5/8
VS33BH	DFA	DF	PB33	2	16 1/8	5 13/16
VS33BHBP	DRA	DR	3324BP	2	16 1/4	23 5/8
VS33BHBP	DFA	DF	PB33BP	1	32 5/8	5 13/16
VS33BP	DRA	DR	3321BP	2	16 1/4	20 5/8
VS33BP	DFA	DF	PB33BP	1	32 5/8	5 13/16
VS36	DRA	DR	1821	2	17 5/8	20 5/8
VS36	DFA	DF	PB18	2	17 5/8	5 13/16
VS36BH	DRA	DR	1824	2	17 5/8	23 5/8
VS36BH	DFA	DF	PB18	2	17 5/8	5 13/16
VS36BHBP	DRA	DR	3624BP	2	17 3/4	23 5/8
VS36BHBP	DFA	DF	PB36BP	1	35 5/8	5 13/16
VS36BP	DRA	DR	3621BP	2	17 3/4	20 5/8
VS36BP	DFA	DF	PB36BP	1	35 5/8	5 13/16
VS39	DRA	DR	3921	2	19 1/8	20 5/8
VS39	DFA	DF	PB39	2	19 1/8	5 13/16
VS39BH	DRA	DR	3924	2	19 1/8	23 5/8
VS39BH	DFA	DF	PB39	2	19 1/8	5 13/16
VS42	DRA	DR	2121	2	20 5/8	20 5/8
VS42	DFA	DF	PB21	2	20 5/8	5 13/16
VS42BH	DRA	DR	2124	2	20 5/8	23 5/8
VS42BH	DFA	DF	PB21	2	20 5/8	5 13/16
VS45BHBP	DRA	DR	4524BP	4	11	23 5/8
VS45BHBP	DFA	DF	PB45	2	22 1/8	5 13/16

SUPPLEMENTAL PARTS – FOL

SKU	MAP	TYPE	PART ID	QTY	WIDTH	HEIGHT
VS45BP	DRA	DR	4521BP	4	11	20 5/8
VS45BP	DFA	DF	PB45	2	22 1/8	5 13/16
VS48BHBP	DRA	DR	2424BP	4	11 3/4	23 5/8
VS48BHBP	DFA	DF	PB24	2	23 5/8	5 13/16
VS48BP	DRA	DR	2421BP	4	11 3/4	20 5/8
VS48BP	DFA	DF	PB24	2	23 5/8	5 13/16
VSD30BHLH	DRA	DR	1824	1	17 5/8	23 5/8
VSD30BHLH	DFA	DF	PB18	1	17 5/8	5 13/16
VSD30BHLH	DFB	DF	PB12	2	11 5/8	5 13/16
VSD30BHLH	DFC	DF	DB12	2	11 5/8	8 23/32
VSD30BHRH	DRA	DR	1824	1	17 5/8	23 5/8
VSD30BHRH	DFA	DF	PB18	1	17 5/8	5 13/16
VSD30BHRH	DFB	DF	PB12	2	11 5/8	5 13/16
VSD30BHRH	DFC	DF	DB12	2	11 5/8	8 23/32
VSD30LH	DRA	DR	1827	1	17 5/8	26 5/8
VSD30LH	DFA	DF	VD12	2	11 5/8	10 7/32
VSD30LH	DFB	DF	PB12	1	11 5/8	5 13/16
VSD30RH	DRA	DR	1827	1	17 5/8	26 5/8
VSD30RH	DFA	DF	VD12	2	11 5/8	10 7/32
VSD30RH	DFB	DF	PB12	1	11 5/8	5 13/16
VSD36BHLH	DRA	DR	2124	1	20 5/8	23 5/8
VSD36BHLH	DFA	DF	PB21	1	20 5/8	5 13/16
VSD36BHLH	DFB	DF	PB15	2	14 5/8	5 13/16
VSD36BHLH	DFC	DF	DB15	2	14 5/8	8 23/32
VSD36BHRH	DRA	DR	2124	1	20 5/8	23 5/8
VSD36BHRH	DFA	DF	PB21	1	20 5/8	5 13/16
VSD36BHRH	DFB	DF	PB15	2	14 5/8	5 13/16
VSD36BHRH	DFC	DF	DB15	2	14 5/8	8 23/32
VSD36LH	DRA	DR	2127	1	20 5/8	26 5/8
VSD36LH	DFA	DF	PB15	1	14 5/8	5 13/16
VSD36LH	DFB	DF	VD15	2	14 5/8	10 7/32
VSD36RH	DRA	DR	2127	1	20 5/8	26 5/8
VSD36RH	DFA	DF	PB15	1	14 5/8	5 13/16
VSD36RH	DFB	DF	VD15	2	14 5/8	10 7/32
VWC156	DRA	DR	1530	1	14 5/8	29 5/8
VWC2436	DRA	DR	2424BP	2	11 3/4	23 5/8
WC1224	DRA	DR	1224	1	11 5/8	23 5/8
WC1224	DRA	GL	1224	1	11 5/8	23 5/8
WC1224	DRA	MD	1224	1	11 5/8	23 5/8
WC1230	DRA	DR	1230	1	11 5/8	29 5/8
WC1230	DRA	GL	1230	1	11 5/8	29 5/8
WC1230	DRA	MD	1230	1	11 5/8	29 5/8
WC1236	DRA	DR	1236	1	11 5/8	35 5/8
WC1236	DRA	GL	1236	1	11 5/8	35 5/8
WC1236	DRA	MD	1236	1	11 5/8	35 5/8
WC1242	DRA	DR	1242	1	11 5/8	41 5/8
WC1242	DRA	GL	1242	1	11 5/8	41 5/8
WC1242	DRA	MD	1242	1	11 5/8	41 5/8
WC1524	DRA	DR	1524	1	14 5/8	23 5/8
WC1524	DRA	GL	1524	1	14 5/8	23 5/8
WC1524	DRA	MD	1524	1	14 5/8	23 5/8
WC1530	DRA	DR	1530	1	14 5/8	29 5/8
WC1530	DRA	GL	1530	1	14 5/8	29 5/8
WC1530	DRA	MD	1530	1	14 5/8	29 5/8
WC1536	DRA	DR	1536	1	14 5/8	35 5/8
WC1536	DRA	GL	1536	1	14 5/8	35 5/8
WC1536	DRA	MD	1536	1	14 5/8	35 5/8

SUPPLEMENTAL PARTS – FOL

SKU	MAP	TYPE	PART ID	QTY	WIDTH	HEIGHT
WC1542	DRA	DR	1542	1	14 5/8	41 5/8
WC1542	DRA	GL	1542	1	14 5/8	41 5/8
WC1542	DRA	MD	1542	1	14 5/8	41 5/8
WC1824	DRA	DR	1824	1	17 5/8	23 5/8
WC1824	DRA	GL	1824	1	17 5/8	23 5/8
WC1824	DRA	MD	1824	1	17 5/8	23 5/8
WC1830	DRA	DR	1830	1	17 5/8	29 5/8
WC1830	DRA	GL	1830	1	17 5/8	29 5/8
WC1830	DRA	MD	1830	1	17 5/8	29 5/8
WC1836	DRA	DR	1836	1	17 5/8	35 5/8
WC1836	DRA	GL	1836	1	17 5/8	35 5/8
WC1836	DRA	MD	1836	1	17 5/8	35 5/8
WC1842	DRA	DR	1842	1	17 5/8	41 5/8
WC1842	DRA	GL	1842	1	17 5/8	41 5/8
WC1842	DRA	MD	1842	1	17 5/8	41 5/8
WC2118	DRA	DR	2118	1	20 5/8	17 5/8
WC2118	DRA	GL	2118	1	20 5/8	17 5/8
WC2118	DRA	MD	2118	1	20 5/8	17 5/8
WC2124	DRA	DR	2124	1	20 5/8	23 5/8
WC2124	DRA	GL	2124	1	20 5/8	23 5/8
WC2124	DRA	MD	2124	1	20 5/8	23 5/8
WC2130	DRA	DR	2130	1	20 5/8	29 5/8
WC2130	DRA	GL	2130	1	20 5/8	29 5/8
WC2130	DRA	MD	2130	1	20 5/8	29 5/8
WC2136	DRA	DR	2136	1	20 5/8	35 5/8
WC2136	DRA	GL	2136	1	20 5/8	35 5/8
WC2136	DRA	MD	2136	1	20 5/8	35 5/8
WC2142	DRA	DR	2142	1	20 5/8	41 5/8
WC2142	DRA	GL	2142	1	20 5/8	41 5/8
WC2142	DRA	MD	2142	1	20 5/8	41 5/8
WC2418	DRA	DR	2418	1	23 5/8	17 5/8
WC2418	DRA	GL	2418	1	23 5/8	17 5/8
WC2418	DRA	MD	2418	1	23 5/8	17 5/8
WC2418BP	DRA	DR	2418BP	2	11 3/4	17 5/8
WC2418BP	DRA	GL	2418BP	2	11 3/4	17 5/8
WC2418BP	DRA	MD	2418BP	2	11 3/4	17 5/8
WC2424	DRA	DR	2424	1	23 5/8	23 5/8
WC2424	DRA	GL	2424	1	23 5/8	23 5/8
WC2424	DRA	MD	2424	1	23 5/8	23 5/8
WC2424BP	DRA	DR	2424BP	2	11 3/4	23 5/8
WC2424BP	DRA	GL	2424BP	2	11 3/4	23 5/8
WC2424BP	DRA	MD	2424BP	2	11 3/4	23 5/8
WC2430	DRA	DR	2430	1	23 5/8	29 5/8
WC2430	DRA	GL	2430	1	23 5/8	29 5/8
WC2430	DRA	MD	2430	1	23 5/8	29 5/8
WC2430BP	DRA	DR	2430BP	2	11 3/4	29 5/8
WC2430BP	DRA	GL	2430BP	2	11 3/4	29 5/8
WC2430BP	DRA	MD	2430BP	2	11 3/4	29 5/8
WC2436	DRA	DR	2436	1	23 5/8	35 5/8
WC2436	DRA	GL	2436	1	23 5/8	35 5/8
WC2436	DRA	MD	2436	1	23 5/8	35 5/8
WC2436BP	DRA	DR	2436BP	2	11 3/4	35 5/8
WC2436BP	DRA	GL	2436BP	2	11 3/4	35 5/8
WC2436BP	DRA	MD	2436BP	2	11 3/4	35 5/8
WC2442	DRA	DR	2442	1	23 5/8	41 5/8
WC2442	DRA	GL	2442	1	23 5/8	41 5/8
WC2442	DRA	MD	2442	1	23 5/8	41 5/8

SUPPLEMENTAL PARTS – FOL

SKU	MAP	TYPE	PART ID	QTY	WIDTH	HEIGHT
WC2442BP	DRA	DR	2442BP	2	11 3/4	41 5/8
WC2442BP	DRA	GL	2442BP	2	11 3/4	41 5/8
WC2442BP	DRA	MD	2442BP	2	11 3/4	41 5/8
WC2718	DRA	DR	2718	2	13 1/8	17 5/8
WC2718	DRA	GL	2718	2	13 1/8	17 5/8
WC2718	DRA	MD	2718	2	13 1/8	17 5/8
WC2718BP	DRA	DR	2718BP	2	13 1/4	17 5/8
WC2718BP	DRA	GL	2718BP	2	13 1/4	17 5/8
WC2718BP	DRA	MD	2718BP	2	13 1/4	17 5/8
WC2724	DRA	DR	2724	2	13 1/8	23 5/8
WC2724	DRA	GL	2724	2	13 1/8	23 5/8
WC2724	DRA	MD	2724	2	13 1/8	23 5/8
WC2724BP	DRA	DR	2724BP	2	13 1/4	23 5/8
WC2724BP	DRA	GL	2724BP	2	13 1/4	23 5/8
WC2724BP	DRA	MD	2724BP	2	13 1/4	23 5/8
WC2730	DRA	DR	2730	2	13 1/8	29 5/8
WC2730	DRA	GL	2730	2	13 1/8	29 5/8
WC2730	DRA	MD	2730	2	13 1/8	29 5/8
WC2730BP	DRA	DR	2730BP	2	13 1/4	29 5/8
WC2730BP	DRA	GL	2730BP	2	13 1/4	29 5/8
WC2730BP	DRA	MD	2730BP	2	13 1/4	29 5/8
WC2736	DRA	DR	2736	2	13 1/8	35 5/8
WC2736	DRA	GL	2736	2	13 1/8	35 5/8
WC2736	DRA	MD	2736	2	13 1/8	35 5/8
WC2736BP	DRA	DR	2736BP	2	13 1/4	35 5/8
WC2736BP	DRA	GL	2736BP	2	13 1/4	35 5/8
WC2736BP	DRA	MD	2736BP	2	13 1/4	35 5/8
WC2742	DRA	DR	2742	2	13 1/8	41 5/8
WC2742	DRA	GL	2742	2	13 1/8	41 5/8
WC2742	DRA	MD	2742	2	13 1/8	41 5/8
WC2742BP	DRA	DR	2742BP	2	13 1/4	41 5/8
WC2742BP	DRA	GL	2742BP	2	13 1/4	41 5/8
WC2742BP	DRA	MD	2742BP	2	13 1/4	41 5/8
WC3012	DRA	DR	1512	2	14 5/8	11 5/8
WC3012	DRA	GL	1512	2	14 5/8	11 5/8
WC3012	DRA	MD	1512	2	14 5/8	11 5/8
WC3012BP	DRA	DR	3012BP	2	14 3/4	11 5/8
WC3012BP	DRA	GL	3012BP	2	14 3/4	11 5/8
WC3012BP	DRA	MD	3012BP	2	14 3/4	11 5/8
WC3015	DRA	DR	1515	2	14 5/8	14 5/8
WC3015	DRA	GL	1515	2	14 5/8	14 5/8
WC3015	DRA	MD	1515	2	14 5/8	14 5/8
WC3015BP	DRA	DR	3015BP	2	14 3/4	14 5/8
WC3015BP	DRA	GL	3015BP	2	14 3/4	14 5/8
WC3015BP	DRA	MD	3015BP	2	14 3/4	14 5/8
WC3018	DRA	DR	1518	2	14 5/8	17 5/8
WC3018	DRA	GL	1518	2	14 5/8	17 5/8
WC3018	DRA	MD	1518	2	14 5/8	17 5/8
WC3018BP	DRA	DR	3018BP	2	14 3/4	17 5/8
WC3018BP	DRA	GL	3018BP	2	14 3/4	17 5/8
WC3018BP	DRA	MD	3018BP	2	14 3/4	17 5/8
WC3021	DRA	DR	1521	2	14 5/8	20 5/8
WC3021	DRA	GL	1521	2	14 5/8	20 5/8
WC3021	DRA	MD	1521	2	14 5/8	20 5/8
WC3021BP	DRA	DR	3021BP	2	14 3/4	20 5/8
WC3021BP	DRA	GL	3021BP	2	14 3/4	20 5/8
WC3021BP	DRA	MD	3021BP	2	14 3/4	20 5/8

SUPPLEMENTAL PARTS – FOL

SKU	MAP	TYPE	PART ID	QTY	WIDTH	HEIGHT
WC3024	DRA	DR	1524	2	14 5/8	23 5/8
WC3024	DRA	GL	1524	2	14 5/8	23 5/8
WC3024	DRA	MD	1524	2	14 5/8	23 5/8
WC3024BP	DRA	DR	3024BP	2	14 3/4	23 5/8
WC3024BP	DRA	GL	3024BP	2	14 3/4	23 5/8
WC3024BP	DRA	MD	3024BP	2	14 3/4	23 5/8
WC3027	DRA	DR	1527	2	14 5/8	26 5/8
WC3027	DRA	GL	1527	2	14 5/8	26 5/8
WC3027	DRA	MD	1527	2	14 5/8	26 5/8
WC3030	DRA	DR	1530	2	14 5/8	29 5/8
WC3030	DRA	GL	1530	2	14 5/8	29 5/8
WC3030	DRA	MD	1530	2	14 5/8	29 5/8
WC3030BP	DRA	DR	3030BP	2	14 3/4	29 5/8
WC3030BP	DRA	GL	3030BP	2	14 3/4	29 5/8
WC3030BP	DRA	MD	3030BP	2	14 3/4	29 5/8
WC3036	DRA	DR	1536	2	14 5/8	35 5/8
WC3036	DRA	GL	1536	2	14 5/8	35 5/8
WC3036	DRA	MD	1536	2	14 5/8	35 5/8
WC3036BP	DRA	DR	3036BP	2	14 3/4	35 5/8
WC3036BP	DRA	GL	3036BP	2	14 3/4	35 5/8
WC3036BP	DRA	MD	3036BP	2	14 3/4	35 5/8
WC3042	DRA	DR	1542	2	14 5/8	41 5/8
WC3042	DRA	GL	1542	2	14 5/8	41 5/8
WC3042	DRA	MD	1542	2	14 5/8	41 5/8
WC3042BP	DRA	DR	3042BP	2	14 3/4	41 5/8
WC3042BP	DRA	GL	3042BP	2	14 3/4	41 5/8
WC3042BP	DRA	MD	3042BP	2	14 3/4	41 5/8
WC3312	DRA	DR	3312	2	16 1/8	11 5/8
WC3312	DRA	GL	3312	2	16 1/8	11 5/8
WC3312	DRA	MD	3312	2	16 1/8	11 5/8
WC3312BP	DRA	DR	3312BP	2	16 1/4	11 5/8
WC3312BP	DRA	GL	3312BP	2	16 1/4	11 5/8
WC3312BP	DRA	MD	3312BP	2	16 1/4	11 5/8
WC3315	DRA	DR	3315	2	16 1/8	14 5/8
WC3315	DRA	GL	3315	2	16 1/8	14 5/8
WC3315	DRA	MD	3315	2	16 1/8	14 5/8
WC3315BP	DRA	DR	3315BP	2	16 1/4	14 5/8
WC3315BP	DRA	GL	3315BP	2	16 1/4	14 5/8
WC3315BP	DRA	MD	3315BP	2	16 1/4	14 5/8
WC3318	DRA	DR	3318	2	16 1/8	17 5/8
WC3318	DRA	GL	3318	2	16 1/8	17 5/8
WC3318	DRA	MD	3318	2	16 1/8	17 5/8
WC3318BP	DRA	DR	3318BP	2	16 1/4	17 5/8
WC3318BP	DRA	GL	3318BP	2	16 1/4	17 5/8
WC3318BP	DRA	MD	3318BP	2	16 1/4	17 5/8
WC3321	DRA	DR	3321	2	16 1/8	20 5/8
WC3321	DRA	GL	3321	2	16 1/8	20 5/8
WC3321	DRA	MD	3321	2	16 1/8	20 5/8
WC3321BP	DRA	DR	3321BP	2	16 1/4	20 5/8
WC3321BP	DRA	GL	3321BP	2	16 1/4	20 5/8
WC3321BP	DRA	MD	3321BP	2	16 1/4	20 5/8
WC3324	DRA	DR	3324	2	16 1/8	23 5/8
WC3324	DRA	GL	3324	2	16 1/8	23 5/8
WC3324	DRA	MD	3324	2	16 1/8	23 5/8
WC3324BP	DRA	DR	3324BP	2	16 1/4	23 5/8
WC3324BP	DRA	GL	3324BP	2	16 1/4	23 5/8
WC3324BP	DRA	MD	3324BP	2	16 1/4	23 5/8

SUPPLEMENTAL PARTS – FOL

SKU	MAP	TYPE	PART ID	QTY	WIDTH	HEIGHT
WC3330	DRA	DR	3330	2	16 1/8	29 5/8
WC3330	DRA	GL	3330	2	16 1/8	29 5/8
WC3330	DRA	MD	3330	2	16 1/8	29 5/8
WC3330BP	DRA	DR	3330BP	2	16 1/4	29 5/8
WC3330BP	DRA	GL	3330BP	2	16 1/4	29 5/8
WC3330BP	DRA	MD	3330BP	2	16 1/4	29 5/8
WC3336	DRA	DR	3336	2	16 1/8	35 5/8
WC3336	DRA	GL	3336	2	16 1/8	35 5/8
WC3336	DRA	MD	3336	2	16 1/8	35 5/8
WC3336BP	DRA	DR	3336BP	2	16 1/4	35 5/8
WC3336BP	DRA	GL	3336BP	2	16 1/4	35 5/8
WC3336BP	DRA	MD	3336BP	2	16 1/4	35 5/8
WC3342	DRA	DR	3342	2	16 1/8	41 5/8
WC3342	DRA	GL	3342	2	16 1/8	41 5/8
WC3342	DRA	MD	3342	2	16 1/8	41 5/8
WC3342BP	DRA	DR	3342BP	2	16 1/4	41 5/8
WC3342BP	DRA	GL	3342BP	2	16 1/4	41 5/8
WC3342BP	DRA	MD	3342BP	2	16 1/4	41 5/8
WC3612	DRA	DR	1812	2	17 5/8	11 5/8
WC3612	DRA	GL	1812	2	17 5/8	11 5/8
WC3612	DRA	MD	1812	2	17 5/8	11 5/8
WC3612BP	DRA	DR	3612BP	2	17 3/4	11 5/8
WC3612BP	DRA	GL	3612BP	2	17 3/4	11 5/8
WC3612BP	DRA	MD	3612BP	2	17 3/4	11 5/8
WC3615	DRA	DR	1815	2	17 5/8	14 5/8
WC3615	DRA	GL	1815	2	17 5/8	14 5/8
WC3615	DRA	MD	1815	2	17 5/8	14 5/8
WC3615BP	DRA	DR	3615BP	2	17 3/4	14 5/8
WC3615BP	DRA	GL	3615BP	2	17 3/4	14 5/8
WC3615BP	DRA	MD	3615BP	2	17 3/4	14 5/8
WC3618	DRA	DR	1818	2	17 5/8	17 5/8
WC3618	DRA	GL	1818	2	17 5/8	17 5/8
WC3618	DRA	MD	1818	2	17 5/8	17 5/8
WC3618BP	DRA	DR	3618BP	2	17 3/4	17 5/8
WC3618BP	DRA	GL	3618BP	2	17 3/4	17 5/8
WC3618BP	DRA	MD	3618BP	2	17 3/4	17 5/8
WC3621	DRA	DR	1821	2	17 5/8	20 5/8
WC3621	DRA	GL	1821	2	17 5/8	20 5/8
WC3621	DRA	MD	1821	2	17 5/8	20 5/8
WC3621BP	DRA	DR	3621BP	2	17 3/4	20 5/8
WC3621BP	DRA	GL	3621BP	2	17 3/4	20 5/8
WC3621BP	DRA	MD	3621BP	2	17 3/4	20 5/8
WC3624	DRA	DR	1824	2	17 5/8	23 5/8
WC3624	DRA	GL	1824	2	17 5/8	23 5/8
WC3624	DRA	MD	1824	2	17 5/8	23 5/8
WC3624BP	DRA	DR	3624BP	2	17 3/4	23 5/8
WC3624BP	DRA	GL	3624BP	2	17 3/4	23 5/8
WC3624BP	DRA	MD	3624BP	2	17 3/4	23 5/8
WC3630	DRA	DR	1830	2	17 5/8	29 5/8
WC3630	DRA	GL	1830	2	17 5/8	29 5/8
WC3630	DRA	MD	1830	2	17 5/8	29 5/8
WC3630BP	DRA	DR	3630BP	2	17 3/4	29 5/8
WC3630BP	DRA	GL	3630BP	2	17 3/4	29 5/8
WC3630BP	DRA	MD	3630BP	2	17 3/4	29 5/8
WC3636	DRA	DR	1836	2	17 5/8	35 5/8
WC3636	DRA	GL	1836	2	17 5/8	35 5/8
WC3636	DRA	MD	1836	2	17 5/8	35 5/8

SUPPLEMENTAL PARTS – FOL

SKU	MAP	TYPE	PART ID	QTY	WIDTH	HEIGHT
WC3636BP	DRA	DR	3636BP	2	17 3/4	35 5/8
WC3636BP	DRA	GL	3636BP	2	17 3/4	35 5/8
WC3636BP	DRA	MD	3636BP	2	17 3/4	35 5/8
WC3642	DRA	DR	1842	2	17 5/8	41 5/8
WC3642	DRA	GL	1842	2	17 5/8	41 5/8
WC3642	DRA	MD	1842	2	17 5/8	41 5/8
WC3642BP	DRA	DR	3642BP	2	17 3/4	41 5/8
WC3642BP	DRA	GL	3642BP	2	17 3/4	41 5/8
WC3642BP	DRA	MD	3642BP	2	17 3/4	41 5/8
WC3912	DRA	DR	3912	2	19 1/8	11 5/8
WC3912	DRA	GL	3912	2	19 1/8	11 5/8
WC3912	DRA	MD	3912	2	19 1/8	11 5/8
WC3912BP	DRA	DR	3912BP	2	19 1/4	11 5/8
WC3912BP	DRA	GL	3912BP	2	19 1/4	11 5/8
WC3912BP	DRA	MD	3912BP	2	19 1/4	11 5/8
WC3915	DRA	DR	3915	2	19 1/8	14 5/8
WC3915	DRA	GL	3915	2	19 1/8	14 5/8
WC3915	DRA	MD	3915	2	19 1/8	14 5/8
WC3915BP	DRA	DR	3915BP	2	19 1/4	14 5/8
WC3915BP	DRA	GL	3915BP	2	19 1/4	14 5/8
WC3915BP	DRA	MD	3915BP	2	19 1/4	14 5/8
WC3918	DRA	DR	3918	2	19 1/8	17 5/8
WC3918	DRA	GL	3918	2	19 1/8	17 5/8
WC3918	DRA	MD	3918	2	19 1/8	17 5/8
WC3918BP	DRA	DR	3918BP	2	19 1/4	17 5/8
WC3918BP	DRA	GL	3918BP	2	19 1/4	17 5/8
WC3918BP	DRA	MD	3918BP	2	19 1/4	17 5/8
WC3921	DRA	DR	3921	2	19 1/8	20 5/8
WC3921	DRA	GL	3921	2	19 1/8	20 5/8
WC3921	DRA	MD	3921	2	19 1/8	20 5/8
WC3921BP	DRA	DR	3921BP	2	19 1/4	20 5/8
WC3921BP	DRA	GL	3921BP	2	19 1/4	20 5/8
WC3921BP	DRA	MD	3921BP	2	19 1/4	20 5/8
WC3924	DRA	DR	3924	2	19 1/8	23 5/8
WC3924	DRA	GL	3924	2	19 1/8	23 5/8
WC3924	DRA	MD	3924	2	19 1/8	23 5/8
WC3924BP	DRA	DR	3924BP	2	19 1/4	23 5/8
WC3924BP	DRA	GL	3924BP	2	19 1/4	23 5/8
WC3924BP	DRA	MD	3924BP	2	19 1/4	23 5/8
WC3930	DRA	DR	3930	2	19 1/8	29 5/8
WC3930	DRA	GL	3930	2	19 1/8	29 5/8
WC3930	DRA	MD	3930	2	19 1/8	29 5/8
WC3936	DRA	DR	3936	2	19 1/8	35 5/8
WC3936	DRA	GL	3936	2	19 1/8	35 5/8
WC3936	DRA	MD	3936	2	19 1/8	35 5/8
WC3942	DRA	DR	3942	2	19 1/8	41 5/8
WC3942	DRA	GL	3942	2	19 1/8	41 5/8
WC3942	DRA	MD	3942	2	19 1/8	41 5/8
WC4218	DRA	DR	2118	2	20 5/8	17 5/8
WC4218	DRA	GL	2118	2	20 5/8	17 5/8
WC4218	DRA	MD	2118	2	20 5/8	17 5/8
WC4224	DRA	DR	2124	2	20 5/8	23 5/8
WC4224	DRA	GL	2124	2	20 5/8	23 5/8
WC4224	DRA	MD	2124	2	20 5/8	23 5/8
WC4230	DRA	DR	2130	2	20 5/8	29 5/8
WC4230	DRA	GL	2130	2	20 5/8	29 5/8
WC4230	DRA	MD	2130	2	20 5/8	29 5/8

SUPPLEMENTAL PARTS – FOL

SKU	MAP	TYPE	PART ID	QTY	WIDTH	HEIGHT
WC4236	DRA	DR	2136	2	20 5/8	35 5/8
WC4236	DRA	GL	2136	2	20 5/8	35 5/8
WC4236	DRA	MD	2136	2	20 5/8	35 5/8
WC4242	DRA	DR	2142	2	20 5/8	41 5/8
WC4242	DRA	GL	2142	2	20 5/8	41 5/8
WC4242	DRA	MD	2142	2	20 5/8	41 5/8
WC4524	DRA	DR	4524	2	22 1/8	23 5/8
WC4524	DRA	GL	4524	2	22 1/8	23 5/8
WC4524	DRA	MD	4524	2	22 1/8	23 5/8
WC4530	DRA	DR	4530	2	22 1/8	29 5/8
WC4530	DRA	GL	4530	2	22 1/8	29 5/8
WC4530	DRA	MD	4530	2	22 1/8	29 5/8
WC4536	DRA	DR	4536	2	22 1/8	35 5/8
WC4536	DRA	GL	4536	2	22 1/8	35 5/8
WC4536	DRA	MD	4536	2	22 1/8	35 5/8
WC4542	DRA	DR	4542	2	22 1/8	41 5/8
WC4542	DRA	GL	4542	2	22 1/8	41 5/8
WC4542	DRA	MD	4542	2	22 1/8	41 5/8
WC4824	DRA	DR	2424	2	23 5/8	23 5/8
WC4824	DRA	GL	2424	2	23 5/8	23 5/8
WC4824	DRA	MD	2424	2	23 5/8	23 5/8
WC4830	DRA	DR	2430	2	23 5/8	29 5/8
WC4830	DRA	GL	2430	2	23 5/8	29 5/8
WC4830	DRA	MD	2430	2	23 5/8	29 5/8
WC4836	DRA	DR	2436	2	23 5/8	35 5/8
WC4836	DRA	GL	2436	2	23 5/8	35 5/8
WC4836	DRA	MD	2436	2	23 5/8	35 5/8
WC4842	DRA	DR	2442	2	23 5/8	41 5/8
WC4842	DRA	GL	2442	2	23 5/8	41 5/8
WC4842	DRA	MD	2442	2	23 5/8	41 5/8
WC924	DRA	DR	924	1	8 5/8	23 5/8
WC924	DRA	GL	924	1	8 5/8	23 5/8
WC930	DRA	DR	930	1	8 5/8	29 5/8
WC930	DRA	GL	930	1	8 5/8	29 5/8
WC936	DRA	DR	936	1	8 5/8	35 5/8
WC936	DRA	GL	936	1	8 5/8	35 5/8
WC942	DRA	DR	942	1	8 5/8	41 5/8
WC942	DRA	GL	942	1	8 5/8	41 5/8
WCC2424	DRA	DR	1224	1	11 5/8	23 5/8
WCC2424	DRA	GL	1224	1	11 5/8	23 5/8
WCC2424	DRA	MD	1224	1	11 5/8	23 5/8
WCC2430	DRA	DR	1230	1	11 5/8	29 5/8
WCC2430	DRA	GL	1230	1	11 5/8	29 5/8
WCC2430	DRA	MD	1230	1	11 5/8	29 5/8
WCC2436	DRA	DR	1236	1	11 5/8	35 5/8
WCC2436	DRA	GL	1236	1	11 5/8	35 5/8
WCC2436	DRA	MD	1236	1	11 5/8	35 5/8
WCC2442	DRA	DR	1242	1	11 5/8	41 5/8
WCC2442	DRA	GL	1242	1	11 5/8	41 5/8
WCC2442	DRA	MD	1242	1	11 5/8	41 5/8
WCC3024	DRA	DR	1824	1	17 5/8	23 5/8
WCC3024	DRA	GL	1824	1	17 5/8	23 5/8
WCC3024	DRA	MD	1824	1	17 5/8	23 5/8
WCC3030	DRA	DR	1830	1	17 5/8	29 5/8
WCC3030	DRA	GL	1830	1	17 5/8	29 5/8
WCC3030	DRA	MD	1830	1	17 5/8	29 5/8

SUPPLEMENTAL PARTS – FOL

SKU	MAP	TYPE	PART ID	QTY	WIDTH	HEIGHT
WCC3036	DRA	DR	1836	1	17 5/8	35 5/8
WCC3036	DRA	GL	1836	1	17 5/8	35 5/8
WCC3036	DRA	MD	1836	1	17 5/8	35 5/8
WCC3042	DRA	DR	1842	1	17 5/8	41 5/8
WCC3042	DRA	GL	1842	1	17 5/8	41 5/8
WCC3042	DRA	MD	1842	1	17 5/8	41 5/8
WCC3624	DRA	DR	2424	1	23 5/8	23 5/8
WCC3624	DRA	GL	2424	1	23 5/8	23 5/8
WCC3624	DRA	MD	2424	1	23 5/8	23 5/8
WCC3630	DRA	DR	2430	1	23 5/8	29 5/8
WCC3630	DRA	GL	2430	1	23 5/8	29 5/8
WCC3630	DRA	MD	2430	1	23 5/8	29 5/8
WCC3636	DRA	DR	2436	1	23 5/8	35 5/8
WCC3636	DRA	GL	2436	1	23 5/8	35 5/8
WCC3636	DRA	MD	2436	1	23 5/8	35 5/8
WCC3642	DRA	DR	2442	1	23 5/8	41 5/8
WCC3642	DRA	GL	2442	1	23 5/8	41 5/8
WCC3642	DRA	MD	2442	1	23 5/8	41 5/8
WCC4230	DRA	DR	1530	2	14 5/8	29 5/8
WCC4230	DRA	GL	1530	2	14 5/8	29 5/8
WCC4230	DRA	MD	1530	2	14 5/8	29 5/8
WCC4236	DRA	DR	1536	2	14 5/8	35 5/8
WCC4236	DRA	GL	1536	2	14 5/8	35 5/8
WCC4236	DRA	MD	1536	2	14 5/8	35 5/8
WCC4242	DRA	DR	1542	2	14 5/8	41 5/8
WCC4242	DRA	GL	1542	2	14 5/8	41 5/8
WCC4242	DRA	MD	1542	2	14 5/8	41 5/8
WCC4830	DRA	DR	1830	2	17 5/8	29 5/8
WCC4830	DRA	GL	1830	2	17 5/8	29 5/8
WCC4830	DRA	MD	1830	2	17 5/8	29 5/8
WCC4836	DRA	DR	1836	2	17 5/8	35 5/8
WCC4836	DRA	GL	1836	2	17 5/8	35 5/8
WCC4836	DRA	MD	1836	2	17 5/8	35 5/8
WCC4842	DRA	DR	1842	2	17 5/8	41 5/8
WCC4842	DRA	GL	1842	2	17 5/8	41 5/8
WCC4842	DRA	MD	1842	2	17 5/8	41 5/8
WCMW2730	DRA	DR	2712	2	13 1/8	11 5/8
WCMW2730	DRA	GL	2712	2	13 1/8	11 5/8
WCMW2730	DRA	MD	2712	2	13 1/8	11 5/8
WCMW2730BP	DRA	DR	2712BP	2	13 1/4	11 5/8
WCMW2730BP	DRA	GL	2712BP	2	13 1/4	11 5/8
WCMW2730BP	DRA	MD	2712BP	2	13 1/4	11 5/8
WCMW2736	DRA	DR	2718	2	13 1/8	17 5/8
WCMW2736	DRA	GL	2718	2	13 1/8	17 5/8
WCMW2736	DRA	MD	2718	2	13 1/8	17 5/8
WCMW2736BP	DRA	DR	2718BP	2	13 1/4	17 5/8
WCMW2736BP	DRA	GL	2718BP	2	13 1/4	17 5/8
WCMW2736BP	DRA	MD	2718BP	2	13 1/4	17 5/8
WCMW2742	DRA	DR	2724	2	13 1/8	23 5/8
WCMW2742	DRA	GL	2724	2	13 1/8	23 5/8
WCMW2742	DRA	MD	2724	2	13 1/8	23 5/8
WCMW2742BP	DRA	DR	2724BP	2	13 1/4	23 5/8
WCMW2742BP	DRA	GL	2724BP	2	13 1/4	23 5/8
WCMW2742BP	DRA	MD	2724BP	2	13 1/4	23 5/8
WCMW3030	DRA	DR	1512	2	14 5/8	11 5/8
WCMW3030	DRA	GL	1512	2	14 5/8	11 5/8
WCMW3030	DRA	MD	1512	2	14 5/8	11 5/8

SUPPLEMENTAL PARTS – FOL

SKU	MAP	TYPE	PART ID	QTY	WIDTH	HEIGHT
WCMW3030BP	DRA	DR	3012BP	2	14 3/4	11 5/8
WCMW3030BP	DRA	GL	3012BP	2	14 3/4	11 5/8
WCMW3030BP	DRA	MD	3012BP	2	14 3/4	11 5/8
WCMW3036	DRA	DR	1518	2	14 5/8	17 5/8
WCMW3036	DRA	GL	1518	2	14 5/8	17 5/8
WCMW3036	DRA	MD	1518	2	14 5/8	17 5/8
WCMW3036BP	DRA	DR	3018BP	2	14 3/4	17 5/8
WCMW3036BP	DRA	GL	3018BP	2	14 3/4	17 5/8
WCMW3036BP	DRA	MD	3018BP	2	14 3/4	17 5/8
WCMW3042	DRA	DR	1524	2	14 5/8	23 5/8
WCMW3042	DRA	GL	1524	2	14 5/8	23 5/8
WCMW3042	DRA	MD	1524	2	14 5/8	23 5/8
WCMW3042BP	DRA	DR	3024BP	2	14 3/4	23 5/8
WCMW3042BP	DRA	GL	3024BP	2	14 3/4	23 5/8
WCMW3042BP	DRA	MD	3024BP	2	14 3/4	23 5/8
WEA1224	DRA	DR	924	2	8 5/8	23 5/8
WEA1224	DRA	GL	924	2	8 5/8	23 5/8
WEA1230	DRA	DR	930	2	8 5/8	29 5/8
WEA1230	DRA	GL	930	2	8 5/8	29 5/8
WEA1236	DRA	DR	936	2	8 5/8	35 5/8
WEA1236	DRA	GL	936	2	8 5/8	35 5/8
WEA1242	DRA	DR	942	2	8 5/8	41 5/8
WEA1242	DRA	GL	942	2	8 5/8	41 5/8
WEC1224	DRA	DR	WEC24	1	15 1/4	23 5/8
WEC1224	DRA	GL	WEC24	1	15 1/4	23 5/8
WEC1224	DRA	MD	WEC24	1	15 1/4	23 5/8
WEC1230	DRA	DR	WEC30	1	15 1/4	29 5/8
WEC1230	DRA	GL	WEC30	1	15 1/4	29 5/8
WEC1230	DRA	MD	WEC30	1	15 1/4	29 5/8
WEC1236	DRA	DR	WEC36	1	15 1/4	35 5/8
WEC1236	DRA	GL	WEC36	1	15 1/4	35 5/8
WEC1236	DRA	MD	WEC36	1	15 1/4	35 5/8
WEC1242	DRA	DR	WEC42	1	15 1/4	41 5/8
WEC1242	DRA	GL	WEC42	1	15 1/4	41 5/8
WEC1242	DRA	MD	WEC42	1	15 1/4	41 5/8

Glass Cut For Size

SUPPLEMENTAL PARTS – GLASS

		BELWOOD, CAMBRIDGE, ATLANTA, BRUNSWICK, FLORENCE, PARKWOOD		FAIRMONT		SAVANNAH, JAMESTON, WILMINGTON, CHARLESTON, ARLINGTON, NANTUCKET		SUMMERFIELD, JEFFERSON, WENTWORTH, ARDMORE, TRENTON, NORTHBROOK, ARCADIA	
SKU	TYPE	WIDTH	HEIGHT	WIDTH	HEIGHT	WIDTH	HEIGHT	WIDTH	HEIGHT
CWC2424	GL	11 5/8	18 5/8	10 3/4	17 3/4	11 3/4	20 1/4	10 1/8	18 5/8
CWC2424	MD	11 5/8	18 5/8	10 3/4	17 3/4	11 3/4	20 1/4	10 1/8	18 5/8
CWC2430	GL	11 5/8	24 5/8	10 3/4	23 3/4	11 3/4	26 1/4	10 1/8	24 5/8
CWC2430	MD	11 5/8	24 5/8	10 3/4	23 3/4	11 3/4	26 1/4	10 1/8	24 5/8
CWC2436	GL	11 5/8	30 5/8	10 3/4	29 3/4	11 3/4	32 1/4	10 1/8	30 5/8
CWC2436	MD	11 5/8	30 5/8	10 3/4	29 3/4	11 3/4	32 1/4	10 1/8	30 5/8
CWC2442	GL	11 5/8	36 5/8	10 3/4	35 3/4	11 3/4	38 1/4	10 1/8	36 5/8
CWC2442	MD	11 5/8	36 5/8	10 3/4	35 3/4	11 3/4	38 1/4	10 1/8	36 5/8
CWC2724	GL	11 5/8	18 5/8	10 3/4	17 3/4	11 3/4	20 1/4	10 1/8	18 5/8
CWC2724	MD	11 5/8	18 5/8	10 3/4	17 3/4	11 3/4	20 1/4	10 1/8	18 5/8
CWC2730	GL	11 5/8	24 5/8	10 3/4	23 3/4	11 3/4	26 1/4	10 1/8	24 5/8
CWC2730	MD	11 5/8	24 5/8	10 3/4	23 3/4	11 3/4	26 1/4	10 1/8	24 5/8
CWC2736	GL	11 5/8	30 5/8	10 3/4	29 3/4	11 3/4	32 1/4	10 1/8	30 5/8
CWC2736	MD	11 5/8	30 5/8	10 3/4	29 3/4	11 3/4	32 1/4	10 1/8	30 5/8
CWC2742	GL	11 5/8	36 5/8	10 3/4	35 3/4	11 3/4	38 1/4	10 1/8	36 5/8
CWC2742	MD	11 5/8	36 5/8	10 3/4	35 3/4	11 3/4	38 1/4	10 1/8	36 5/8
IW3018	GL	9 5/8	12 5/8	8 3/4	11 3/4	11 1/4	14 1/4	9 5/8	12 5/8
IW3018	MD	9 5/8	12 5/8	8 3/4	11 3/4	11 1/4	14 1/4	9 5/8	12 5/8
IW3018BP	GL	10 9/16	12 5/8	9 11/16	11 3/4	11 3/8	14 1/4	9 3/4	12 5/8
IW3018BP	MD	10 9/16	12 5/8	9 11/16	11 3/4	11 3/8	14 1/4	9 3/4	12 5/8
IW3030	GL	9 5/8	24 5/8	8 3/4	23 3/4	11 1/4	26 1/4	9 5/8	24 5/8
IW3030	MD	9 5/8	24 5/8	8 3/4	23 3/4	11 1/4	26 1/4	9 5/8	24 5/8
IW3030BP	GL	10 9/16	24 5/8	9 11/16	23 3/4	11 3/8	26 1/4	9 3/4	24 5/8
IW3030BP	MD	10 9/16	24 5/8	9 11/16	23 3/4	11 3/8	26 1/4	9 3/4	24 5/8
RW3012	GL	9 5/8	6 5/8	8 3/4	5 3/4	11 1/4	8 1/4	9 5/8	6 5/8
RW3012	MD	9 5/8	6 5/8	8 3/4	5 3/4	11 1/4	8 1/4	9 5/8	6 5/8
RW3015	GL	9 5/8	9 5/8	8 3/4	8 3/4	11 1/4	11 1/4	9 5/8	9 5/8
RW3015	MD	9 5/8	9 5/8	8 3/4	8 3/4	11 1/4	11 1/4	9 5/8	9 5/8
RW3018	GL	9 5/8	12 5/8	8 3/4	11 3/4	11 1/4	14 1/4	9 5/8	12 5/8
RW3018	MD	9 5/8	12 5/8	8 3/4	11 3/4	11 1/4	14 1/4	9 5/8	12 5/8
RW3021	GL	9 5/8	15 5/8	8 3/4	14 3/4	11 1/4	17 1/4	9 5/8	15 5/8
RW3021	MD	9 5/8	15 5/8	8 3/4	14 3/4	11 1/4	17 1/4	9 5/8	15 5/8
RW3024	GL	9 5/8	18 5/8	8 3/4	17 3/4	11 1/4	20 1/4	9 5/8	18 5/8
RW3024	MD	9 5/8	18 5/8	8 3/4	17 3/4	11 1/4	20 1/4	9 5/8	18 5/8
RW3312	GL	11 1/8	6 5/8	10 1/4	5 3/4	12 3/4	8 1/4	11 1/8	6 5/8
RW3312	MD	11 1/8	6 5/8	10 1/4	5 3/4	12 3/4	8 1/4	11 1/8	6 5/8
RW3315	GL	11 1/8	9 5/8	10 1/4	8 3/4	12 3/4	11 1/4	11 1/8	9 5/8
RW3315	MD	11 1/8	9 5/8	10 1/4	8 3/4	12 3/4	11 1/4	11 1/8	9 5/8
RW3318	GL	11 1/8	12 5/8	10 1/4	11 3/4	12 3/4	14 1/4	11 1/8	12 5/8
RW3318	MD	11 1/8	12 5/8	10 1/4	11 3/4	12 3/4	14 1/4	11 1/8	12 5/8
RW3321	GL	11 1/8	15 5/8	10 1/4	14 3/4	12 3/4	17 1/4	11 1/8	15 5/8
RW3321	MD	11 1/8	15 5/8	10 1/4	14 3/4	12 3/4	17 1/4	11 1/8	15 5/8
RW3324	GL	11 1/8	18 5/8	10 1/4	17 3/4	12 3/4	20 1/4	11 1/8	18 5/8
RW3324	MD	11 1/8	18 5/8	10 1/4	17 3/4	12 3/4	20 1/4	11 1/8	18 5/8
RW3612	GL	12 5/8	6 5/8	11 3/4	5 3/4	14 1/4	8 1/4	12 5/8	6 5/8
RW3612	MD	12 5/8	6 5/8	11 3/4	5 3/4	14 1/4	8 1/4	12 5/8	6 5/8
RW3615	GL	12 5/8	9 5/8	11 3/4	8 3/4	14 1/4	11 1/4	12 5/8	9 5/8
RW3615	MD	12 5/8	9 5/8	11 3/4	8 3/4	14 1/4	11 1/4	12 5/8	9 5/8
RW3618	GL	12 5/8	12 5/8	11 3/4	11 3/4	14 1/4	14 1/4	12 5/8	12 5/8
RW3618	MD	12 5/8	12 5/8	11 3/4	11 3/4	14 1/4	14 1/4	12 5/8	12 5/8

SUPPLEMENTAL PARTS – GLASS

		BELWOOD, CAMBRIDGE, ATLANTA, BRUNSWICK, FLORENCE, PARKWOOD		FAIRMONT		SAVANNAH, JAMESTON, WILMINGTON, CHARLESTON, ARLINGTON, NANTUCKET		SUMMERFIELD, JEFFERSON, WENTWORTH, ARDMORE, TRENTON, NORTHBROOK, ARCADIA	
SKU	TYPE	WIDTH	HEIGHT	WIDTH	HEIGHT	WIDTH	HEIGHT	WIDTH	HEIGHT
RW3621	GL	12 5/8	15 5/8	11 3/4	14 3/4	14 1/4	17 1/4	12 5/8	15 5/8
RW3621	MD	12 5/8	15 5/8	11 3/4	14 3/4	14 1/4	17 1/4	12 5/8	15 5/8
RW3624	GL	12 5/8	18 5/8	11 3/4	17 3/4	14 1/4	20 1/4	12 5/8	18 5/8
RW3624	MD	12 5/8	18 5/8	11 3/4	17 3/4	14 1/4	20 1/4	12 5/8	18 5/8
RW3912	GL	14 1/8	6 5/8	13 1/4	5 3/4	15 3/4	8 1/4	14 1/8	6 5/8
RW3912	MD	14 1/8	6 5/8	13 1/4	5 3/4	15 3/4	8 1/4	14 1/8	6 5/8
RW3915	GL	14 1/8	9 5/8	13 1/4	8 3/4	15 3/4	11 1/4	14 1/8	9 5/8
RW3915	MD	14 1/8	9 5/8	13 1/4	8 3/4	15 3/4	11 1/4	14 1/8	9 5/8
RW3918	GL	14 1/8	12 5/8	13 1/4	11 3/4	15 3/4	14 1/4	14 1/8	12 5/8
RW3918	MD	14 1/8	12 5/8	13 1/4	11 3/4	15 3/4	14 1/4	14 1/8	12 5/8
RW3921	GL	14 1/8	15 5/8	13 1/4	14 3/4	15 3/4	17 1/4	14 1/8	15 5/8
RW3921	MD	14 1/8	15 5/8	13 1/4	14 3/4	15 3/4	17 1/4	14 1/8	15 5/8
RW3924	GL	14 1/8	18 5/8	13 1/4	17 3/4	15 3/4	20 1/4	14 1/8	18 5/8
RW3924	MD	14 1/8	18 5/8	13 1/4	17 3/4	15 3/4	20 1/4	14 1/8	18 5/8
RW4212	GL	15 5/8	6 5/8	14 3/4	5 3/4	17 1/4	8 1/4	15 5/8	6 5/8
RW4212	MD	15 5/8	6 5/8	14 3/4	5 3/4	17 1/4	8 1/4	15 5/8	6 5/8
RW4215	GL	15 5/8	9 5/8	14 3/4	8 3/4	17 1/4	11 1/4	15 5/8	9 5/8
RW4215	MD	15 5/8	9 5/8	14 3/4	8 3/4	17 1/4	11 1/4	15 5/8	9 5/8
RW4218	GL	15 5/8	12 5/8	14 3/4	11 3/4	17 1/4	14 1/4	15 5/8	12 5/8
RW4218	MD	15 5/8	12 5/8	14 3/4	11 3/4	17 1/4	14 1/4	15 5/8	12 5/8
RW4221	GL	15 5/8	15 5/8	14 3/4	14 3/4	17 1/4	17 1/4	15 5/8	15 5/8
RW4221	MD	15 5/8	15 5/8	14 3/4	14 3/4	17 1/4	17 1/4	15 5/8	15 5/8
RW4224	GL	15 5/8	18 5/8	14 3/4	17 3/4	17 1/4	20 1/4	15 5/8	18 5/8
RW4224	MD	15 5/8	18 5/8	14 3/4	17 3/4	17 1/4	20 1/4	15 5/8	18 5/8
RW4512BP	GL	6 13/16	6 5/8	5 15/16	5 3/4	7 5/8	8 1/4	6	6 5/8
RW4512BP	MD	6 13/16	6 5/8	5 15/16	5 3/4	7 5/8	8 1/4	6	6 5/8
RW4515BP	GL	6 13/16	9 5/8	5 15/16	8 3/4	7 5/8	11 1/4	6	9 5/8
RW4515BP	MD	6 13/16	9 5/8	5 15/16	8 3/4	7 5/8	11 1/4	6	9 5/8
RW4518BP	GL	6 13/16	12 5/8	5 15/16	11 3/4	7 5/8	14 1/4	6	12 5/8
RW4518BP	MD	6 13/16	12 5/8	5 15/16	11 3/4	7 5/8	14 1/4	6	12 5/8
RW4521BP	GL	6 13/16	15 5/8	5 15/16	14 3/4	7 5/8	17 1/4	6	15 5/8
RW4521BP	MD	6 13/16	15 5/8	5 15/16	14 3/4	7 5/8	17 1/4	6	15 5/8
RW4524BP	GL	6 13/16	18 5/8	5 15/16	17 3/4	7 5/8	20 1/4	6	18 5/8
RW4524BP	MD	6 13/16	18 5/8	5 15/16	17 3/4	7 5/8	20 1/4	6	18 5/8
RW4812BP	GL	7 9/16	6 5/8	6 11/16	5 3/4	8 3/8	8 1/4	6 3/4	6 5/8
RW4812BP	MD	7 9/16	6 5/8	6 11/16	5 3/4	8 3/8	8 1/4	6 3/4	6 5/8
RW4815BP	GL	7 9/16	9 5/8	6 11/16	8 3/4	8 3/8	11 1/4	6 3/4	9 5/8
RW4815BP	MD	7 9/16	9 5/8	6 11/16	8 3/4	8 3/8	11 1/4	6 3/4	9 5/8
RW4818BP	GL	7 9/16	12 5/8	6 11/16	11 3/4	8 3/8	14 1/4	6 3/4	12 5/8
RW4818BP	MD	7 9/16	12 5/8	6 11/16	11 3/4	8 3/8	14 1/4	6 3/4	12 5/8
RW4821BP	GL	7 9/16	15 5/8	6 11/16	14 3/4	8 3/8	17 1/4	6 3/4	15 5/8
RW4821BP	MD	7 9/16	15 5/8	6 11/16	14 3/4	8 3/8	17 1/4	6 3/4	15 5/8
RW4824BP	GL	7 9/16	18 5/8	6 11/16	17 3/4	8 3/8	20 1/4	6 3/4	18 5/8
RW4824BP	MD	7 9/16	18 5/8	6 11/16	17 3/4	8 3/8	20 1/4	6 3/4	18 5/8
WC1224	GL	6 5/8	18 5/8	5 3/4	17 3/4	8 1/4	20 1/4	6 5/8	18 5/8
WC1224	MD	6 5/8	18 5/8	5 3/4	17 3/4	8 1/4	20 1/4	6 5/8	18 5/8
WC1230	GL	6 5/8	24 5/8	5 3/4	23 3/4	8 1/4	26 1/4	6 5/8	24 5/8
WC1230	MD	6 5/8	24 5/8	5 3/4	23 3/4	8 1/4	26 1/4	6 5/8	24 5/8
WC1236	GL	6 5/8	30 5/8	5 3/4	29 3/4	8 1/4	32 1/4	6 5/8	30 5/8
WC1236	MD	6 5/8	30 5/8	5 3/4	29 3/4	8 1/4	32 1/4	6 5/8	30 5/8

SUPPLEMENTAL PARTS – GLASS

		BELWOOD, CAMBRIDGE, ATLANTA, BRUNSWICK, FLORENCE, PARKWOOD		FAIRMONT		SAVANNAH, JAMESTON, WILMINGTON, CHARLESTON, ARLINGTON, NANTUCKET		SUMMERFIELD, JEFFERSON, WENTWORTH, ARDMORE, TRENTON, NORTHBROOK, ARCADIA	
SKU	TYPE	WIDTH	HEIGHT	WIDTH	HEIGHT	WIDTH	HEIGHT	WIDTH	HEIGHT
WC1242	GL	6 5/8	36 5/8	5 3/4	35 3/4	8 1/4	38 1/4	6 5/8	36 5/8
WC1242	MD	6 5/8	36 5/8	5 3/4	35 3/4	8 1/4	38 1/4	6 5/8	36 5/8
WC1524	GL	9 5/8	18 5/8	8 3/4	17 3/4	11 1/4	20 1/4	9 5/8	18 5/8
WC1524	MD	9 5/8	18 5/8	8 3/4	17 3/4	11 1/4	20 1/4	9 5/8	18 5/8
WC1530	GL	9 5/8	24 5/8	8 3/4	23 3/4	11 1/4	26 1/4	9 5/8	24 5/8
WC1530	MD	9 5/8	24 5/8	8 3/4	23 3/4	11 1/4	26 1/4	9 5/8	24 5/8
WC1536	GL	9 5/8	30 5/8	8 3/4	29 3/4	11 1/4	32 1/4	9 5/8	30 5/8
WC1536	MD	9 5/8	30 5/8	8 3/4	29 3/4	11 1/4	32 1/4	9 5/8	30 5/8
WC1542	GL	9 5/8	36 5/8	8 3/4	35 3/4	11 1/4	38 1/4	9 5/8	36 5/8
WC1542	MD	9 5/8	36 5/8	8 3/4	35 3/4	11 1/4	38 1/4	9 5/8	36 5/8
WC1824	GL	12 5/8	18 5/8	11 3/4	17 3/4	14 1/4	20 1/4	12 5/8	18 5/8
WC1824	MD	12 5/8	18 5/8	11 3/4	17 3/4	14 1/4	20 1/4	12 5/8	18 5/8
WC1830	GL	12 5/8	24 5/8	11 3/4	23 3/4	14 1/4	26 1/4	12 5/8	24 5/8
WC1830	MD	12 5/8	24 5/8	11 3/4	23 3/4	14 1/4	26 1/4	12 5/8	24 5/8
WC1836	GL	12 5/8	30 5/8	11 3/4	29 3/4	14 1/4	32 1/4	12 5/8	30 5/8
WC1836	MD	12 5/8	30 5/8	11 3/4	29 3/4	14 1/4	32 1/4	12 5/8	30 5/8
WC1842	GL	12 5/8	36 5/8	11 3/4	35 3/4	14 1/4	38 1/4	12 5/8	36 5/8
WC1842	MD	12 5/8	36 5/8	11 3/4	35 3/4	14 1/4	38 1/4	12 5/8	36 5/8
WC2118	GL	15 5/8	12 5/8	14 3/4	11 3/4	17 1/4	14 1/4	15 5/8	12 5/8
WC2118	MD	15 5/8	12 5/8	14 3/4	11 3/4	17 1/4	14 1/4	15 5/8	12 5/8
WC2124	GL	15 5/8	18 5/8	14 3/4	17 3/4	17 1/4	20 1/4	15 5/8	18 5/8
WC2124	MD	15 5/8	18 5/8	14 3/4	17 3/4	17 1/4	20 1/4	15 5/8	18 5/8
WC2130	GL	15 5/8	24 5/8	14 3/4	23 3/4	17 1/4	26 1/4	15 5/8	24 5/8
WC2130	MD	15 5/8	24 5/8	14 3/4	23 3/4	17 1/4	26 1/4	15 5/8	24 5/8
WC2136	GL	15 5/8	30 5/8	14 3/4	29 3/4	17 1/4	32 1/4	15 5/8	30 5/8
WC2136	MD	15 5/8	30 5/8	14 3/4	29 3/4	17 1/4	32 1/4	15 5/8	30 5/8
WC2142	GL	15 5/8	36 5/8	14 3/4	35 3/4	17 1/4	38 1/4	15 5/8	36 5/8
WC2142	MD	15 5/8	36 5/8	14 3/4	35 3/4	17 1/4	38 1/4	15 5/8	36 5/8
WC2418	GL	18 5/8	12 5/8	17 3/4	11 3/4	20 1/4	14 1/4	18 5/8	12 5/8
WC2418	MD	18 5/8	12 5/8	17 3/4	11 3/4	20 1/4	14 1/4	18 5/8	12 5/8
WC2418BP	GL	7 9/16	12 5/8	6 11/16	11 3/4	8 3/8	14 1/4	6 3/4	12 5/8
WC2418BP	MD	7 9/16	12 5/8	6 11/16	11 3/4	8 3/8	14 1/4	6 3/4	12 5/8
WC2424	GL	18 5/8	18 5/8	17 3/4	17 3/4	20 1/4	20 1/4	18 5/8	18 5/8
WC2424	MD	18 5/8	18 5/8	17 3/4	17 3/4	20 1/4	20 1/4	18 5/8	18 5/8
WC2424BP	GL	7 9/16	18 5/8	6 11/16	17 3/4	8 3/8	20 1/4	6 3/4	18 5/8
WC2424BP	MD	7 9/16	18 5/8	6 11/16	17 3/4	8 3/8	20 1/4	6 3/4	18 5/8
WC2430	GL	18 5/8	24 5/8	17 3/4	23 3/4	20 1/4	26 1/4	18 5/8	24 5/8
WC2430	MD	18 5/8	24 5/8	17 3/4	23 3/4	20 1/4	26 1/4	18 5/8	24 5/8
WC2430BP	GL	7 9/16	24 5/8	6 11/16	23 3/4	8 3/8	26 1/4	6 3/4	24 5/8
WC2430BP	MD	7 9/16	24 5/8	6 11/16	23 3/4	8 3/8	26 1/4	6 3/4	24 5/8
WC2436	GL	18 5/8	30 5/8	17 3/4	29 3/4	20 1/4	32 1/4	18 5/8	30 5/8
WC2436	MD	18 5/8	30 5/8	17 3/4	29 3/4	20 1/4	32 1/4	18 5/8	30 5/8
WC2436BP	GL	7 9/16	30 5/8	6 11/16	29 3/4	8 3/8	32 1/4	6 3/4	30 5/8
WC2436BP	MD	7 9/16	30 5/8	6 11/16	29 3/4	8 3/8	32 1/4	6 3/4	30 5/8
WC2442	GL	18 5/8	36 5/8	17 3/4	35 3/4	20 1/4	38 1/4	18 5/8	36 5/8
WC2442	MD	18 5/8	36 5/8	17 3/4	35 3/4	20 1/4	38 1/4	18 5/8	36 5/8
WC2442BP	GL	7 9/16	36 5/8	6 11/16	35 3/4	8 3/8	38 1/4	6 3/4	36 5/8
WC2442BP	MD	7 9/16	36 5/8	6 11/16	35 3/4	8 3/8	38 1/4	6 3/4	36 5/8
WC2718	GL	8 1/8	12 5/8	7 1/4	11 3/4	9 3/4	14 1/4	8 1/8	12 5/8
WC2718	MD	8 1/8	12 5/8	7 1/4	11 3/4	9 3/4	14 1/4	8 1/8	12 5/8

SUPPLEMENTAL PARTS – GLASS

		BELWOOD, CAMBRIDGE, ATLANTA, BRUNSWICK, FLORENCE, PARKWOOD		FAIRMONT		SAVANNAH, JAMESTON, WILMINGTON, CHARLESTON, ARLINGTON, NANTUCKET		SUMMERFIELD, JEFFERSON, WENTWORTH, ARDMORE, TRENTON, NORTHBROOK, ARCADIA	
SKU	TYPE	WIDTH	HEIGHT	WIDTH	HEIGHT	WIDTH	HEIGHT	WIDTH	HEIGHT
WC2718BP	GL	9 1/16	12 5/8	8 3/16	11 3/4	9 7/8	14 1/4	8 1/4	12 5/8
WC2718BP	MD	9 1/16	12 5/8	8 3/16	11 3/4	9 7/8	14 1/4	8 1/4	12 5/8
WC2724	GL	8 1/8	18 5/8	7 1/4	17 3/4	9 3/4	20 1/4	8 1/8	18 5/8
WC2724	MD	8 1/8	18 5/8	7 1/4	17 3/4	9 3/4	20 1/4	8 1/8	18 5/8
WC2724BP	GL	9 1/16	18 5/8	8 3/16	17 3/4	9 7/8	20 1/4	8 1/4	18 5/8
WC2724BP	MD	9 1/16	18 5/8	8 3/16	17 3/4	9 7/8	20 1/4	8 1/4	18 5/8
WC2730	GL	8 1/8	24 5/8	7 1/4	23 3/4	9 3/4	26 1/4	8 1/8	24 5/8
WC2730	MD	8 1/8	24 5/8	7 1/4	23 3/4	9 3/4	26 1/4	8 1/8	24 5/8
WC2730BP	GL	9 1/16	24 5/8	8 3/16	23 3/4	9 7/8	26 1/4	8 1/4	24 5/8
WC2730BP	MD	9 1/16	24 5/8	8 3/16	23 3/4	9 7/8	26 1/4	8 1/4	24 5/8
WC2736	GL	8 1/8	30 5/8	7 1/4	29 3/4	9 3/4	32 1/4	8 1/8	30 5/8
WC2736	MD	8 1/8	30 5/8	7 1/4	29 3/4	9 3/4	32 1/4	8 1/8	30 5/8
WC2736BP	GL	9 1/16	30 5/8	8 3/16	29 3/4	9 7/8	32 1/4	8 1/4	30 5/8
WC2736BP	MD	9 1/16	30 5/8	8 3/16	29 3/4	9 7/8	32 1/4	8 1/4	30 5/8
WC2742	GL	8 1/8	36 5/8	7 1/4	35 3/4	9 3/4	38 1/4	8 1/8	36 5/8
WC2742	MD	8 1/8	36 5/8	7 1/4	35 3/4	9 3/4	38 1/4	8 1/8	36 5/8
WC2742BP	GL	9 1/16	36 5/8	8 3/16	35 3/4	9 7/8	38 1/4	8 1/4	36 5/8
WC2742BP	MD	9 1/16	36 5/8	8 3/16	35 3/4	9 7/8	38 1/4	8 1/4	36 5/8
WC3012	GL	9 5/8	6 5/8	8 3/4	5 3/4	11 1/4	8 1/4	9 5/8	6 5/8
WC3012	MD	9 5/8	6 5/8	8 3/4	5 3/4	11 1/4	8 1/4	9 5/8	6 5/8
WC3012BP	GL	10 9/16	6 5/8	9 11/16	5 3/4	11 3/8	8 1/4	9 3/4	6 5/8
WC3012BP	MD	10 9/16	6 5/8	9 11/16	5 3/4	11 3/8	8 1/4	9 3/4	6 5/8
WC3015	GL	9 5/8	9 5/8	8 3/4	8 3/4	11 1/4	11 1/4	9 5/8	9 5/8
WC3015	MD	9 5/8	9 5/8	8 3/4	8 3/4	11 1/4	11 1/4	9 5/8	9 5/8
WC3015BP	GL	10 9/16	9 5/8	9 11/16	8 3/4	11 3/8	11 1/4	9 3/4	9 5/8
WC3015BP	MD	10 9/16	9 5/8	9 11/16	8 3/4	11 3/8	11 1/4	9 3/4	9 5/8
WC3018	GL	9 5/8	12 5/8	8 3/4	11 3/4	11 1/4	14 1/4	9 5/8	12 5/8
WC3018	MD	9 5/8	12 5/8	8 3/4	11 3/4	11 1/4	14 1/4	9 5/8	12 5/8
WC3018BP	GL	10 9/16	12 5/8	9 11/16	11 3/4	11 3/8	14 1/4	9 3/4	12 5/8
WC3018BP	MD	10 9/16	12 5/8	9 11/16	11 3/4	11 3/8	14 1/4	9 3/4	12 5/8
WC3021	GL	9 5/8	15 5/8	8 3/4	14 3/4	11 1/4	17 1/4	9 5/8	15 5/8
WC3021	MD	9 5/8	15 5/8	8 3/4	14 3/4	11 1/4	17 1/4	9 5/8	15 5/8
WC3021BP	GL	10 9/16	15 5/8	9 11/16	14 3/4	11 3/8	17 1/4	9 3/4	15 5/8
WC3021BP	MD	10 9/16	15 5/8	9 11/16	14 3/4	11 3/8	17 1/4	9 3/4	15 5/8
WC3024	GL	9 5/8	18 5/8	8 3/4	17 3/4	11 1/4	20 1/4	9 5/8	18 5/8
WC3024	MD	9 5/8	18 5/8	8 3/4	17 3/4	11 1/4	20 1/4	9 5/8	18 5/8
WC3024BP	GL	10 9/16	18 5/8	9 11/16	17 3/4	11 3/8	20 1/4	9 3/4	18 5/8
WC3024BP	MD	10 9/16	18 5/8	9 11/16	17 3/4	11 3/8	20 1/4	9 3/4	18 5/8
WC3027	GL	9 5/8	21 5/8	8 3/4	20 3/4	11 1/4	23 1/4	9 5/8	21 5/8
WC3027	MD	9 5/8	21 5/8	8 3/4	20 3/4	11 1/4	23 1/4	9 5/8	21 5/8
WC3030	GL	9 5/8	24 5/8	8 3/4	23 3/4	11 1/4	26 1/4	9 5/8	24 5/8
WC3030	MD	9 5/8	24 5/8	8 3/4	23 3/4	11 1/4	26 1/4	9 5/8	24 5/8
WC3030BP	GL	10 9/16	24 5/8	9 11/16	23 3/4	11 3/8	26 1/4	9 3/4	24 5/8
WC3030BP	MD	10 9/16	24 5/8	9 11/16	23 3/4	11 3/8	26 1/4	9 3/4	24 5/8
WC3036	GL	9 5/8	30 5/8	8 3/4	29 3/4	11 1/4	32 1/4	9 5/8	30 5/8
WC3036	MD	9 5/8	30 5/8	8 3/4	29 3/4	11 1/4	32 1/4	9 5/8	30 5/8
WC3036BP	GL	10 9/16	30 5/8	9 11/16	29 3/4	11 3/8	32 1/4	9 3/4	30 5/8
WC3036BP	MD	10 9/16	30 5/8	9 11/16	29 3/4	11 3/8	32 1/4	9 3/4	30 5/8
WC3042	GL	9 5/8	36 5/8	8 3/4	35 3/4	11 1/4	38 1/4	9 5/8	36 5/8
WC3042	MD	9 5/8	36 5/8	8 3/4	35 3/4	11 1/4	38 1/4	9 5/8	36 5/8

SUPPLEMENTAL PARTS – GLASS

		BELWOOD, CAMBRIDGE, ATLANTA, BRUNSWICK, FLORENCE, PARKWOOD		FAIRMONT		SAVANNAH, JAMESTON, WILMINGTON, CHARLESTON, ARLINGTON, NANTUCKET		SUMMERFIELD, JEFFERSON, WENTWORTH, ARDMORE, TRENTON, NORTHBROOK, ARCADIA	
SKU	TYPE	WIDTH	HEIGHT	WIDTH	HEIGHT	WIDTH	HEIGHT	WIDTH	HEIGHT
WC3042BP	GL	10 9/16	36 5/8	9 11/16	35 3/4	11 3/8	38 1/4	9 3/4	36 5/8
WC3042BP	MD	10 9/16	36 5/8	9 11/16	35 3/4	11 3/8	38 1/4	9 3/4	36 5/8
WC3312	GL	11 1/8	6 5/8	10 1/4	5 3/4	12 3/4	8 1/4	11 1/8	6 5/8
WC3312	MD	11 1/8	6 5/8	10 1/4	5 3/4	12 3/4	8 1/4	11 1/8	6 5/8
WC3312BP	GL	12 1/16	6 5/8	11 3/16	5 3/4	12 7/8	8 1/4	11 1/4	6 5/8
WC3312BP	MD	12 1/16	6 5/8	11 3/16	5 3/4	12 7/8	8 1/4	11 1/4	6 5/8
WC3315	GL	11 1/8	9 5/8	10 1/4	8 3/4	12 3/4	11 1/4	11 1/8	9 5/8
WC3315	MD	11 1/8	9 5/8	10 1/4	8 3/4	12 3/4	11 1/4	11 1/8	9 5/8
WC3315BP	GL	12 1/16	9 5/8	11 3/16	8 3/4	12 7/8	11 1/4	11 1/4	9 5/8
WC3315BP	MD	12 1/16	9 5/8	11 3/16	8 3/4	12 7/8	11 1/4	11 1/4	9 5/8
WC3318	GL	11 1/8	12 5/8	10 1/4	11 3/4	12 3/4	14 1/4	11 1/8	12 5/8
WC3318	MD	11 1/8	12 5/8	10 1/4	11 3/4	12 3/4	14 1/4	11 1/8	12 5/8
WC3318BP	GL	12 1/16	12 5/8	11 3/16	11 3/4	12 7/8	14 1/4	11 1/4	12 5/8
WC3318BP	MD	12 1/16	12 5/8	11 3/16	11 3/4	12 7/8	14 1/4	11 1/4	12 5/8
WC3321	GL	11 1/8	15 5/8	10 1/4	14 3/4	12 3/4	17 1/4	11 1/8	15 5/8
WC3321	MD	11 1/8	15 5/8	10 1/4	14 3/4	12 3/4	17 1/4	11 1/8	15 5/8
WC3321BP	GL	12 1/16	15 5/8	11 3/16	14 3/4	12 7/8	17 1/4	11 1/4	15 5/8
WC3321BP	MD	12 1/16	15 5/8	11 3/16	14 3/4	12 7/8	17 1/4	11 1/4	15 5/8
WC3324	GL	11 1/8	18 5/8	10 1/4	17 3/4	12 3/4	20 1/4	11 1/8	18 5/8
WC3324	MD	11 1/8	18 5/8	10 1/4	17 3/4	12 3/4	20 1/4	11 1/8	18 5/8
WC3324BP	GL	12 1/16	18 5/8	11 3/16	17 3/4	12 7/8	20 1/4	11 1/4	18 5/8
WC3324BP	MD	12 1/16	18 5/8	11 3/16	17 3/4	12 7/8	20 1/4	11 1/4	18 5/8
WC3330	GL	11 1/8	24 5/8	10 1/4	23 3/4	12 3/4	26 1/4	11 1/8	24 5/8
WC3330	MD	11 1/8	24 5/8	10 1/4	23 3/4	12 3/4	26 1/4	11 1/8	24 5/8
WC3330BP	GL	12 1/16	24 5/8	11 3/16	23 3/4	12 7/8	26 1/4	11 1/4	24 5/8
WC3330BP	MD	12 1/16	24 5/8	11 3/16	23 3/4	12 7/8	26 1/4	11 1/4	24 5/8
WC3336	GL	11 1/8	30 5/8	10 1/4	29 3/4	12 3/4	32 1/4	11 1/8	30 5/8
WC3336	MD	11 1/8	30 5/8	10 1/4	29 3/4	12 3/4	32 1/4	11 1/8	30 5/8
WC3336BP	GL	12 1/16	30 5/8	11 3/16	29 3/4	12 7/8	32 1/4	11 1/4	30 5/8
WC3336BP	MD	12 1/16	30 5/8	11 3/16	29 3/4	12 7/8	32 1/4	11 1/4	30 5/8
WC3342	GL	11 1/8	36 5/8	10 1/4	35 3/4	12 3/4	38 1/4	11 1/8	36 5/8
WC3342	MD	11 1/8	36 5/8	10 1/4	35 3/4	12 3/4	38 1/4	11 1/8	36 5/8
WC3342BP	GL	12 1/16	36 5/8	11 3/16	35 3/4	12 7/8	38 1/4	11 1/4	36 5/8
WC3342BP	MD	12 1/16	36 5/8	11 3/16	35 3/4	12 7/8	38 1/4	11 1/4	36 5/8
WC3612	GL	12 5/8	6 5/8	11 3/4	5 3/4	14 1/4	8 1/4	12 5/8	6 5/8
WC3612	MD	12 5/8	6 5/8	11 3/4	5 3/4	14 1/4	8 1/4	12 5/8	6 5/8
WC3612BP	GL	13 9/16	6 5/8	12 11/16	5 3/4	14 3/8	8 1/4	12 3/4	6 5/8
WC3612BP	MD	13 9/16	6 5/8	12 11/16	5 3/4	14 3/8	8 1/4	12 3/4	6 5/8
WC3615	GL	12 5/8	9 5/8	11 3/4	8 3/4	14 1/4	11 1/4	12 5/8	9 5/8
WC3615	MD	12 5/8	9 5/8	11 3/4	8 3/4	14 1/4	11 1/4	12 5/8	9 5/8
WC3615BP	GL	13 9/16	9 5/8	12 11/16	8 3/4	14 3/8	11 1/4	12 3/4	9 5/8
WC3615BP	MD	13 9/16	9 5/8	12 11/16	8 3/4	14 3/8	11 1/4	12 3/4	9 5/8
WC3618	GL	12 5/8	12 5/8	11 3/4	11 3/4	14 1/4	14 1/4	12 5/8	12 5/8
WC3618	MD	12 5/8	12 5/8	11 3/4	11 3/4	14 1/4	14 1/4	12 5/8	12 5/8
WC3618BP	GL	13 9/16	12 5/8	12 11/16	11 3/4	14 3/8	14 1/4	12 3/4	12 5/8
WC3618BP	MD	13 9/16	12 5/8	12 11/16	11 3/4	14 3/8	14 1/4	12 3/4	12 5/8
WC3621	GL	12 5/8	15 5/8	11 3/4	14 3/4	14 1/4	17 1/4	12 5/8	15 5/8
WC3621	MD	12 5/8	15 5/8	11 3/4	14 3/4	14 1/4	17 1/4	12 5/8	15 5/8
WC3621BP	GL	13 9/16	15 5/8	12 11/16	14 3/4	14 3/8	17 1/4	12 3/4	15 5/8
WC3621BP	MD	13 9/16	15 5/8	12 11/16	14 3/4	14 3/8	17 1/4	12 3/4	15 5/8

SUPPLEMENTAL PARTS – GLASS

		BELWOOD, CAMBRIDGE, ATLANTA, BRUNSWICK, FLORENCE, PARKWOOD		FAIRMONT		SAVANNAH, JAMESTON, WILMINGTON, CHARLESTON, ARLINGTON, NANTUCKET		SUMMERFIELD, JEFFERSON, WENTWORTH, ARDMORE, TRENTON, NORTHBROOK, ARCADIA	
SKU	TYPE	WIDTH	HEIGHT	WIDTH	HEIGHT	WIDTH	HEIGHT	WIDTH	HEIGHT
WC3624	GL	12 5/8	18 5/8	11 3/4	17 3/4	14 1/4	20 1/4	12 5/8	18 5/8
WC3624	MD	12 5/8	18 5/8	11 3/4	17 3/4	14 1/4	20 1/4	12 5/8	18 5/8
WC3624BP	GL	13 9/16	18 5/8	12 11/16	17 3/4	14 3/8	20 1/4	12 3/4	18 5/8
WC3624BP	MD	13 9/16	18 5/8	12 11/16	17 3/4	14 3/8	20 1/4	12 3/4	18 5/8
WC3630	GL	12 5/8	24 5/8	11 3/4	23 3/4	14 1/4	26 1/4	12 5/8	24 5/8
WC3630	MD	12 5/8	24 5/8	11 3/4	23 3/4	14 1/4	26 1/4	12 5/8	24 5/8
WC3630BP	GL	13 9/16	24 5/8	12 11/16	23 3/4	14 3/8	26 1/4	12 3/4	24 5/8
WC3630BP	MD	13 9/16	24 5/8	12 11/16	23 3/4	14 3/8	26 1/4	12 3/4	24 5/8
WC3636	GL	12 5/8	30 5/8	11 3/4	29 3/4	14 1/4	32 1/4	12 5/8	30 5/8
WC3636	MD	12 5/8	30 5/8	11 3/4	29 3/4	14 1/4	32 1/4	12 5/8	30 5/8
WC3636BP	GL	13 9/16	30 5/8	12 11/16	29 3/4	14 3/8	32 1/4	12 3/4	30 5/8
WC3636BP	MD	13 9/16	30 5/8	12 11/16	29 3/4	14 3/8	32 1/4	12 3/4	30 5/8
WC3642	GL	12 5/8	36 5/8	11 3/4	35 3/4	14 1/4	38 1/4	12 5/8	36 5/8
WC3642	MD	12 5/8	36 5/8	11 3/4	35 3/4	14 1/4	38 1/4	12 5/8	36 5/8
WC3642BP	GL	13 9/16	36 5/8	12 11/16	35 3/4	14 3/8	38 1/4	12 3/4	36 5/8
WC3642BP	MD	13 9/16	36 5/8	12 11/16	35 3/4	14 3/8	38 1/4	12 3/4	36 5/8
WC3912	GL	14 1/8	6 5/8	13 1/4	5 3/4	15 3/4	8 1/4	14 1/8	6 5/8
WC3912	MD	14 1/8	6 5/8	13 1/4	5 3/4	15 3/4	8 1/4	14 1/8	6 5/8
WC3912BP	GL	15 1/16	6 5/8	14 3/16	5 3/4	15 7/8	8 1/4	14 1/4	6 5/8
WC3912BP	MD	15 1/16	6 5/8	14 3/16	5 3/4	15 7/8	8 1/4	14 1/4	6 5/8
WC3915	GL	14 1/8	9 5/8	13 1/4	8 3/4	15 3/4	11 1/4	14 1/8	9 5/8
WC3915	MD	14 1/8	9 5/8	13 1/4	8 3/4	15 3/4	11 1/4	14 1/8	9 5/8
WC3915BP	GL	15 1/16	9 5/8	14 3/16	8 3/4	15 7/8	11 1/4	14 1/4	9 5/8
WC3915BP	MD	15 1/16	9 5/8	14 3/16	8 3/4	15 7/8	11 1/4	14 1/4	9 5/8
WC3918	GL	14 1/8	12 5/8	13 1/4	11 3/4	15 3/4	14 1/4	14 1/8	12 5/8
WC3918	MD	14 1/8	12 5/8	13 1/4	11 3/4	15 3/4	14 1/4	14 1/8	12 5/8
WC3918BP	GL	15 1/16	12 5/8	14 3/16	11 3/4	15 7/8	14 1/4	14 1/4	12 5/8
WC3918BP	MD	15 1/16	12 5/8	14 3/16	11 3/4	15 7/8	14 1/4	14 1/4	12 5/8
WC3921	GL	14 1/8	15 5/8	13 1/4	14 3/4	15 3/4	17 1/4	14 1/8	15 5/8
WC3921	MD	14 1/8	15 5/8	13 1/4	14 3/4	15 3/4	17 1/4	14 1/8	15 5/8
WC3921BP	GL	15 1/16	15 5/8	14 3/16	14 3/4	15 7/8	17 1/4	14 1/4	15 5/8
WC3921BP	MD	15 1/16	15 5/8	14 3/16	14 3/4	15 7/8	17 1/4	14 1/4	15 5/8
WC3924	GL	14 1/8	18 5/8	13 1/4	17 3/4	15 3/4	20 1/4	14 1/8	18 5/8
WC3924	MD	14 1/8	18 5/8	13 1/4	17 3/4	15 3/4	20 1/4	14 1/8	18 5/8
WC3924BP	GL	15 1/16	18 5/8	14 3/16	17 3/4	15 7/8	20 1/4	14 1/4	18 5/8
WC3924BP	MD	15 1/16	18 5/8	14 3/16	17 3/4	15 7/8	20 1/4	14 1/4	18 5/8
WC3930	GL	14 1/8	24 5/8	13 1/4	23 3/4	15 3/4	26 1/4	14 1/8	24 5/8
WC3930	MD	14 1/8	24 5/8	13 1/4	23 3/4	15 3/4	26 1/4	14 1/8	24 5/8
WC3936	GL	14 1/8	30 5/8	13 1/4	29 3/4	15 3/4	32 1/4	14 1/8	30 5/8
WC3936	MD	14 1/8	30 5/8	13 1/4	29 3/4	15 3/4	32 1/4	14 1/8	30 5/8
WC3942	GL	14 1/8	36 5/8	13 1/4	35 3/4	15 3/4	38 1/4	14 1/8	36 5/8
WC3942	MD	14 1/8	36 5/8	13 1/4	35 3/4	15 3/4	38 1/4	14 1/8	36 5/8
WC4218	GL	15 5/8	12 5/8	14 3/4	11 3/4	17 1/4	14 1/4	15 5/8	12 5/8
WC4218	MD	15 5/8	12 5/8	14 3/4	11 3/4	17 1/4	14 1/4	15 5/8	12 5/8
WC4224	GL	15 5/8	18 5/8	14 3/4	17 3/4	17 1/4	20 1/4	15 5/8	18 5/8
WC4224	MD	15 5/8	18 5/8	14 3/4	17 3/4	17 1/4	20 1/4	15 5/8	18 5/8
WC4230	GL	15 5/8	24 5/8	14 3/4	23 3/4	17 1/4	26 1/4	15 5/8	24 5/8
WC4230	MD	15 5/8	24 5/8	14 3/4	23 3/4	17 1/4	26 1/4	15 5/8	24 5/8
WC4236	GL	15 5/8	30 5/8	14 3/4	29 3/4	17 1/4	32 1/4	15 5/8	30 5/8
WC4236	MD	15 5/8	30 5/8	14 3/4	29 3/4	17 1/4	32 1/4	15 5/8	30 5/8

SUPPLEMENTAL PARTS – GLASS

		BELWOOD, CAMBRIDGE, ATLANTA, BRUNSWICK, FLORENCE, PARKWOOD		FAIRMONT		SAVANNAH, JAMESTON, WILMINGTON, CHARLESTON, ARLINGTON, NANTUCKET		SUMMERFIELD, JEFFERSON, WENTWORTH, ARDMORE, TRENTON, NORTHBROOK, ARCADIA	
SKU	TYPE	WIDTH	HEIGHT	WIDTH	HEIGHT	WIDTH	HEIGHT	WIDTH	HEIGHT
WC4242	GL	15 5/8	36 5/8	14 3/4	35 3/4	17 1/4	38 1/4	15 5/8	36 5/8
WC4242	MD	15 5/8	36 5/8	14 3/4	35 3/4	17 1/4	38 1/4	15 5/8	36 5/8
WC4524	GL	17 1/8	18 5/8	16 1/4	17 3/4	18 3/4	20 1/4	17 1/8	18 5/8
WC4524	MD	17 1/8	18 5/8	16 1/4	17 3/4	18 3/4	20 1/4	17 1/8	18 5/8
WC4530	GL	17 1/8	24 5/8	16 1/4	23 3/4	18 3/4	26 1/4	17 1/8	24 5/8
WC4530	MD	17 1/8	24 5/8	16 1/4	23 3/4	18 3/4	26 1/4	17 1/8	24 5/8
WC4536	GL	17 1/8	30 5/8	16 1/4	29 3/4	18 3/4	32 1/4	17 1/8	30 5/8
WC4536	MD	17 1/8	30 5/8	16 1/4	29 3/4	18 3/4	32 1/4	17 1/8	30 5/8
WC4542	GL	17 1/8	36 5/8	16 1/4	35 3/4	18 3/4	38 1/4	17 1/8	36 5/8
WC4542	MD	17 1/8	36 5/8	16 1/4	35 3/4	18 3/4	38 1/4	17 1/8	36 5/8
WC4824	GL	18 5/8	18 5/8	17 3/4	17 3/4	20 1/4	20 1/4	18 5/8	18 5/8
WC4824	MD	18 5/8	18 5/8	17 3/4	17 3/4	20 1/4	20 1/4	18 5/8	18 5/8
WC4830	GL	18 5/8	24 5/8	17 3/4	23 3/4	20 1/4	26 1/4	18 5/8	24 5/8
WC4830	MD	18 5/8	24 5/8	17 3/4	23 3/4	20 1/4	26 1/4	18 5/8	24 5/8
WC4836	GL	18 5/8	30 5/8	17 3/4	29 3/4	20 1/4	32 1/4	18 5/8	30 5/8
WC4836	MD	18 5/8	30 5/8	17 3/4	29 3/4	20 1/4	32 1/4	18 5/8	30 5/8
WC4842	GL	18 5/8	36 5/8	17 3/4	35 3/4	20 1/4	38 1/4	18 5/8	36 5/8
WC4842	MD	18 5/8	36 5/8	17 3/4	35 3/4	20 1/4	38 1/4	18 5/8	36 5/8
WC924	GL	3 5/8	18 5/8	2 3/4	17 3/4	5 1/4	20 1/4	3 5/8	18 5/8
WC930	GL	3 5/8	24 5/8	2 3/4	23 3/4	5 1/4	26 1/4	3 5/8	24 5/8
WC936	GL	3 5/8	30 5/8	2 3/4	29 3/4	5 1/4	32 1/4	3 5/8	30 5/8
WC942	GL	3 5/8	36 5/8	2 3/4	35 3/4	5 1/4	38 1/4	3 5/8	36 5/8
WCC2424	GL	6 5/8	18 5/8	5 3/4	17 3/4	8 1/4	20 1/4	6 5/8	18 5/8
WCC2424	MD	6 5/8	18 5/8	5 3/4	17 3/4	8 1/4	20 1/4	6 5/8	18 5/8
WCC2430	GL	6 5/8	24 5/8	5 3/4	23 3/4	8 1/4	26 1/4	6 5/8	24 5/8
WCC2430	MD	6 5/8	24 5/8	5 3/4	23 3/4	8 1/4	26 1/4	6 5/8	24 5/8
WCC2436	GL	6 5/8	30 5/8	5 3/4	29 3/4	8 1/4	32 1/4	6 5/8	30 5/8
WCC2436	MD	6 5/8	30 5/8	5 3/4	29 3/4	8 1/4	32 1/4	6 5/8	30 5/8
WCC2442	GL	6 5/8	36 5/8	5 3/4	35 3/4	8 1/4	38 1/4	6 5/8	36 5/8
WCC2442	MD	6 5/8	36 5/8	5 3/4	35 3/4	8 1/4	38 1/4	6 5/8	36 5/8
WCC3024	GL	12 5/8	18 5/8	11 3/4	17 3/4	14 1/4	20 1/4	12 5/8	18 5/8
WCC3024	MD	12 5/8	18 5/8	11 3/4	17 3/4	14 1/4	20 1/4	12 5/8	18 5/8
WCC3030	GL	12 5/8	24 5/8	11 3/4	23 3/4	14 1/4	26 1/4	12 5/8	24 5/8
WCC3030	MD	12 5/8	24 5/8	11 3/4	23 3/4	14 1/4	26 1/4	12 5/8	24 5/8
WCC3036	GL	12 5/8	30 5/8	11 3/4	29 3/4	14 1/4	32 1/4	12 5/8	30 5/8
WCC3036	MD	12 5/8	30 5/8	11 3/4	29 3/4	14 1/4	32 1/4	12 5/8	30 5/8
WCC3042	GL	12 5/8	36 5/8	11 3/4	35 3/4	14 1/4	38 1/4	12 5/8	36 5/8
WCC3042	MD	12 5/8	36 5/8	11 3/4	35 3/4	14 1/4	38 1/4	12 5/8	36 5/8
WCC3624	GL	18 5/8	18 5/8	17 3/4	17 3/4	20 1/4	20 1/4	18 5/8	18 5/8
WCC3624	MD	18 5/8	18 5/8	17 3/4	17 3/4	20 1/4	20 1/4	18 5/8	18 5/8
WCC3630	GL	18 5/8	24 5/8	17 3/4	23 3/4	20 1/4	26 1/4	18 5/8	24 5/8
WCC3630	MD	18 5/8	24 5/8	17 3/4	23 3/4	20 1/4	26 1/4	18 5/8	24 5/8
WCC3636	GL	18 5/8	30 5/8	17 3/4	29 3/4	20 1/4	32 1/4	18 5/8	30 5/8
WCC3636	MD	18 5/8	30 5/8	17 3/4	29 3/4	20 1/4	32 1/4	18 5/8	30 5/8
WCC3642	GL	18 5/8	36 5/8	17 3/4	35 3/4	20 1/4	38 1/4	18 5/8	36 5/8
WCC3642	MD	18 5/8	36 5/8	17 3/4	35 3/4	20 1/4	38 1/4	18 5/8	36 5/8
WCC4230	GL	9 5/8	24 5/8	8 3/4	23 3/4	11 1/4	26 1/4	9 5/8	24 5/8
WCC4230	MD	9 5/8	24 5/8	8 3/4	23 3/4	11 1/4	26 1/4	9 5/8	24 5/8
WCC4236	GL	9 5/8	30 5/8	8 3/4	29 3/4	11 1/4	32 1/4	9 5/8	30 5/8
WCC4236	MD	9 5/8	30 5/8	8 3/4	29 3/4	11 1/4	32 1/4	9 5/8	30 5/8

SUPPLEMENTAL PARTS – GLASS

SKU	TYPE	BELWOOD, CAMBRIDGE, ATLANTA, BRUNSWICK, FLORENCE, PARKWOOD		FAIRMONT		SAVANNAH, JAMESTON, WILMINGTON, CHARLESTON, ARLINGTON, NANTUCKET		SUMMERFIELD, JEFFERSON, WENTWORTH, ARDMORE, TRENTON, NORTHBROOK, ARCADIA	
		WIDTH	HEIGHT	WIDTH	HEIGHT	WIDTH	HEIGHT	WIDTH	HEIGHT
WCC4242	GL	9 5/8	36 5/8	8 3/4	35 3/4	11 1/4	38 1/4	9 5/8	36 5/8
WCC4242	MD	9 5/8	36 5/8	8 3/4	35 3/4	11 1/4	38 1/4	9 5/8	36 5/8
WCC4830	GL	12 5/8	24 5/8	11 3/4	23 3/4	14 1/4	26 1/4	12 5/8	24 5/8
WCC4830	MD	12 5/8	24 5/8	11 3/4	23 3/4	14 1/4	26 1/4	12 5/8	24 5/8
WCC4836	GL	12 5/8	30 5/8	11 3/4	29 3/4	14 1/4	32 1/4	12 5/8	30 5/8
WCC4836	MD	12 5/8	30 5/8	11 3/4	29 3/4	14 1/4	32 1/4	12 5/8	30 5/8
WCC4842	GL	12 5/8	36 5/8	11 3/4	35 3/4	14 1/4	38 1/4	12 5/8	36 5/8
WCC4842	MD	12 5/8	36 5/8	11 3/4	35 3/4	14 1/4	38 1/4	12 5/8	36 5/8
WCMW2730	GL	8 1/8	6 5/8	7 1/4	5 3/4	9 3/4	8 1/4	8 1/8	6 5/8
WCMW2730	MD	8 1/8	6 5/8	7 1/4	5 3/4	9 3/4	8 1/4	8 1/8	6 5/8
WCMW2730BP	GL	9 1/16	6 5/8	8 3/16	5 3/4	9 7/8	8 1/4	8 1/4	6 5/8
WCMW2730BP	MD	9 1/16	6 5/8	8 3/16	5 3/4	9 7/8	8 1/4	8 1/4	6 5/8
WCMW2736	GL	8 1/8	12 5/8	7 1/4	11 3/4	9 3/4	14 1/4	8 1/8	12 5/8
WCMW2736	MD	8 1/8	12 5/8	7 1/4	11 3/4	9 3/4	14 1/4	8 1/8	12 5/8
WCMW2736BP	GL	9 1/16	12 5/8	8 3/16	11 3/4	9 7/8	14 1/4	8 1/4	12 5/8
WCMW2736BP	MD	9 1/16	12 5/8	8 3/16	11 3/4	9 7/8	14 1/4	8 1/4	12 5/8
WCMW2742	GL	8 1/8	18 5/8	7 1/4	17 3/4	9 3/4	20 1/4	8 1/8	18 5/8
WCMW2742	MD	8 1/8	18 5/8	7 1/4	17 3/4	9 3/4	20 1/4	8 1/8	18 5/8
WCMW2742BP	GL	9 1/16	18 5/8	8 3/16	17 3/4	9 7/8	20 1/4	8 1/4	18 5/8
WCMW2742BP	MD	9 1/16	18 5/8	8 3/16	17 3/4	9 7/8	20 1/4	8 1/4	18 5/8
WCMW3030	GL	9 5/8	6 5/8	8 3/4	5 3/4	11 1/4	8 1/4	9 5/8	6 5/8
WCMW3030	MD	9 5/8	6 5/8	8 3/4	5 3/4	11 1/4	8 1/4	9 5/8	6 5/8
WCMW3030BP	GL	10 9/16	6 5/8	9 11/16	5 3/4	11 3/8	8 1/4	9 3/4	6 5/8
WCMW3030BP	MD	10 9/16	6 5/8	9 11/16	5 3/4	11 3/8	8 1/4	9 3/4	6 5/8
WCMW3036	GL	9 5/8	12 5/8	8 3/4	11 3/4	11 1/4	14 1/4	9 5/8	12 5/8
WCMW3036	MD	9 5/8	12 5/8	8 3/4	11 3/4	11 1/4	14 1/4	9 5/8	12 5/8
WCMW3036BP	GL	10 9/16	12 5/8	9 11/16	11 3/4	11 3/8	14 1/4	9 3/4	12 5/8
WCMW3036BP	MD	10 9/16	12 5/8	9 11/16	11 3/4	11 3/8	14 1/4	9 3/4	12 5/8
WCMW3042	GL	9 5/8	18 5/8	8 3/4	17 3/4	11 1/4	20 1/4	9 5/8	18 5/8
WCMW3042	MD	9 5/8	18 5/8	8 3/4	17 3/4	11 1/4	20 1/4	9 5/8	18 5/8
WCMW3042BP	GL	10 9/16	18 5/8	9 11/16	17 3/4	11 3/8	20 1/4	9 3/4	18 5/8
WCMW3042BP	MD	10 9/16	18 5/8	9 11/16	17 3/4	11 3/8	20 1/4	9 3/4	18 5/8
WEA1224	GL	3 5/8	18 5/8	2 3/4	17 3/4	5 1/4	20 1/4	3 5/8	18 5/8
WEA1230	GL	3 5/8	24 5/8	2 3/4	23 3/4	5 1/4	26 1/4	3 5/8	24 5/8
WEA1236	GL	3 5/8	30 5/8	2 3/4	29 3/4	5 1/4	32 1/4	3 5/8	30 5/8
WEA1242	GL	3 5/8	36 5/8	2 3/4	35 3/4	5 1/4	38 1/4	3 5/8	36 5/8
WEC1224	GL	10 1/4	18 5/8	9 3/8	17 3/4	11 7/8	20 1/4	10 1/4	18 5/8
WEC1224	MD	10 1/4	18 5/8	9 3/8	17 3/4	11 7/8	20 1/4	10 1/4	18 5/8
WEC1230	GL	10 1/4	24 5/8	9 3/8	23 3/4	11 7/8	26 1/4	10 1/4	24 5/8
WEC1230	MD	10 1/4	24 5/8	9 3/8	23 3/4	11 7/8	26 1/4	10 1/4	24 5/8
WEC1236	GL	10 1/4	30 5/8	9 3/8	29 3/4	11 7/8	32 1/4	10 1/4	30 5/8
WEC1236	MD	10 1/4	30 5/8	9 3/8	29 3/4	11 7/8	32 1/4	10 1/4	30 5/8
WEC1242	GL	10 1/4	36 5/8	9 3/8	35 3/4	11 7/8	38 1/4	10 1/4	36 5/8
WEC1242	MD	10 1/4	36 5/8	9 3/8	35 3/4	11 7/8	38 1/4	10 1/4	36 5/8



MARSH CABINETS

NOTES

NOTES



NOTES



MARSH FURNITURE COMPANY
P. O. Box 870
1001 South Centennial Street
High Point, North Carolina 27261-0870
Phone 336-884-7363
FAX 877-354-9266
www.marshfurniture.com



**Marsh Furniture Company reserves the right to
change specifications without advance notice.
Door and drawer hardware are optional items
to be ordered separately.**